



US00D597650S

(12) **United States Design Patent**
Orozco

(10) **Patent No.:** **US D597,650 S**

(45) **Date of Patent:** **** Aug. 4, 2009**

(54) **COMBINED CEILING FAN AND LIGHT KIT**

D566,258 S	4/2008	Bucher et al.
D566,259 S	4/2008	Bucher et al.
D572,814 S	7/2008	Bucher et al.
D573,242 S *	7/2008	Pan D23/377
D576,265 S	9/2008	Bucher et al.
D577,116 S	9/2008	Orozco

(75) Inventor: **Sergio Orozco**, New York, NY (US)

(73) Assignee: **Chien Luon Industries Co., Ltd. Inc.**,
Oakland Park, FL (US)

(**) Term: **14 Years**

* cited by examiner

(21) Appl. No.: **29/332,589**

Primary Examiner—Lisa P Lichtenstein
(74) *Attorney, Agent, or Firm*—Brian S. Steinberger; Law
Offices of Brian S. Steinberger, P.A.

(22) Filed: **Feb. 20, 2009**

(51) **LOC (9) Cl.** **23-04**

(52) **U.S. Cl.** **D23/377**

(58) **Field of Classification Search** D23/377,
D23/379, 385, 411, 413; 416/5; D26/59,
D26/72, 81–88

(57) **CLAIM**

See application file for complete search history.

The ornamental design for a combined ceiling fan and light
kit, as shown and described.

DESCRIPTION

(56) **References Cited**

U.S. PATENT DOCUMENTS

D364,224 S	11/1995	Wang	
D371,838 S	7/1996	Davis, Jr. et al.	
D378,404 S	3/1997	Jaspers-Fayer	
D402,026 S	12/1998	Chuang et al.	
D408,518 S	4/1999	Liu	
D411,295 S	6/1999	Evans	
D412,571 S	8/1999	Lee	
D414,856 S	10/1999	Zuege	
D421,799 S	3/2000	Zuege	
D422,072 S	3/2000	Blateri	
D433,498 S *	11/2000	Frampton D23/413	
D462,756 S	9/2002	Liu	
D480,471 S	10/2003	Hsieh	
D485,347 S	1/2004	Bucher et al.	
D553,731 S	10/2007	Bucher et al.	

FIG. 1 is a lower front perspective view of the ornamental
ceiling fan design with light and blades and blade arms.
FIG. 2 is an upper perspective view of the design of FIG. 1.
FIG. 3 is a front view of the design of FIG. 1.
FIG. 4 is a left side view of the design of FIG. 1.
FIG. 5 is a right side view of the design of FIG. 1.
FIG. 6 is a rear view of the first embodiment design of FIG. 1.
FIG. 7 is a bottom view of the design of FIG. 1; and,
FIG. 8 is a top view of the design of FIG. 1.

The broken line showing of a rod and ceiling mount cap, blade
fasteners, and pull chain with fob is included for the purpose
of illustrating environmental structure and forms no part of
the claimed design.

1 Claim, 8 Drawing Sheets

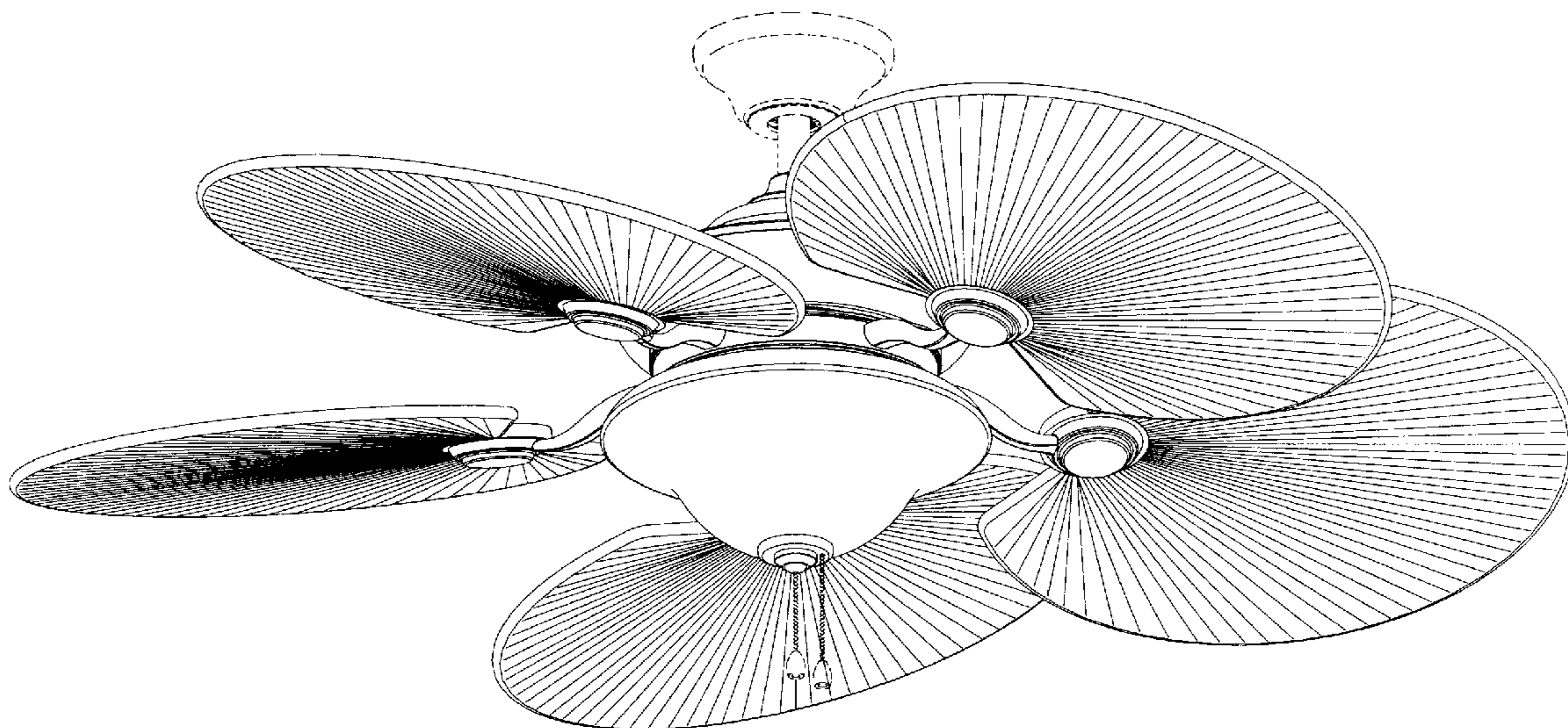

FIG. 1

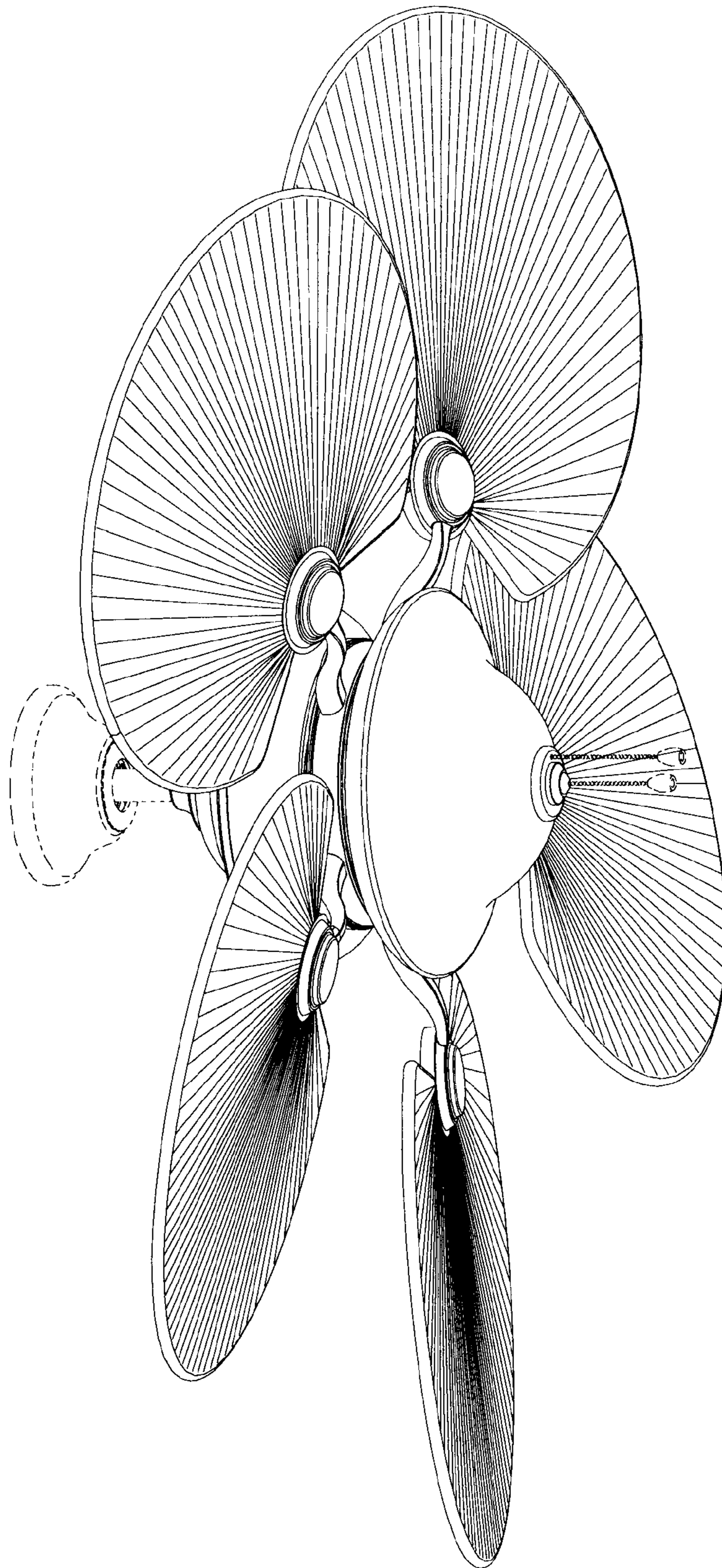

FIG. 2

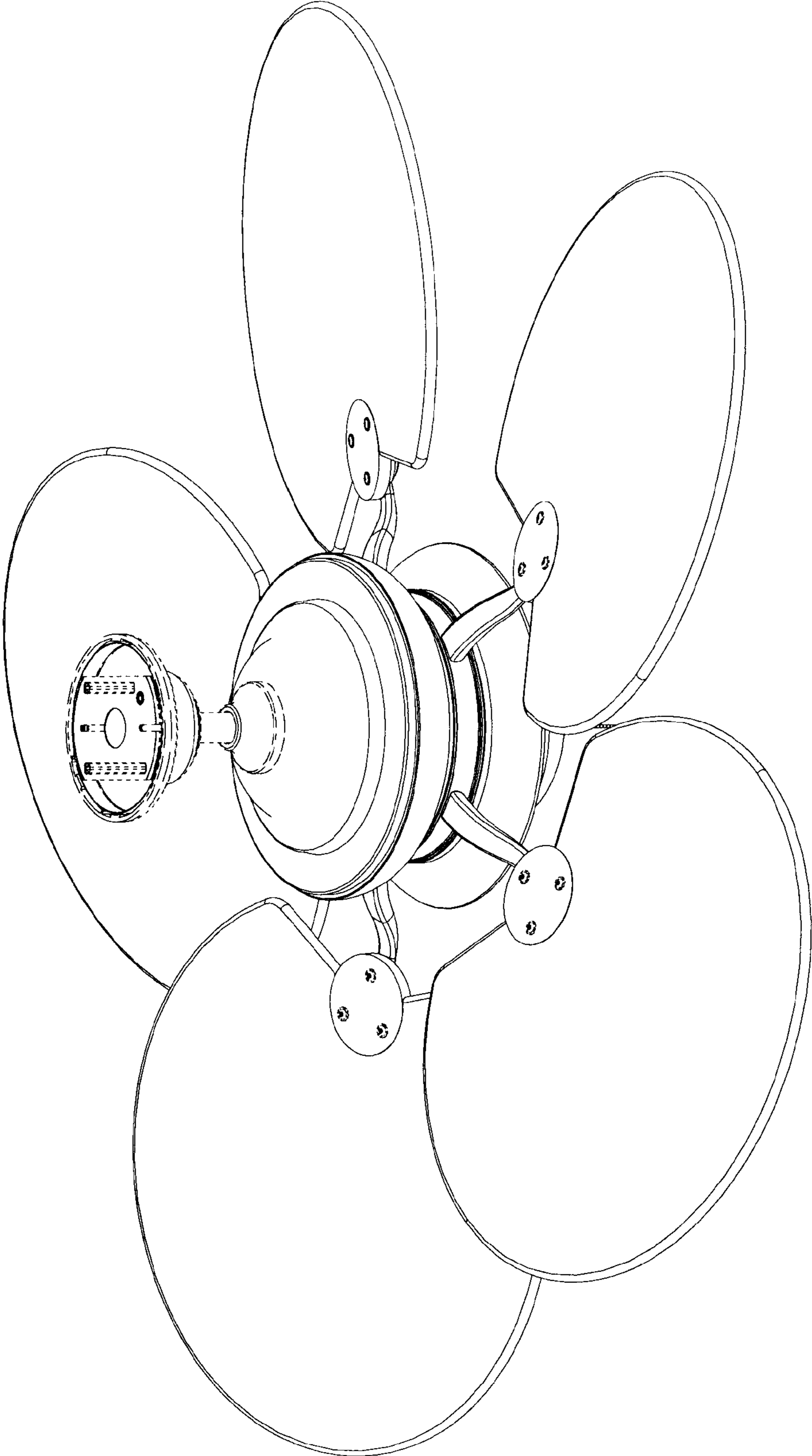

FIG. 3

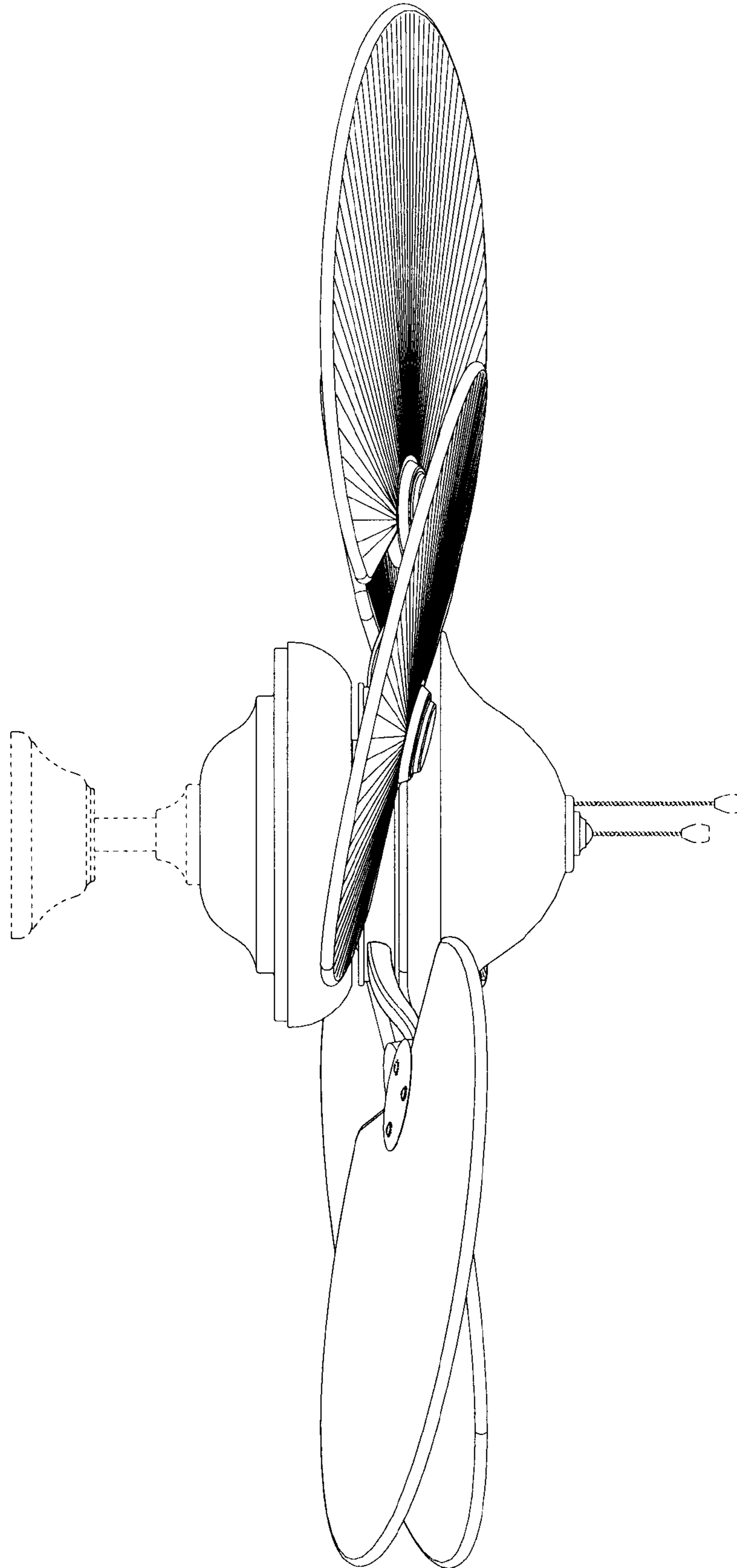

FIG. 4

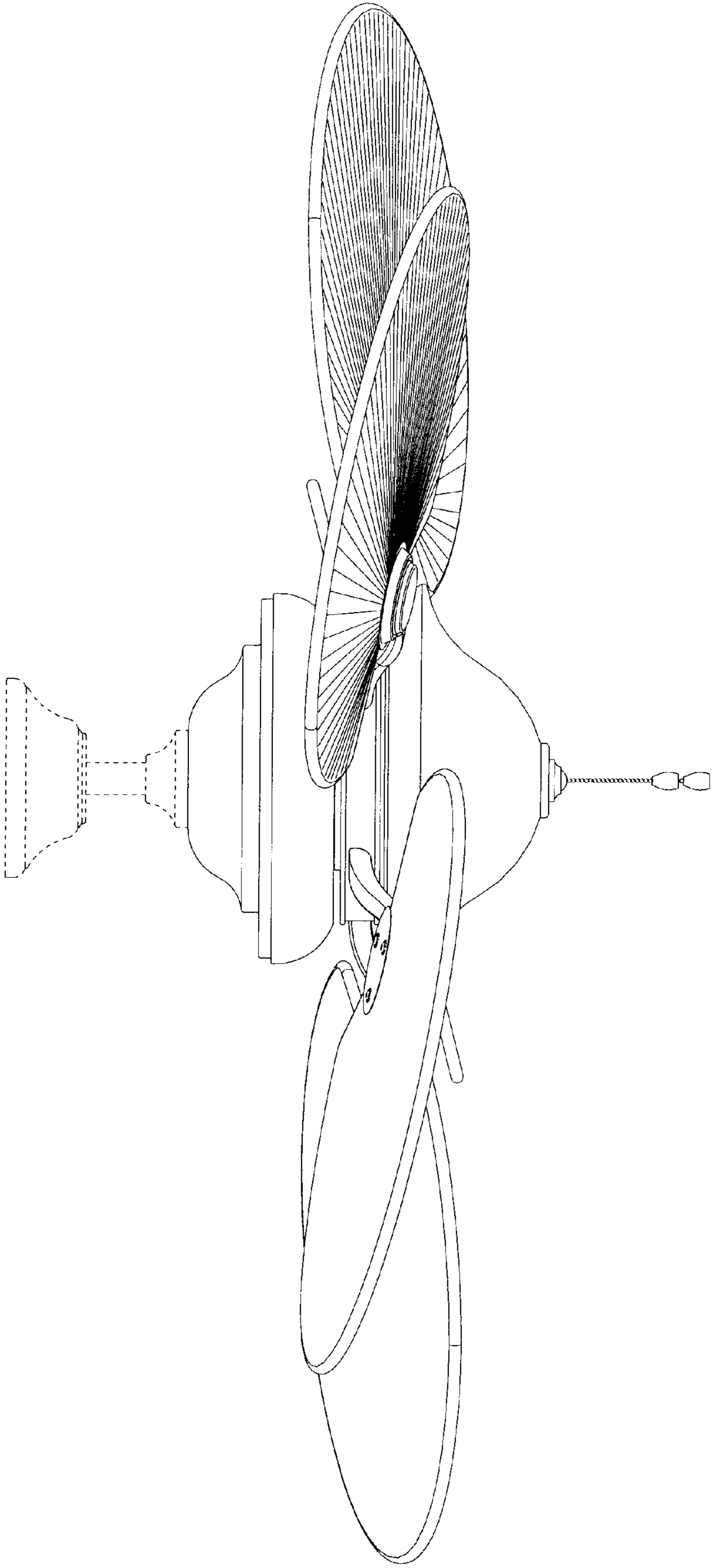

FIG. 5

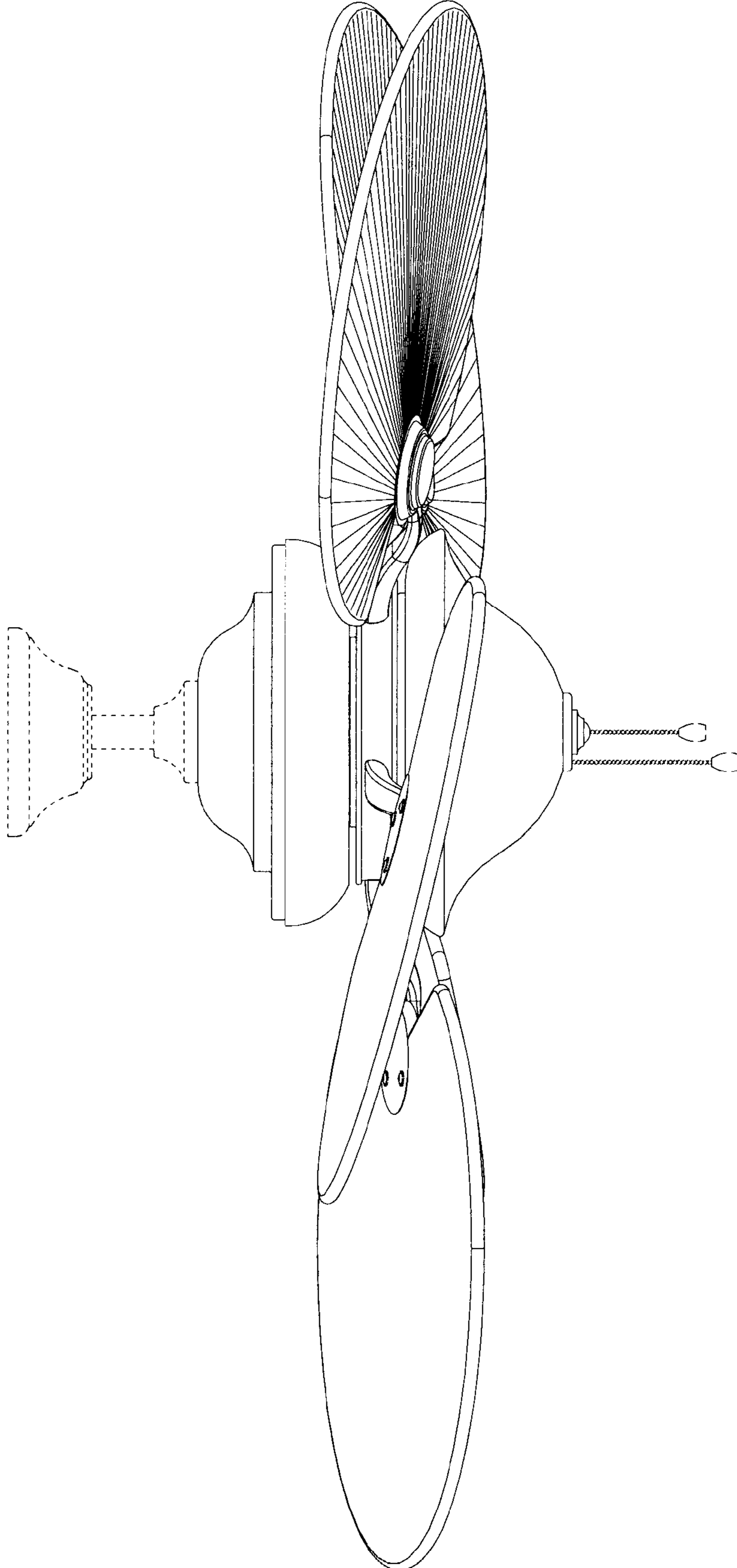

FIG. 6

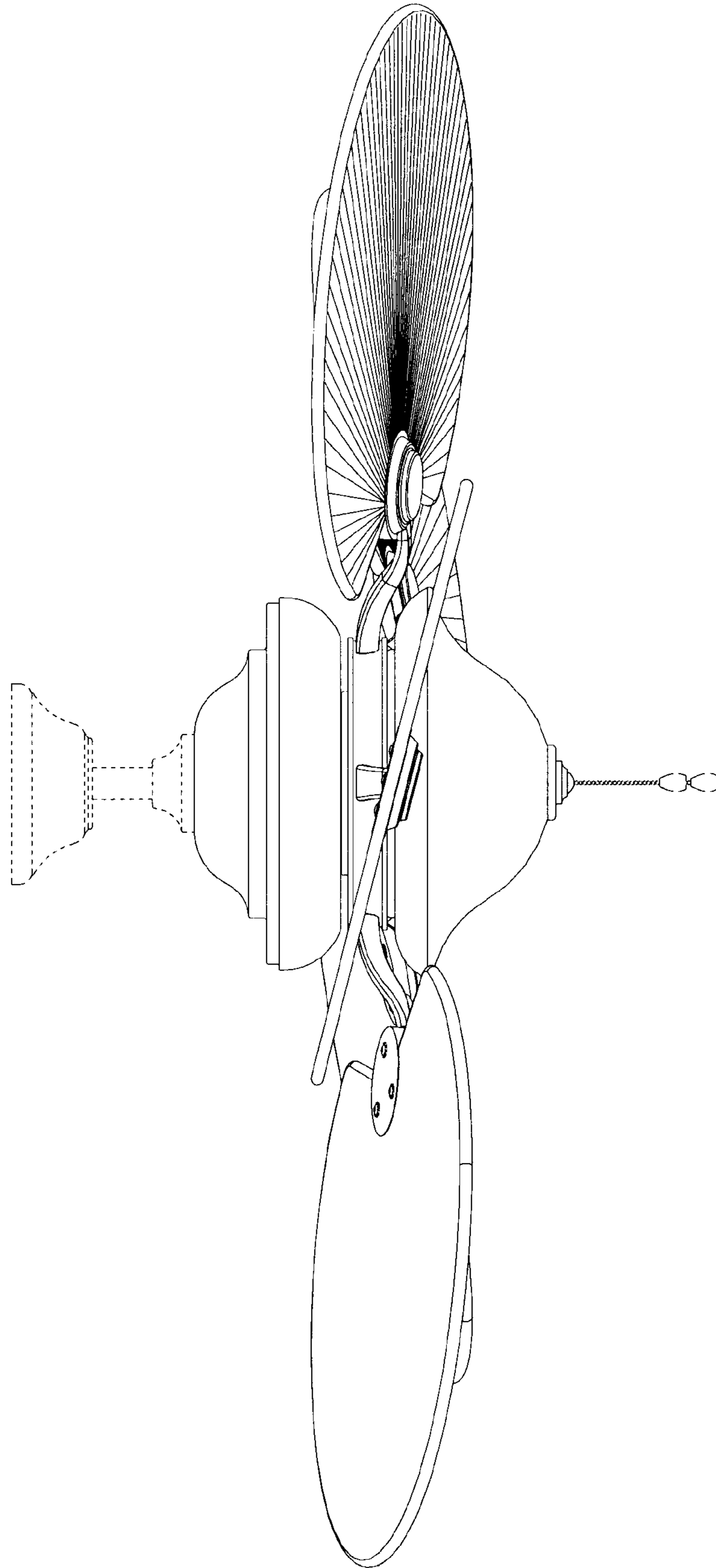
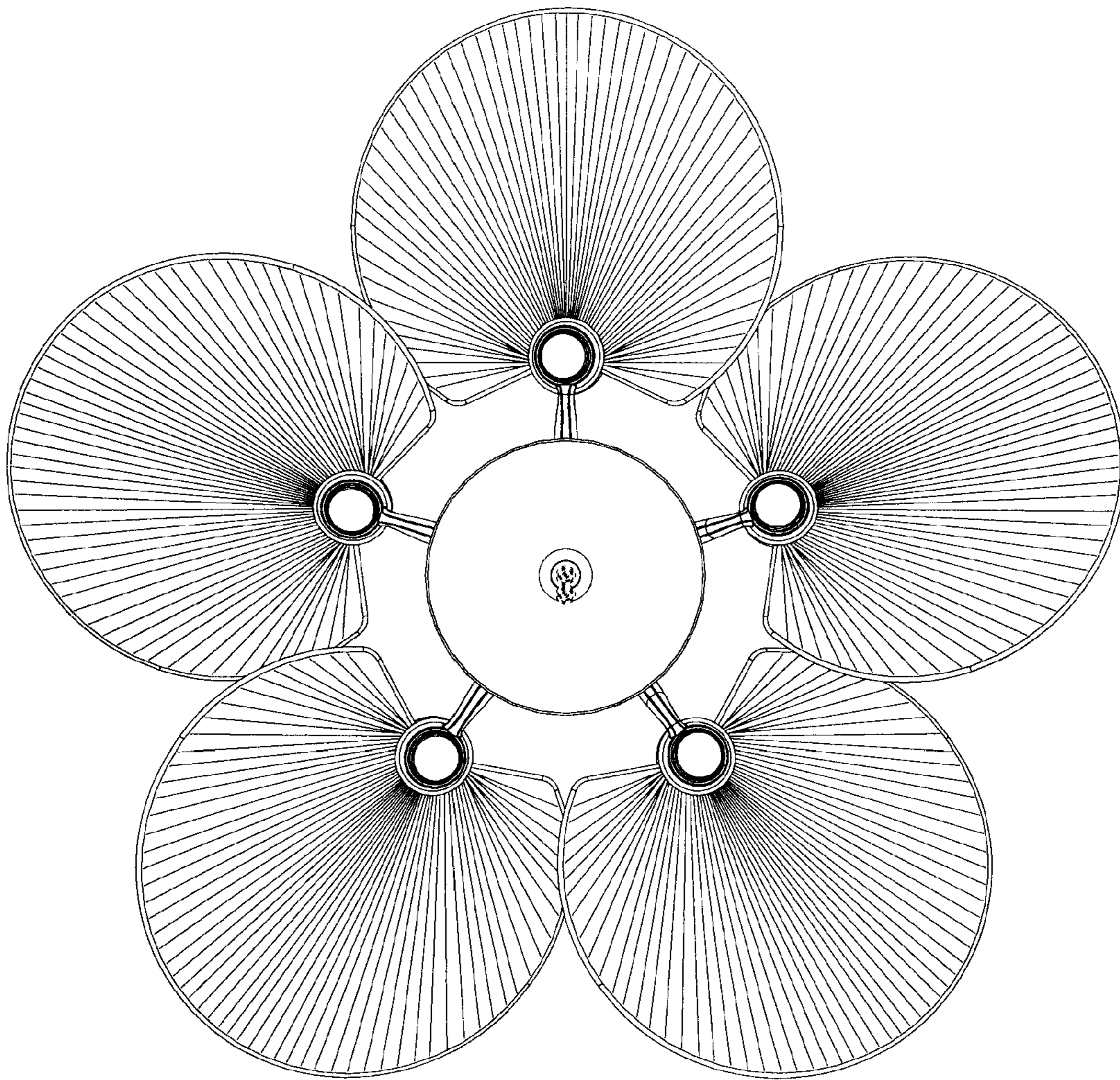

FIG. 7



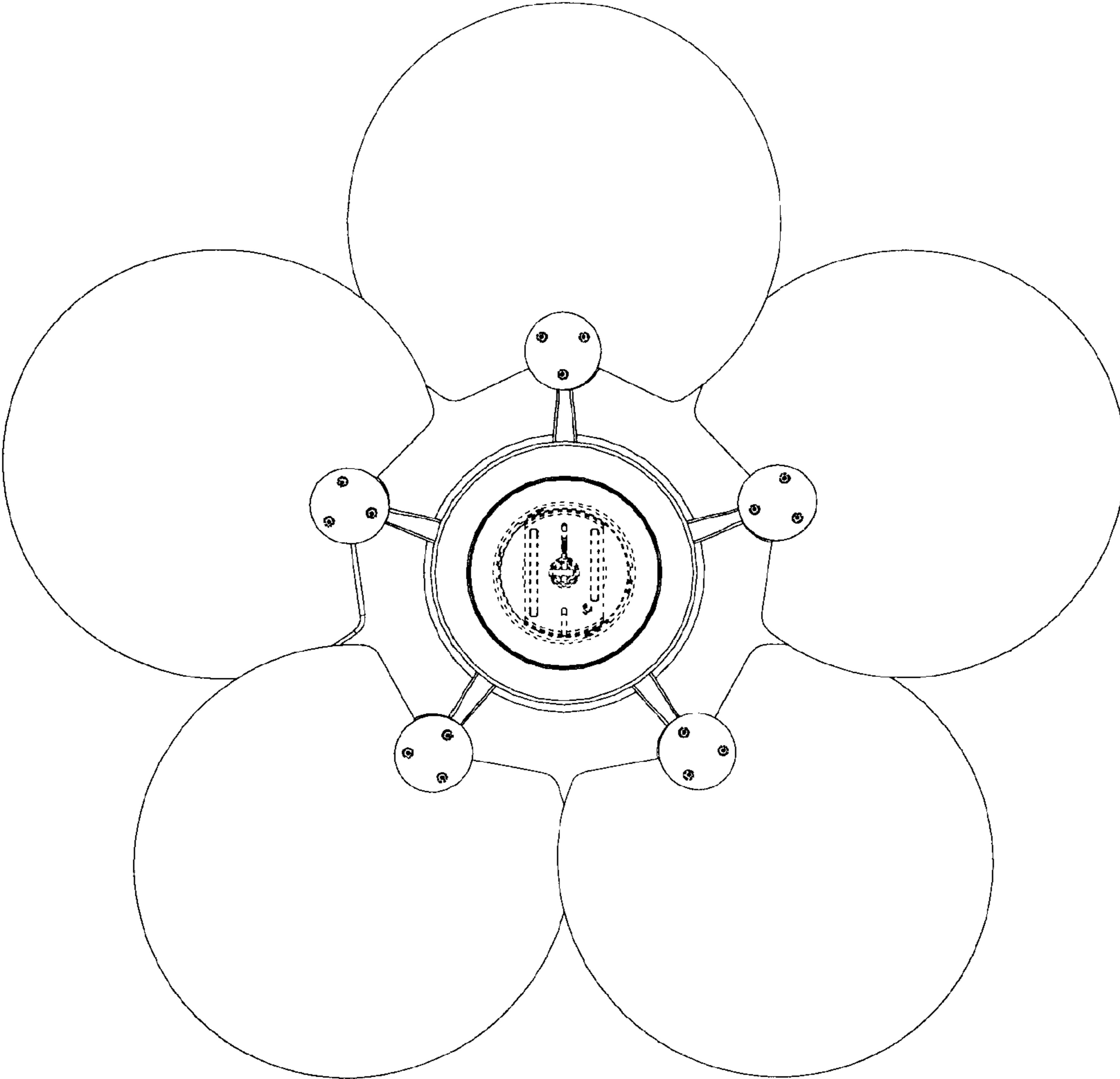

FIG. 8