



US00D597600S

(12) **United States Design Patent**  
**Shimizu**

(10) **Patent No.:** **US D597,600 S**  
(45) **Date of Patent:** **\*\* Aug. 4, 2009**

(54) **BALLPOINT PEN**

(75) Inventor: **Kazuhisa Shimizu**, Tokyo (JP)

(73) Assignee: **Pentel Kabushiki Kaisha** (JP)

(\*\*) Term: **14 Years**

(21) Appl. No.: **29/294,426**

(22) Filed: **Jan. 10, 2008**

(30) **Foreign Application Priority Data**

Jul. 13, 2007 (JP) ..... 2007-019097

(51) **LOC (9) Cl.** ..... **19-06**

(52) **U.S. Cl.** ..... **D19/49**

(58) **Field of Classification Search** ..... D19/35,  
D19/36, 41-51, 53-57; 24/11 R, 11 F, 11 P;  
401/52, 99, 100, 104-109, 192, 195, 196  
See application file for complete search history.

(56) **References Cited**

**U.S. PATENT DOCUMENTS**

D65,683 S \* 9/1924 Benjamin ..... D19/49  
D99,213 S \* 4/1936 Peters ..... D19/49  
D117,839 S \* 11/1939 Zoll ..... D19/49  
D206,917 S \* 2/1967 Jensen ..... D19/49  
D240,032 S \* 5/1976 Gomez ..... D19/49  
D257,857 S \* 1/1981 Leuenberger et al. .... D19/49  
D428,056 S \* 7/2000 Rousseau ..... D19/49

D482,396 S \* 11/2003 De Bon ..... D19/43  
D501,028 S \* 1/2005 Carre ..... D19/43  
D548,280 S \* 8/2007 Shimizu ..... D19/48  
D576,676 S \* 9/2008 Shimizu ..... D19/49

**FOREIGN PATENT DOCUMENTS**

EM 000852488-0001 \* 1/2008

\* cited by examiner

*Primary Examiner*—Elizabeth A Albert

(74) *Attorney, Agent, or Firm*—Adams & Wilks

(57) **CLAIM**

The ornamental design for a ballpoint pen, as shown and described.

**DESCRIPTION**

FIG. 1 is a perspective view of a ballpoint pen showing our new design;

FIG. 2 is a front view thereof;

FIG. 3 is a bottom view thereof, the top view being a mirror image of the bottom view;

FIG. 4 is a rear view thereof;

FIG. 5 is a right side view thereof;

FIG. 6 is a left side view thereof; and,

FIG. 7 is a front view thereof in a state of use, with a front tip being exposed and a cap being fitted to a rear end.

**1 Claim, 4 Drawing Sheets**

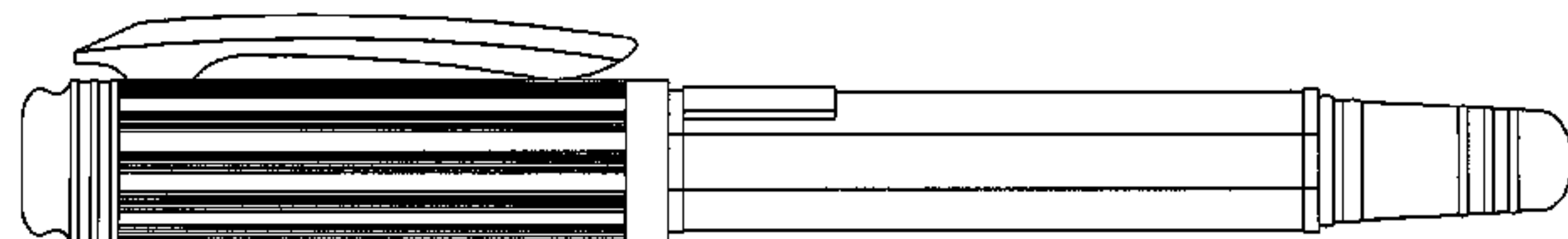
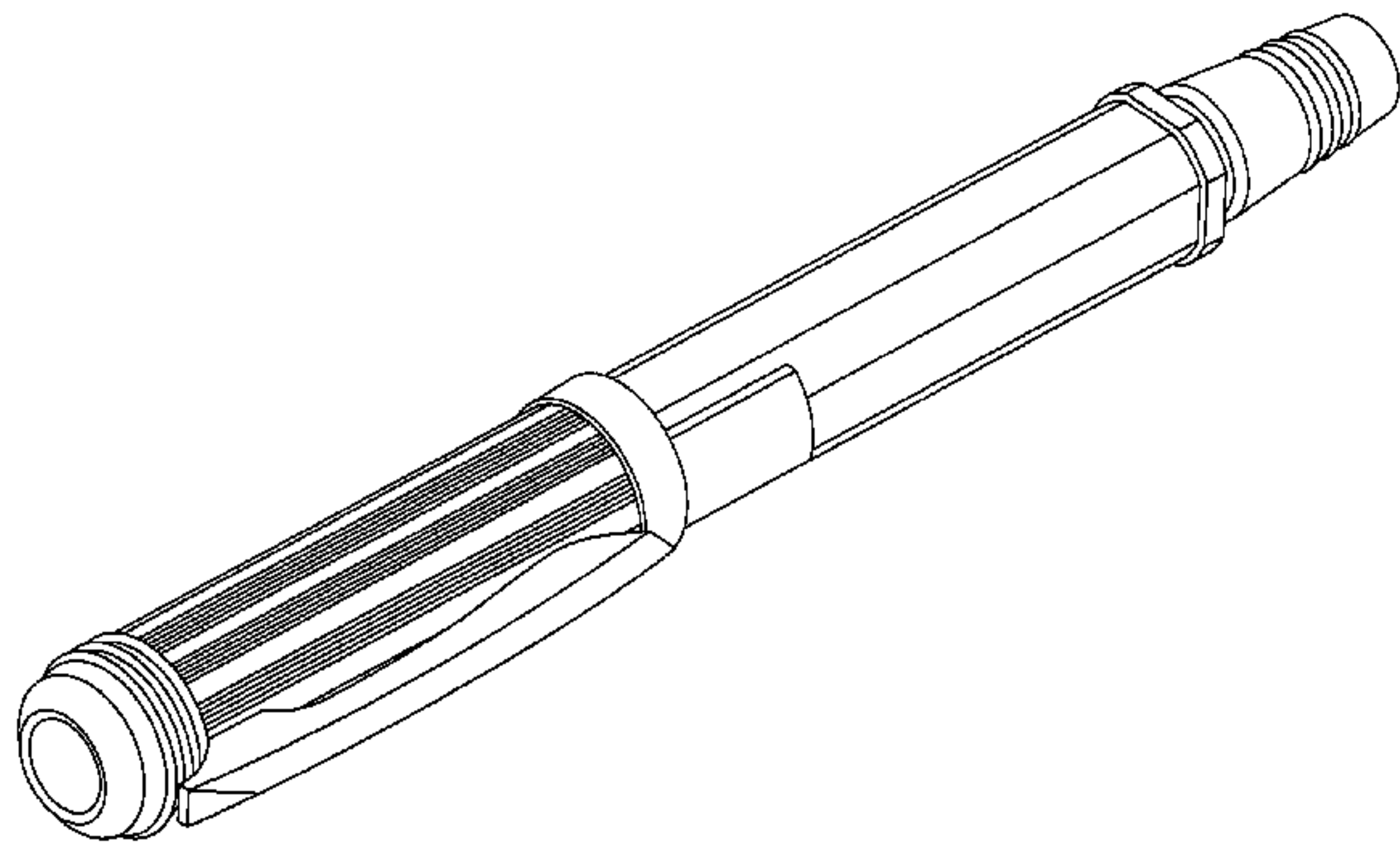

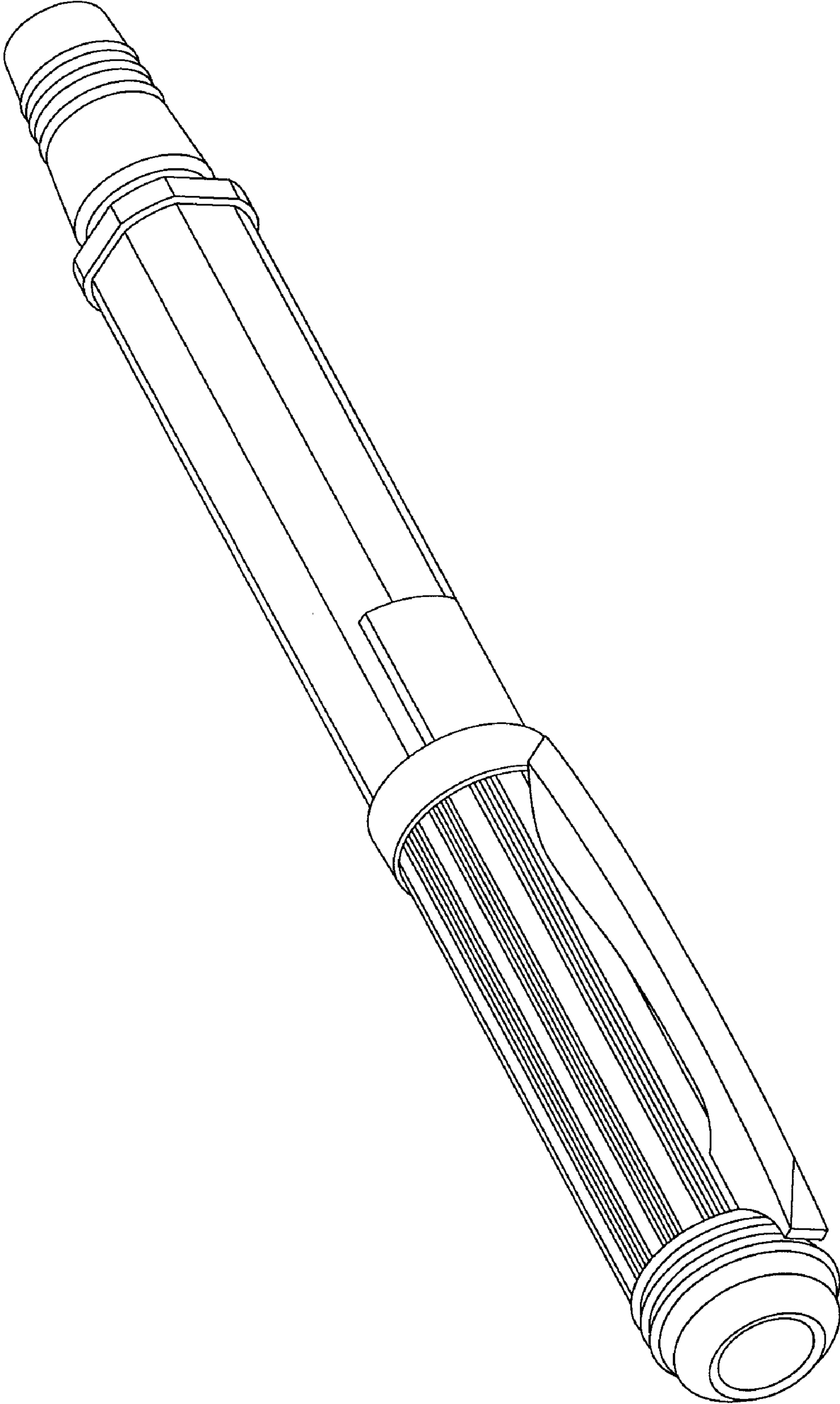

FIG. 1

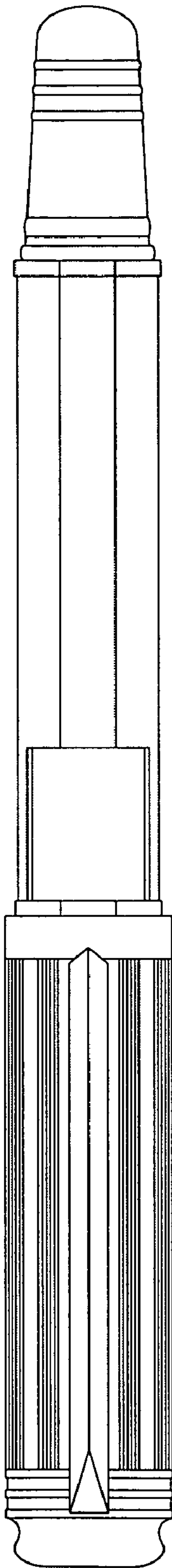

FIG. 2

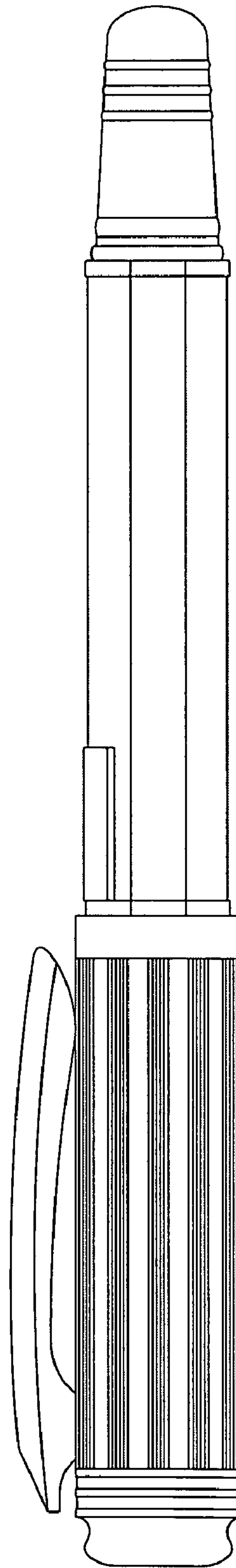

FIG. 3

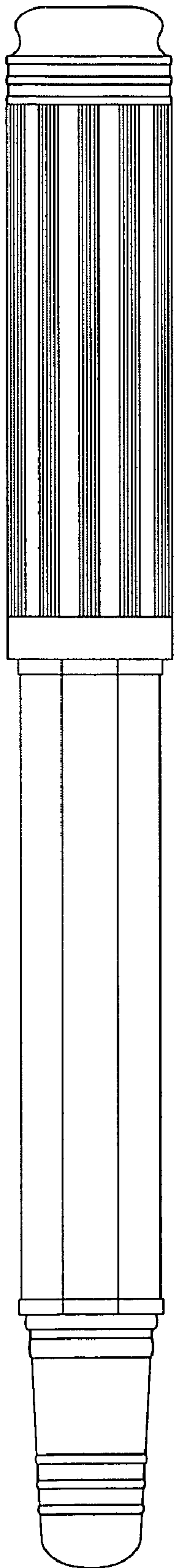

FIG. 4

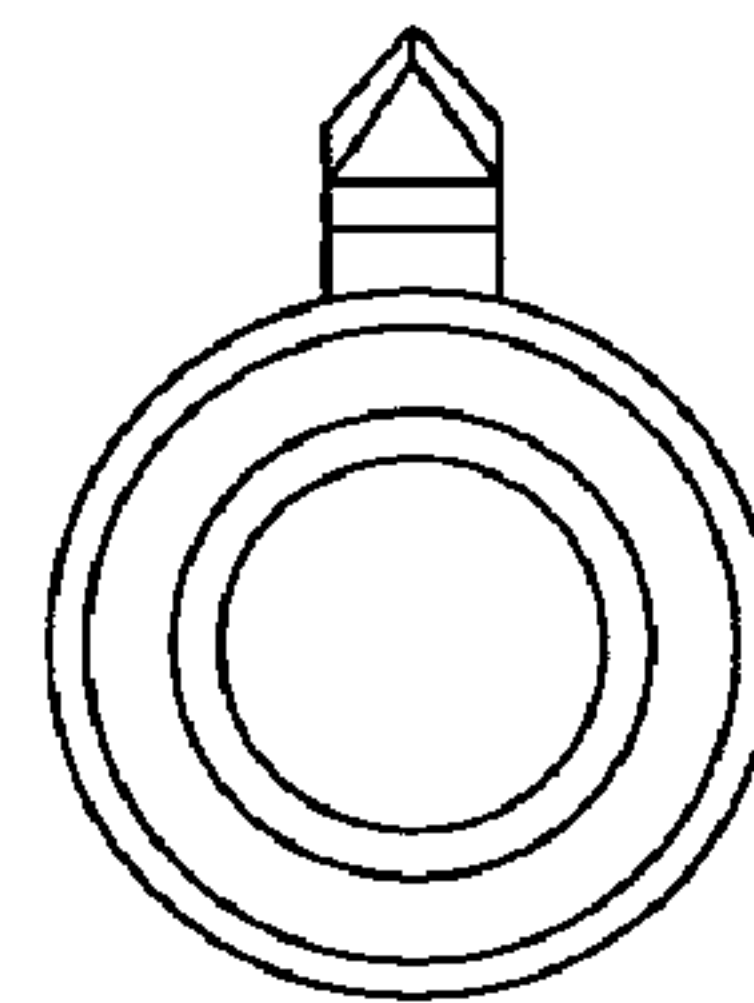

FIG. 6

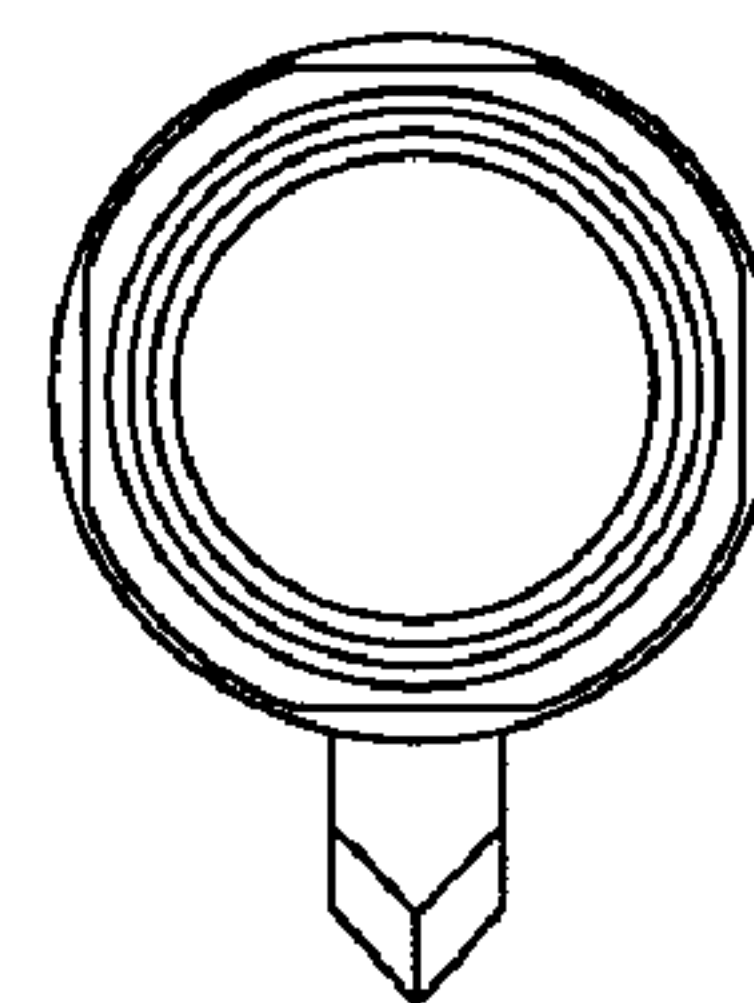

FIG. 5

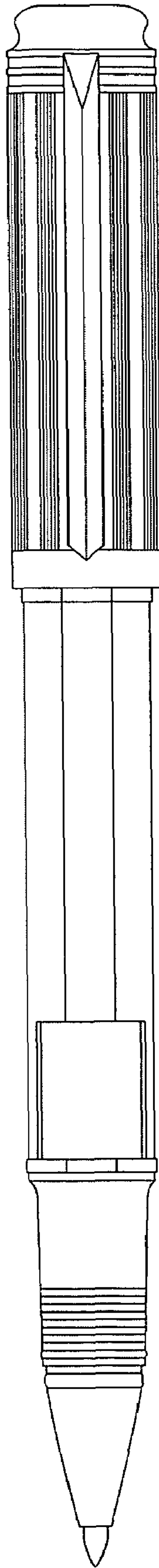

FIG. 7