

US00D597393S

(12) **United States Design Patent**  
**Klippel et al.**

(10) **Patent No.:** **US D597,393 S**

(45) **Date of Patent:** **\*\* Aug. 4, 2009**

(54) **CLAMP HEAD**

(75) Inventors: **Simon Francis Klippel**, Knaresborough (GB); **Neil Frank Gill**, Shipley (GB); **Mark Gaskell**, Bradford (GB); **Louise Caroline Foster**, Castleford (GB)

(73) Assignee: **EV IP LP**, Dover, DE (US)

(\*\*) Term: **14 Years**

(21) Appl. No.: **29/306,121**

(22) Filed: **Apr. 2, 2008**

**Related U.S. Application Data**

(63) Continuation of application No. 12/014,738, filed on Jan. 15, 2008, now abandoned.

(30) **Foreign Application Priority Data**

Jan. 16, 2007 (GB) ..... 0700818.8  
Oct. 3, 2007 (EM) ..... 000803390-0001

(51) **LOC (9) Cl.** ..... **09-05**

(52) **U.S. Cl.** ..... **D8/72**

(58) **Field of Classification Search** ..... D8/71-74, D8/394-397, 354, 355, 356, 399; 248/72, 248/62, 689, 124.2, 313; 81/10, 118, 132, 81/155-164, 173, 175; 269/3, 6, 143, 165, 269/240-253, 43, 140; 29/256, 257, 276; D15/140

See application file for complete search history.

(56) **References Cited**

**U.S. PATENT DOCUMENTS**

3,228,640 A \* 1/1966 Walsh ..... 248/72

4,570,885 A *	2/1986	Heath	.....	248/72
D370,624 S *	6/1996	DiBiagio	.....	D8/394
5,586,373 A *	12/1996	Eby et al.	.....	269/249
D389,051 S *	1/1998	Caveney et al.	.....	D8/396
D401,968 S *	12/1998	Suzuki	.....	D8/395
D429,625 S *	8/2000	Sikkila et al.	.....	D8/354
D505,617 S *	5/2005	Eason	.....	D8/396
7,179,010 B2 *	2/2007	Weger et al.	.....	248/72
D545,184 S *	6/2007	Hanamura	.....	D8/397
D556,531 S *	12/2007	Allen	.....	D8/72
D575,088 S *	8/2008	Saulnier	.....	D8/394
D580,262 S *	11/2008	Eason et al.	.....	D8/396

\* cited by examiner

*Primary Examiner*—T. Chase Nelson

*Assistant Examiner*—David G Muller

(74) *Attorney, Agent, or Firm*—Proskauer Rose LLP

(57) **CLAIM**

The ornamental design for a clamp head, as shown and described.

**DESCRIPTION**

FIG. 1 is a top perspective view of a clamp head.

FIG. 2 is a bottom perspective view of the clamp head of FIG. 1.

FIG. 3 is a front-end plan view of the clamp head of FIG. 1.

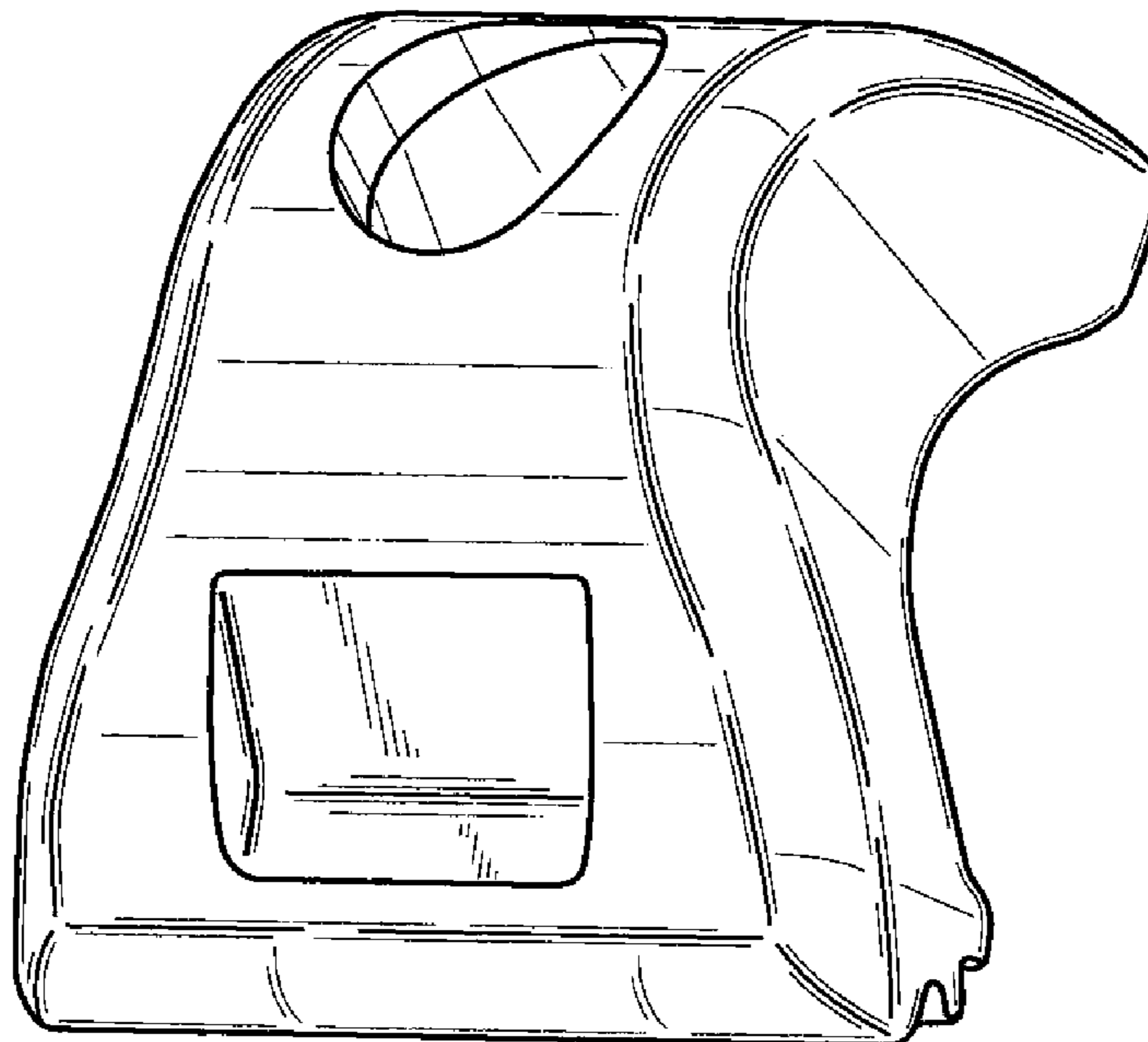
FIG. 4 is a right-side plan view of the clamp head of FIG. 1. The left-side plan view is a mirror image of the right-side plan view.

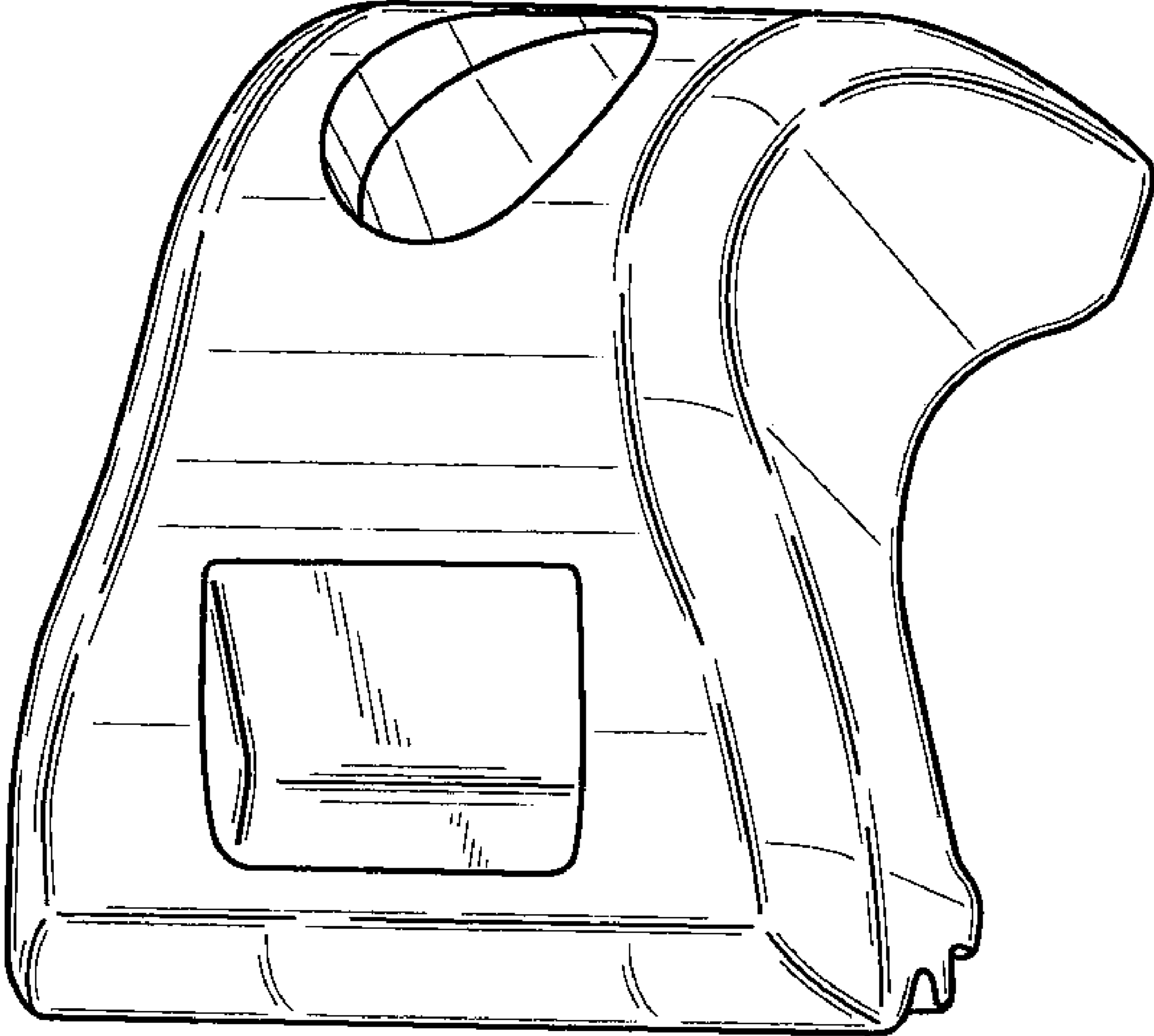
FIG. 5 is a rear-end plan view of the clamp head of FIG. 1.

FIG. 6 is a top plan view of the clamp head of FIG. 1; and,

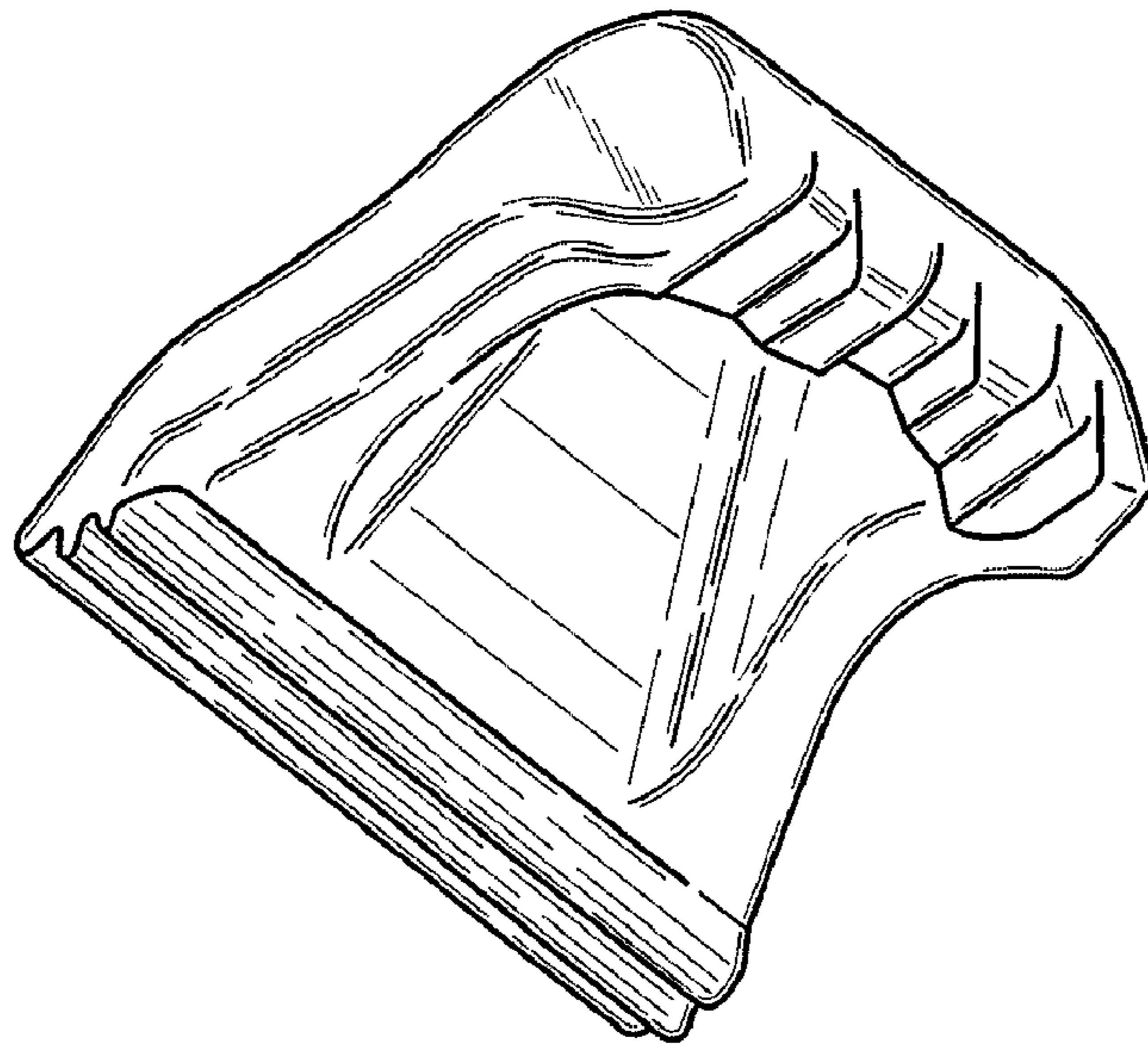
FIG. 7 is a bottom plan view of the clamp head of FIG. 1.

**1 Claim, 4 Drawing Sheets**

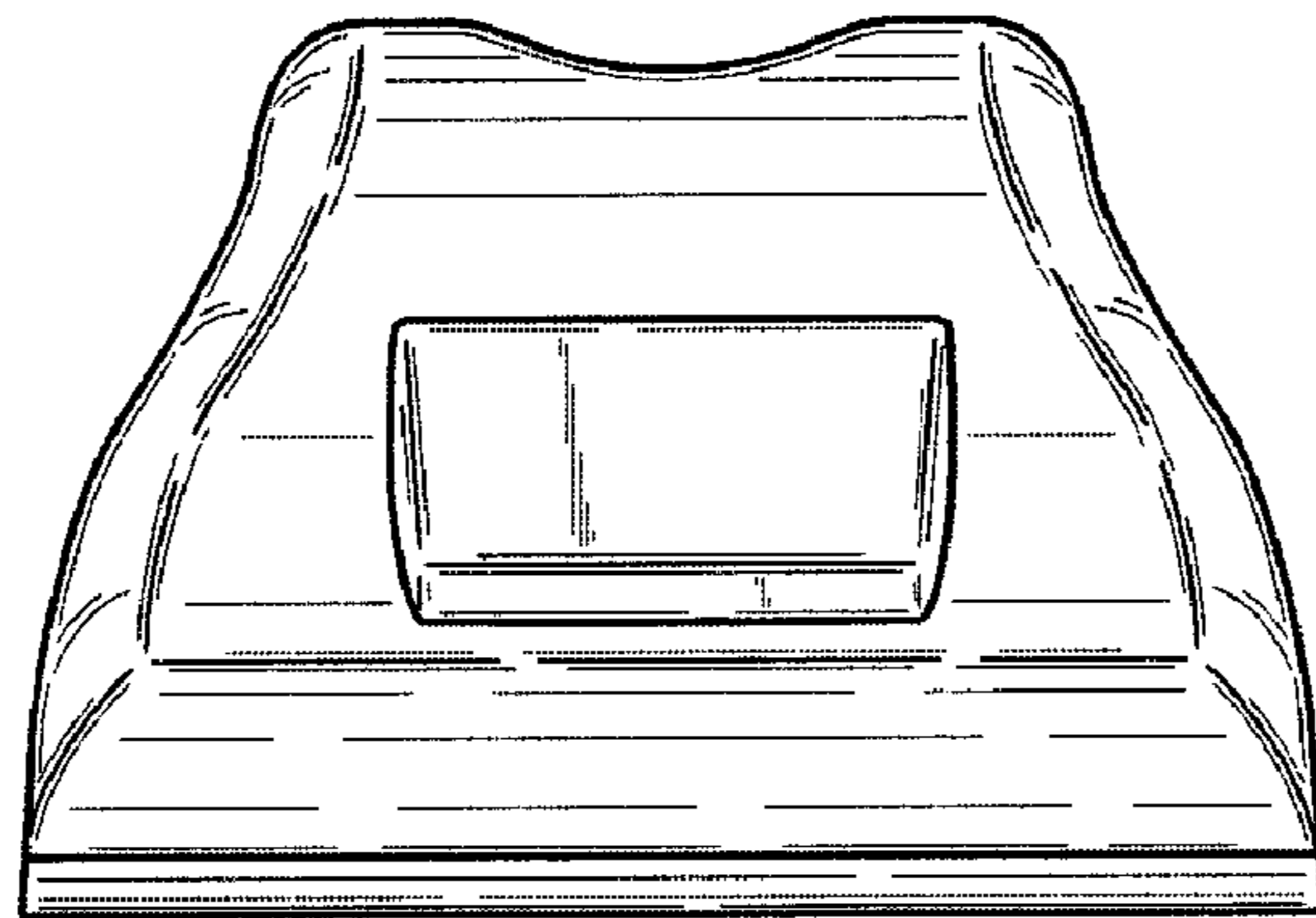




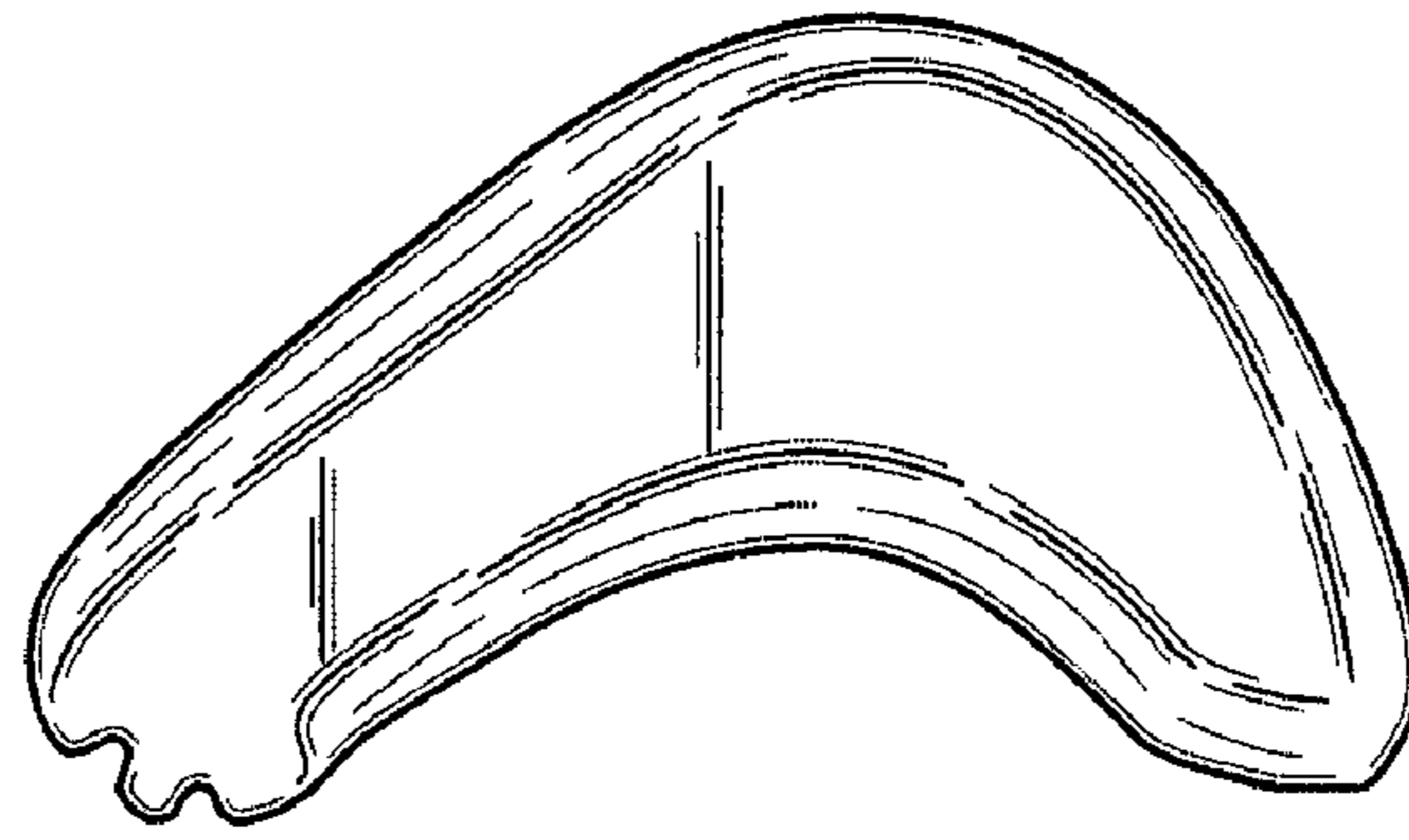
**Fig. 1**



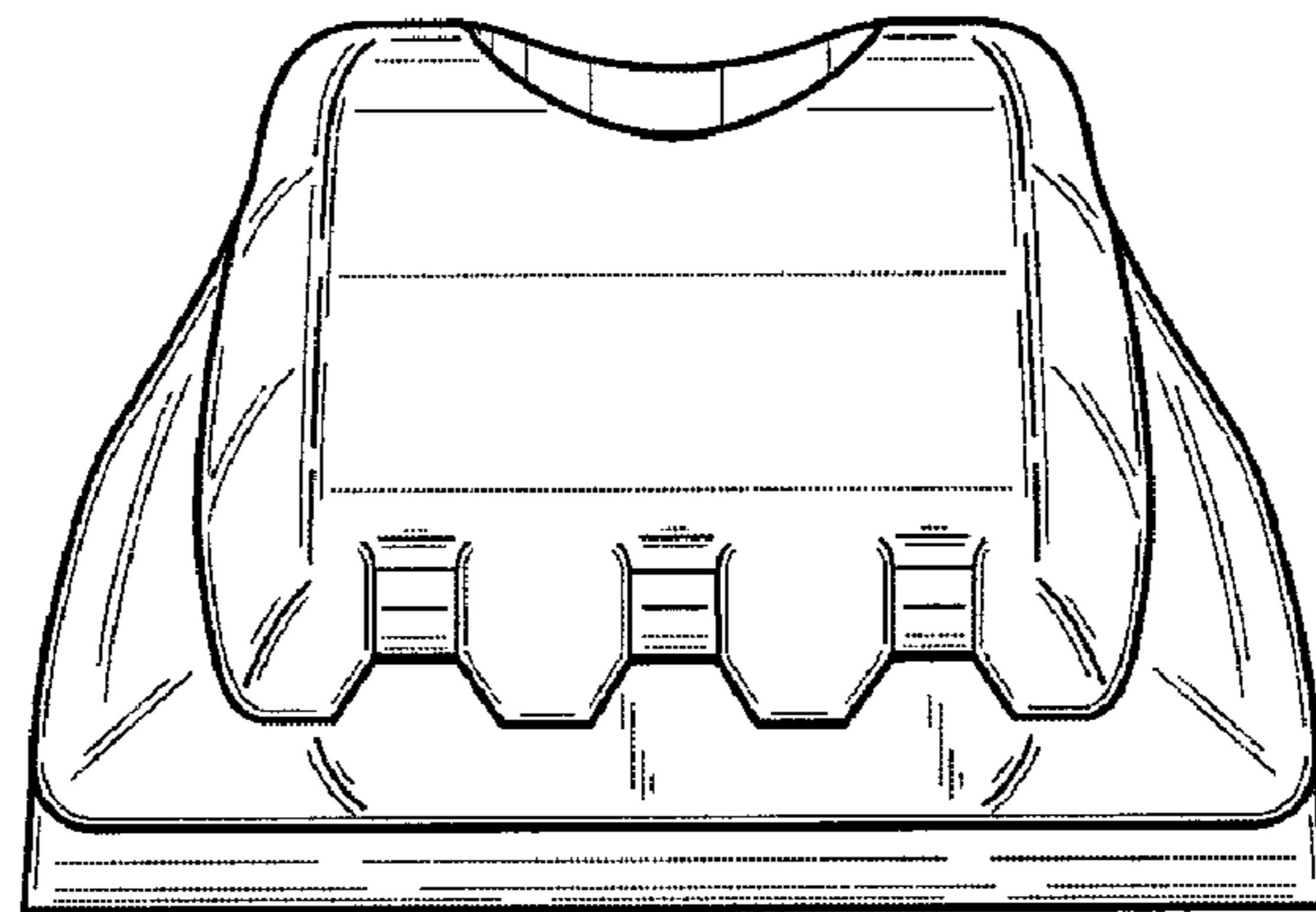
**Fig. 2**



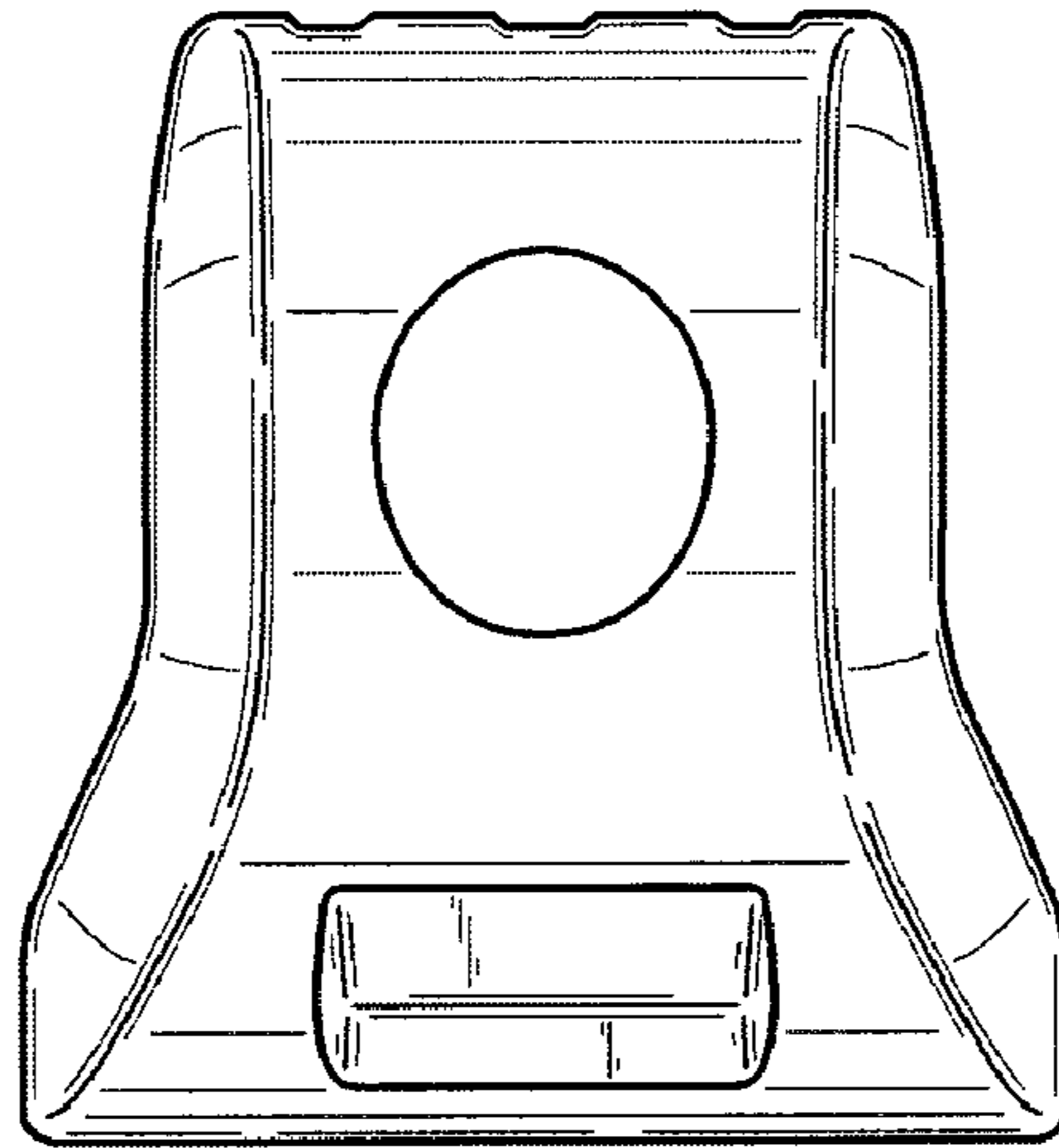
**Fig. 3**



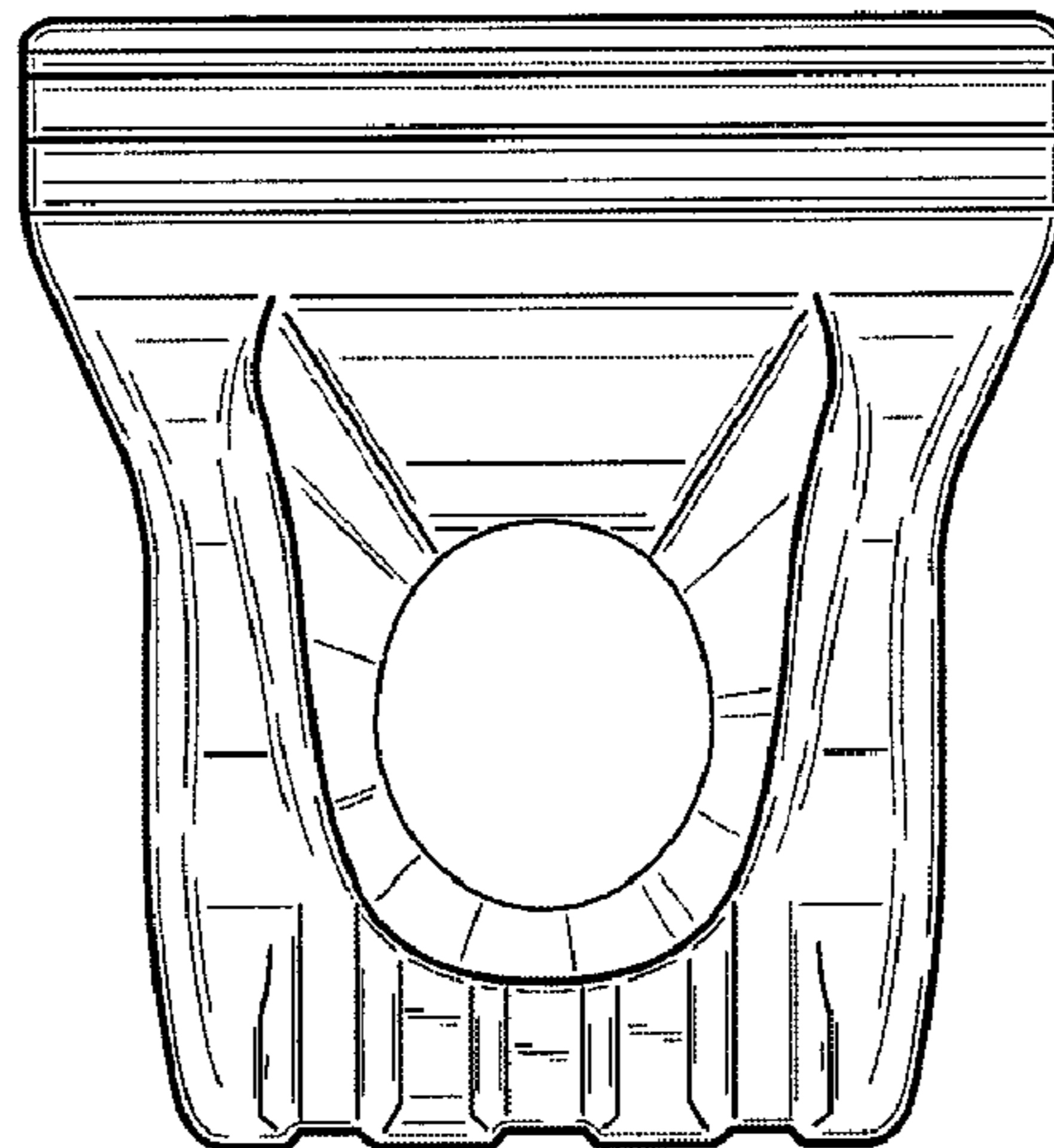
**Fig. 4**



**Fig. 5**



**Fig. 6**



**Fig. 7**