



US00D597354S

(12) **United States Design Patent**
Liss

(10) **Patent No.:** **US D597,354 S**

(45) **Date of Patent:** **** Aug. 4, 2009**

(54) **PORTION OF A WIRE RACK SHELF UNIT**

(75) Inventor: **Mitchell Liss**, Northbrook, IL (US)

(73) Assignee: **Edsal Manufacturing Co., Inc.**,
Chicago, IL (US)

(**) Term: **14 Years**

(21) Appl. No.: **29/318,168**

(22) Filed: **May 15, 2008**

(51) **LOC (9) Cl.** **06-04**

(52) **U.S. Cl.** **D6/511**

(58) **Field of Classification Search** D6/396,
D6/397, 630, 449, 465, 474, 499, 476-479,
D6/511; 108/59-61, 91-93, 147.11, 158.11;
211/49.1, 85.26, 133.2, 134, 181.1, 182,
211/188, 203, 59.2, 153; D8/354

See application file for complete search history.

(56) **References Cited**

U.S. PATENT DOCUMENTS

D215,773	S	*	10/1969	Maslow	D6/462
D289,479	S	*	4/1987	Brancher	D6/511
D291,165	S	*	8/1987	Ray	D6/465
D292,658	S	*	11/1987	Kester	D6/465
D292,764	S	*	11/1987	Kester	D6/465
D308,776	S	*	6/1990	Yau Kee	D6/464
D314,103	S	*	1/1991	Yau Kee	D6/465
D323,256	S	*	1/1992	Kee	D6/465
D326,579	S	*	6/1992	Leeds	D6/511
D328,400	S	*	8/1992	Kee	D6/465
D374,601	S	*	10/1996	Olson	D7/354
D385,444	S	*	10/1997	Welch et al.	D6/511
5,676,263	A	*	10/1997	Chang	211/187
5,779,070	A	*	7/1998	Dickinson et al.	211/187
D424,836	S	*	5/2000	Kopala, Jr.	D6/465
D429,092	S	*	8/2000	Walter	D6/465
D432,820	S	*	10/2000	Walters-Dowding et al.	D6/465
6,422,406	B1	*	7/2002	Kessel et al.	211/181.1
D471,033	S	*	3/2003	Yamaguchi	D6/465
D471,381	S	*	3/2003	Yamaguchi	D6/465
D485,092	S	*	1/2004	Rosen	D6/465

D562,590	S	*	2/2008	Colin et al.	D6/462
2004/0099619	A1	*	5/2004	Bustos	211/59.2
2008/0302746	A1	*	12/2008	Scholz	211/153
2008/0308516	A1	*	12/2008	Li	211/153

* cited by examiner

Primary Examiner—Janice E Seeger

Assistant Examiner—Sydney R Buffalow

(74) *Attorney, Agent, or Firm*—Wood, Herron & Evans, LLP

(57) **CLAIM**

The ornamental design for a portion of a wire rack shelf unit, as shown and described.

DESCRIPTION

FIG. 1 is an isometric view of the design in a shelving unit with the broken lines showing environment, in which the design in solid lines is embodied;

FIG. 2 is an enlarged perspective view of a portion of the solid line portion design of FIG. 1;

FIG. 3 is a front view of the design of FIG. 2;

FIG. 4 is a right side view of the design of FIG. 2;

FIG. 5 is a top plan view of the design of FIGS. 1 and 2;

FIG. 6 is a bottom view of the design of FIGS. 1 and 2;

FIG. 7 is a cross-sectional view taken along lines 7—7 of FIG. 5;

FIG. 8 is a cross-sectional view taken along lines 8—8 of FIG. 5; and,

FIGS. 9—16 illustrate an alternative embodiment of the design of FIGS. 1—8 and are the same as the design shown in the respectively corresponding FIGS. 1—8 with the sole exception of the omission of the keyhole-shaped apertures and trailing end rivets or studs therein which are shown in FIGS. 1—8.

The segment lines on the ends of the vertical solid line portions of FIGS. 1—4, 7 and 8 indicate indefinite extension of those portions of the design and are not themselves part of the design.

1 Claim, 12 Drawing Sheets

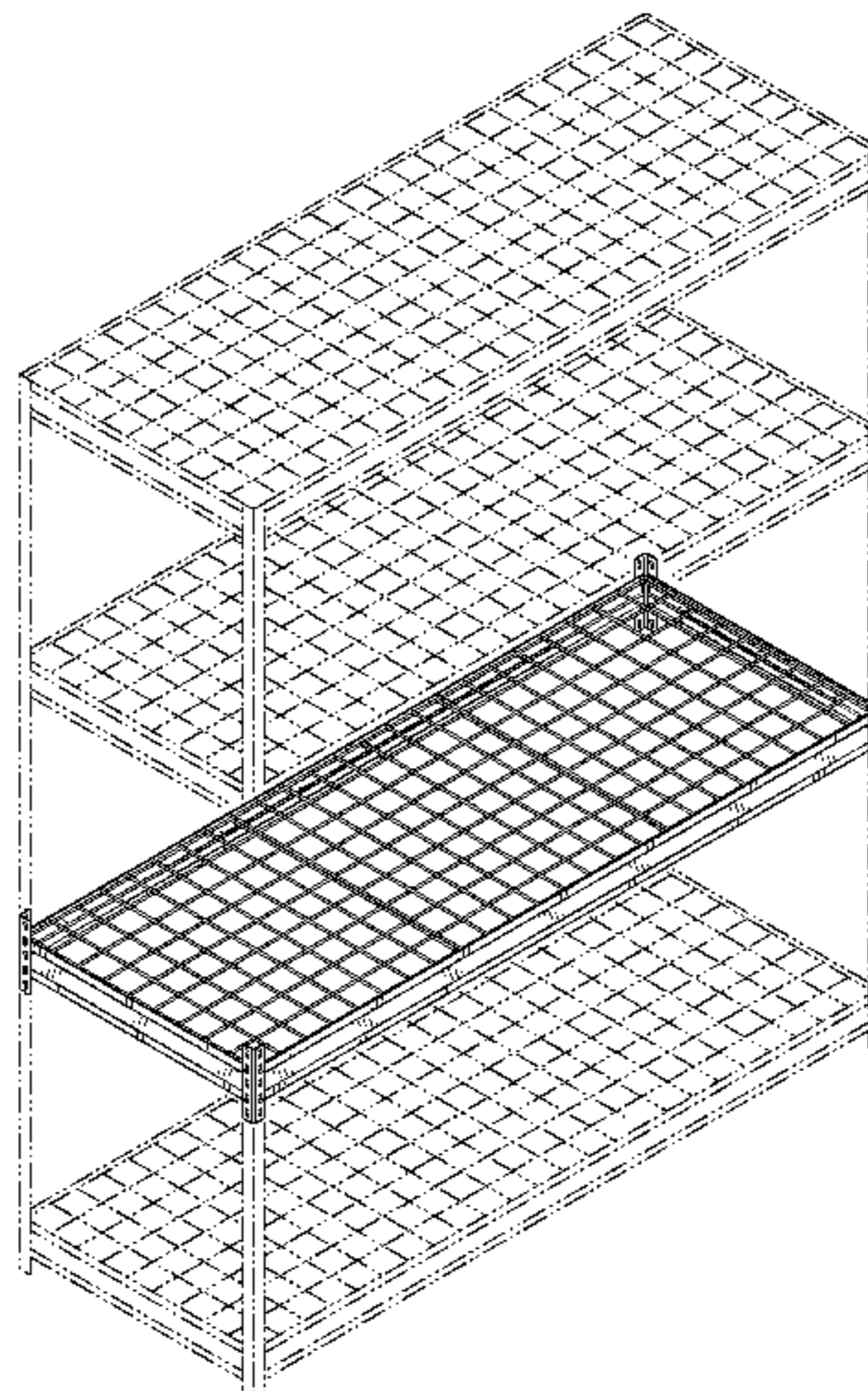

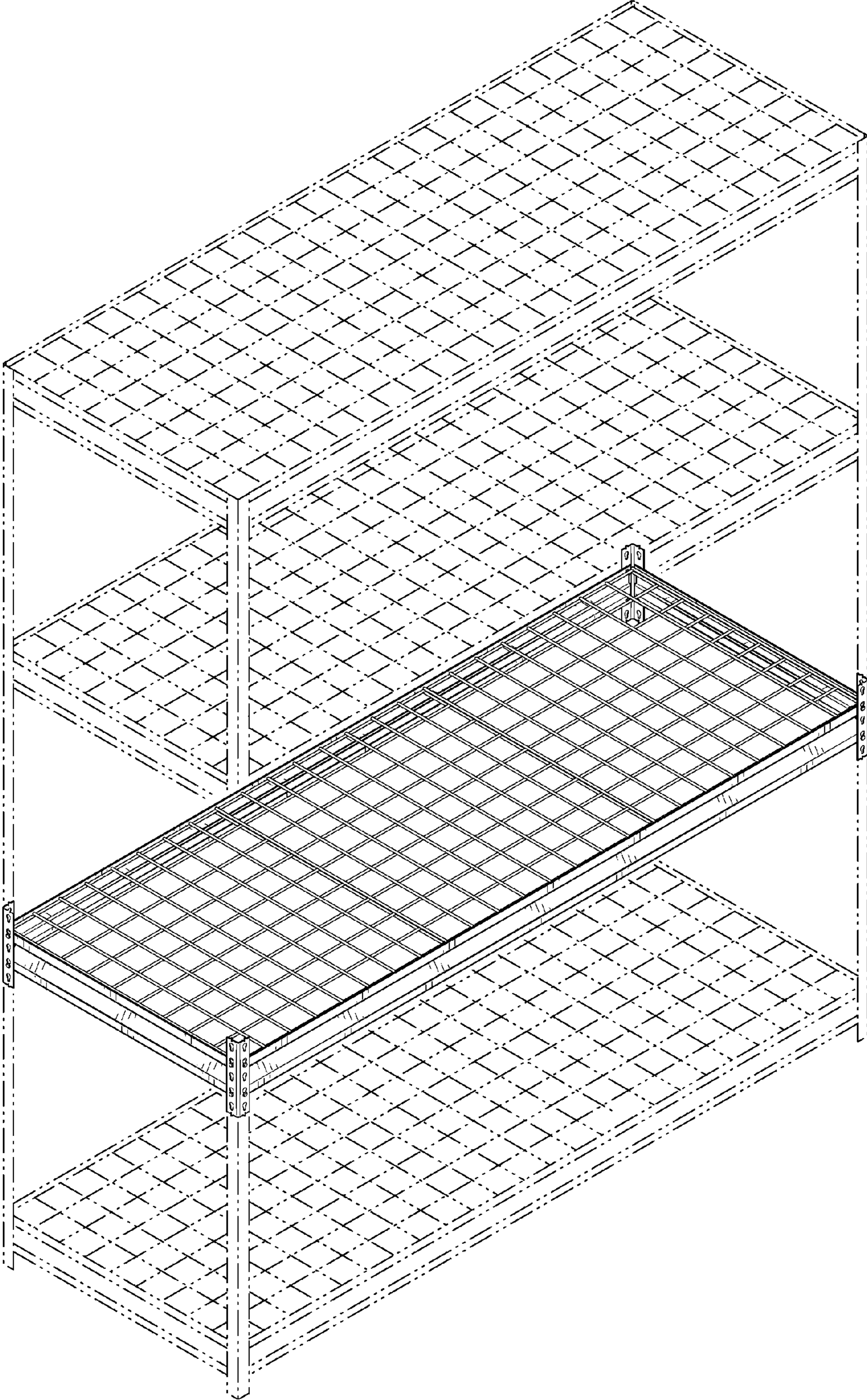

FIG. 1

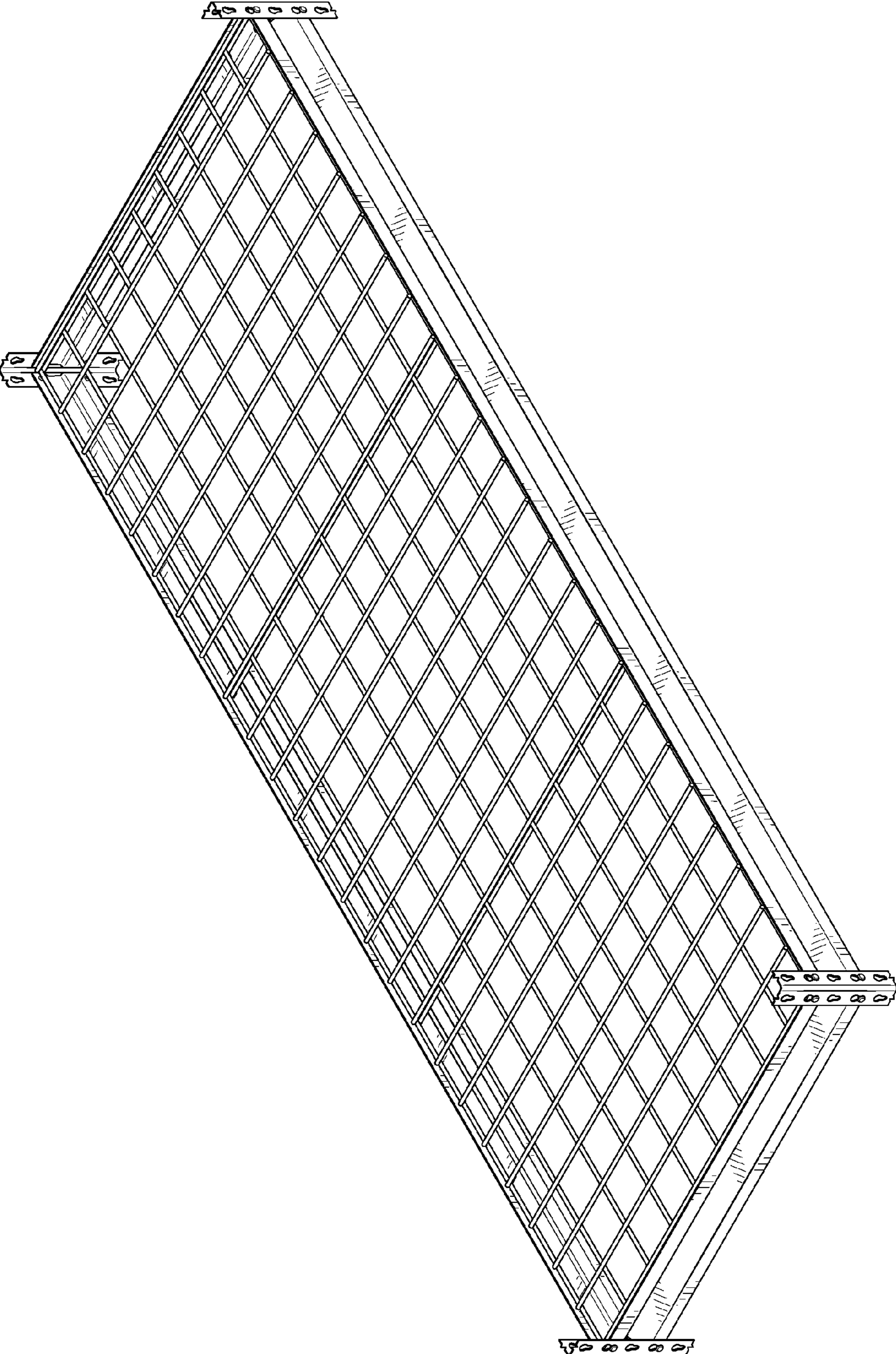

FIG. 2

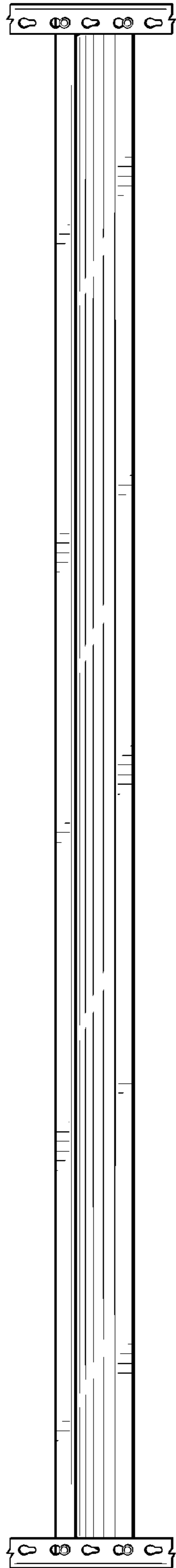

FIG. 3

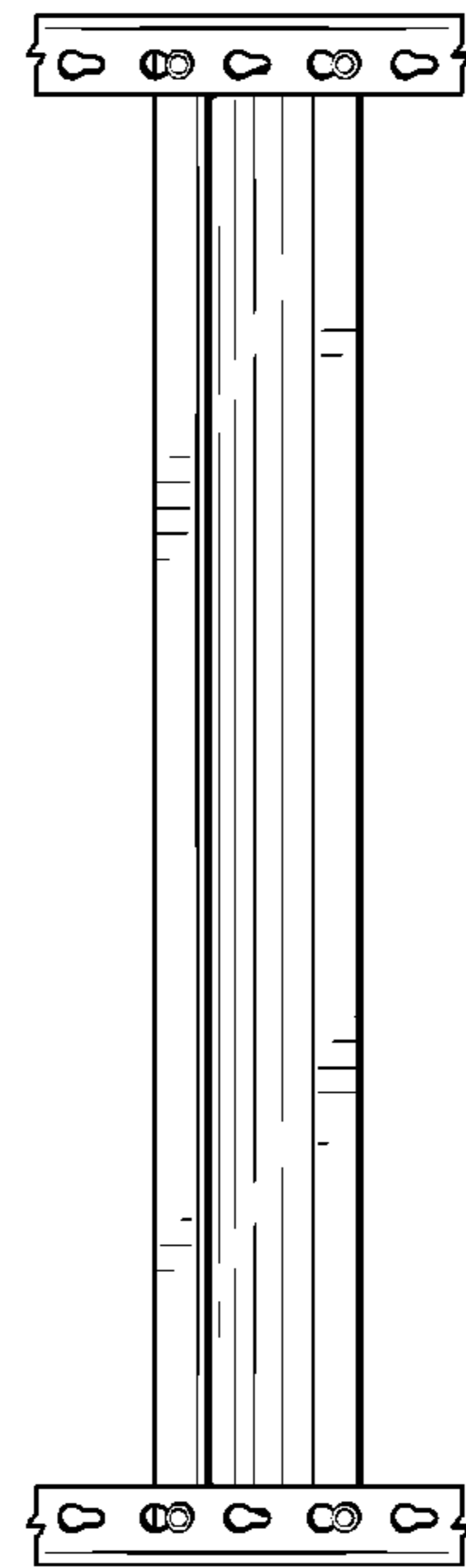

FIG. 4

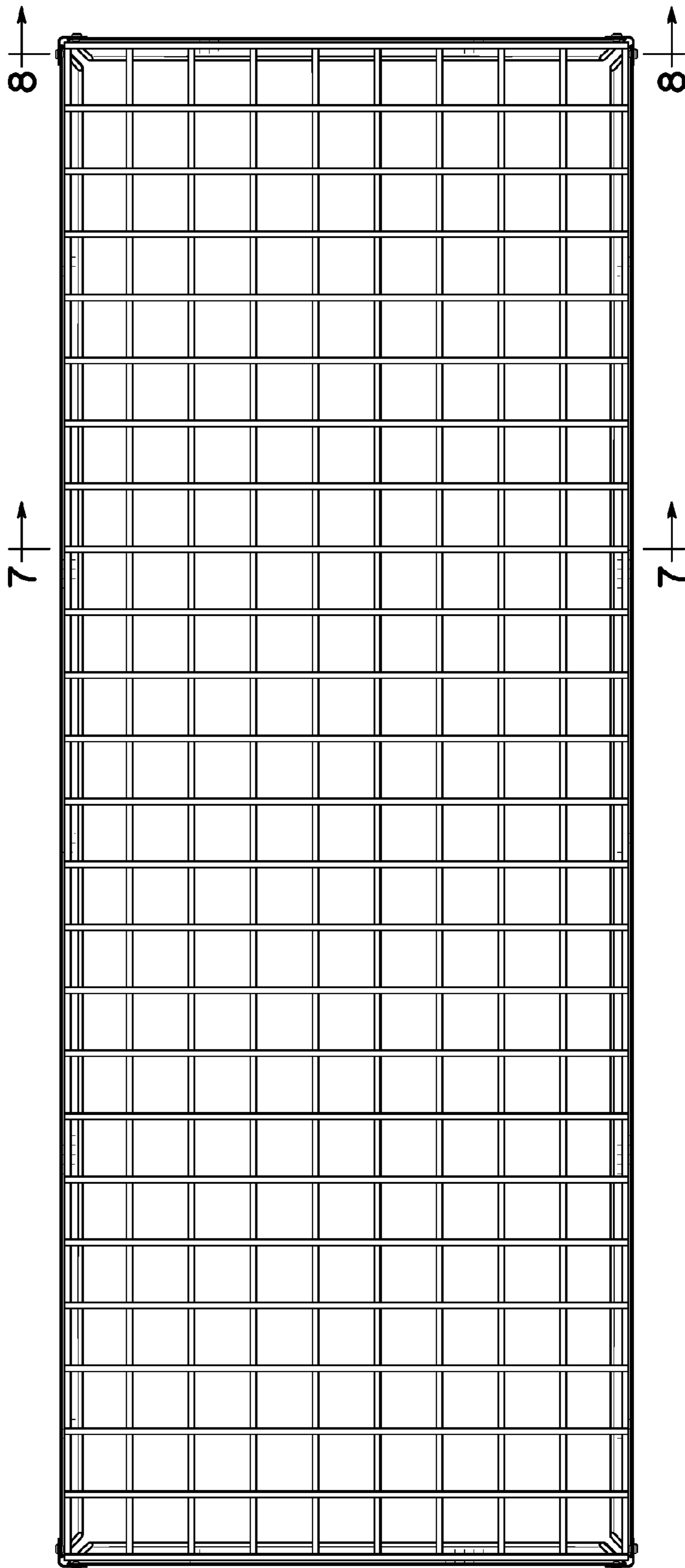

FIG. 5

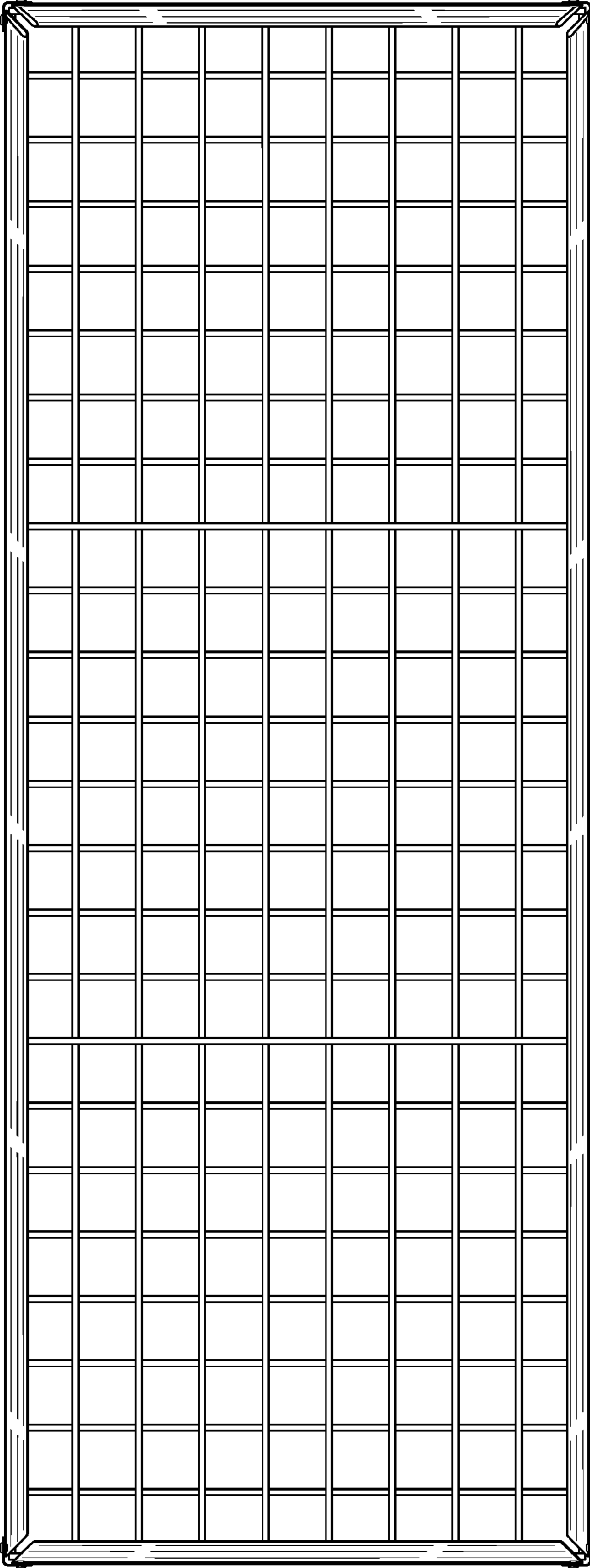

FIG. 6

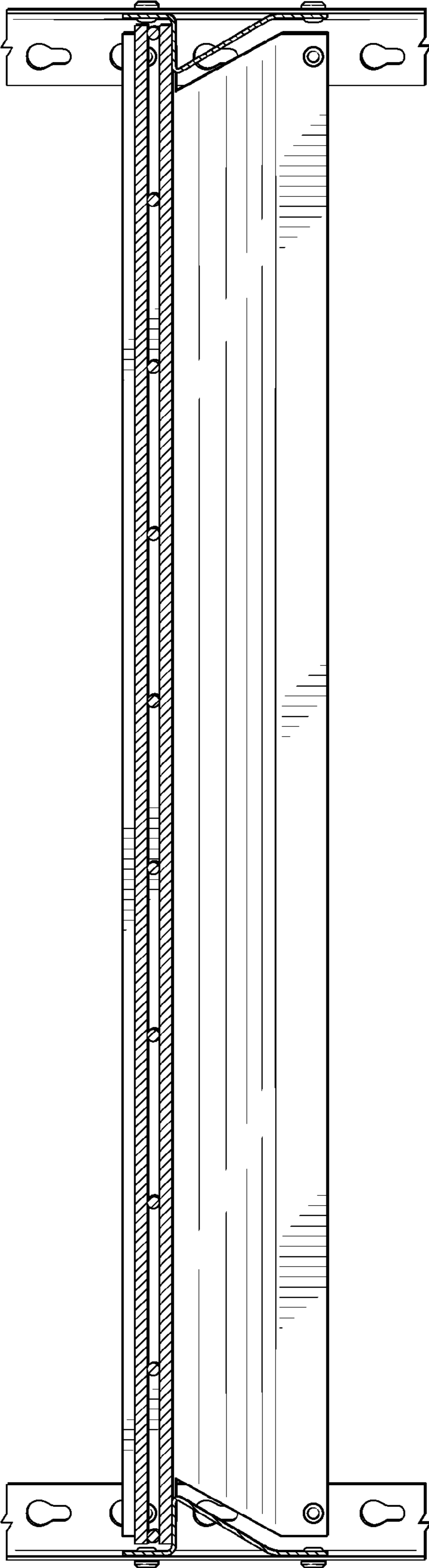

FIG. 7

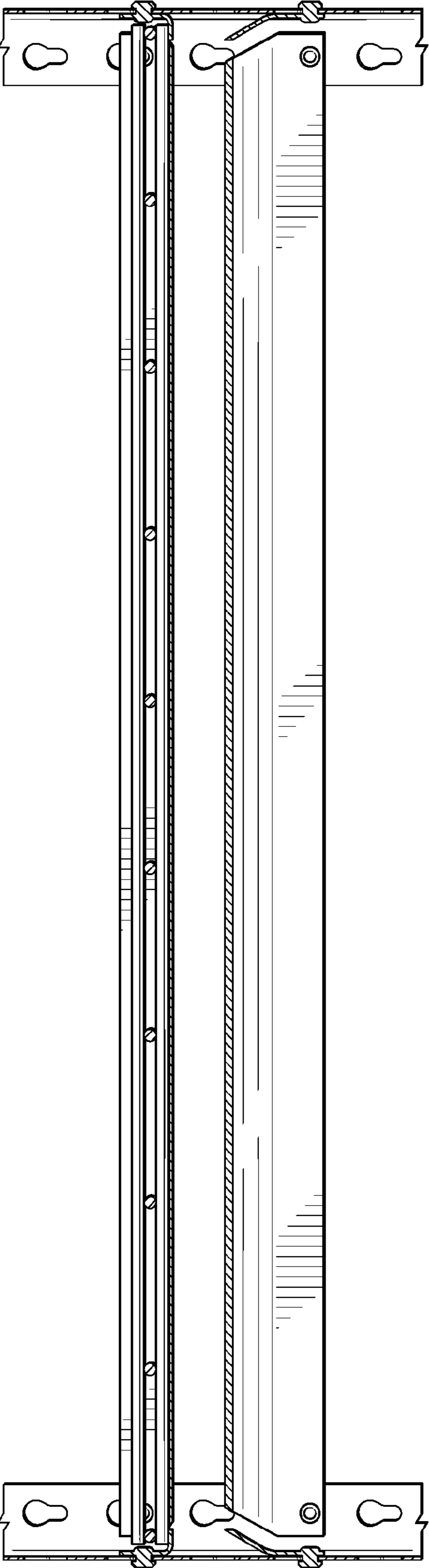

FIG. 8

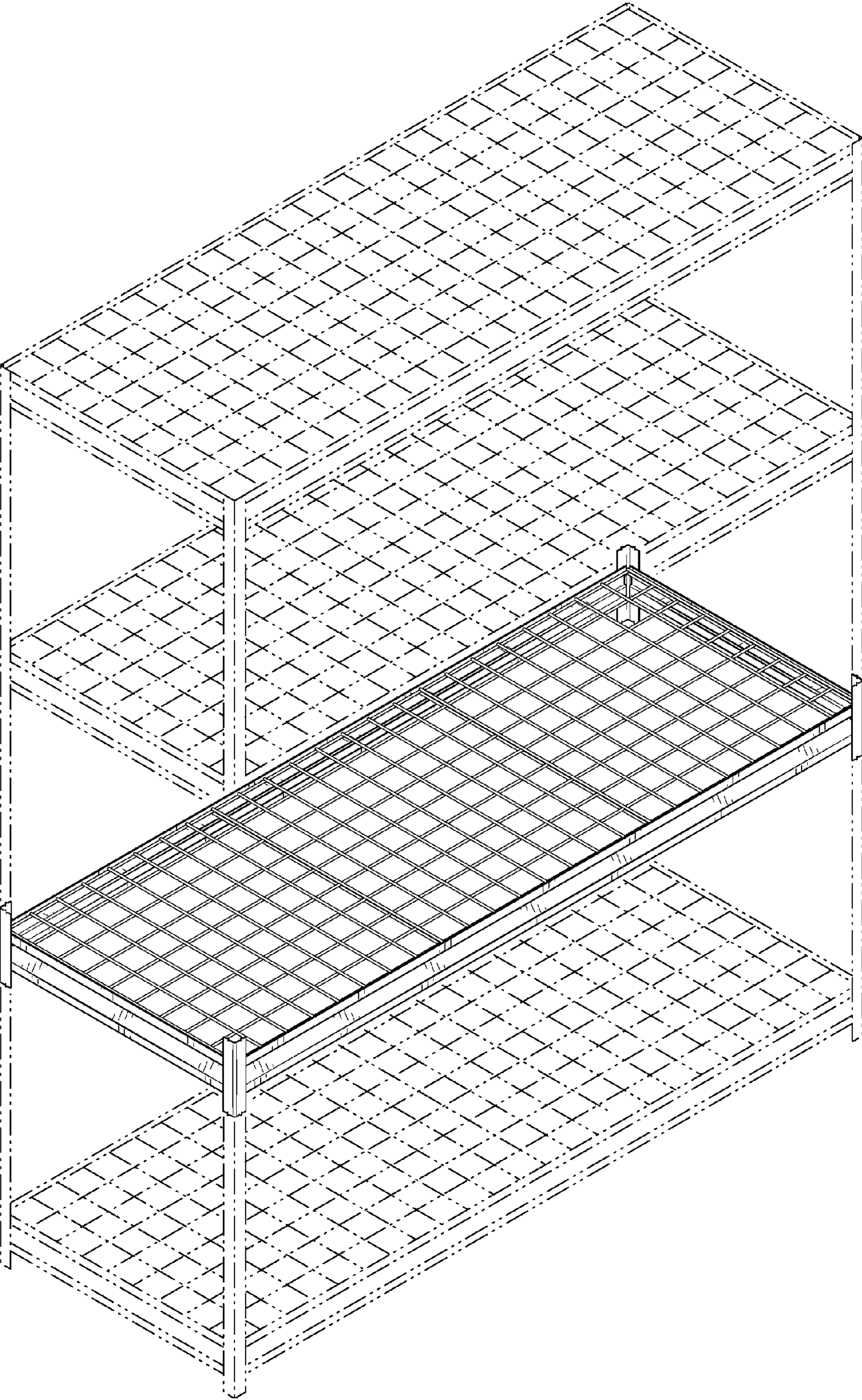

FIG. 9

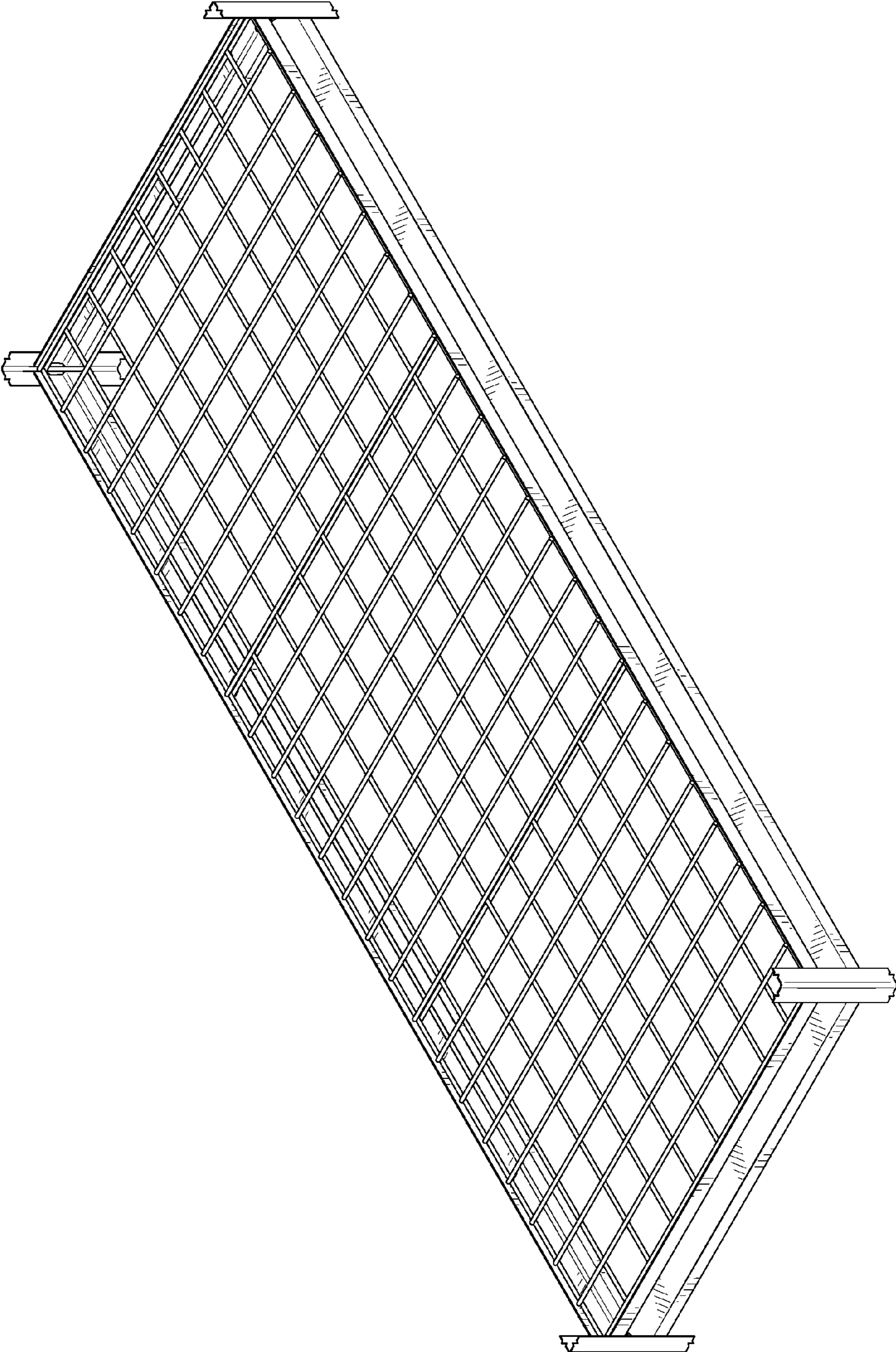

FIG. 10

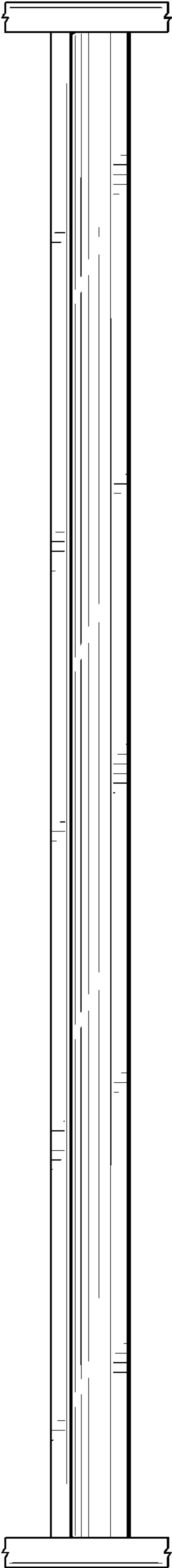

FIG. 11

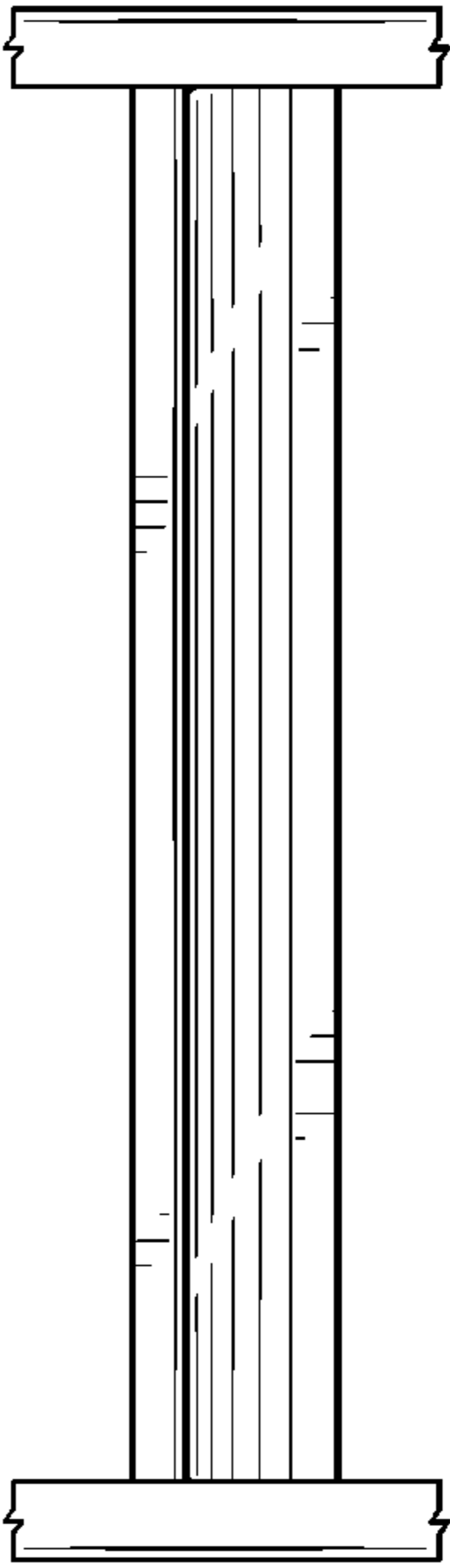

FIG. 12

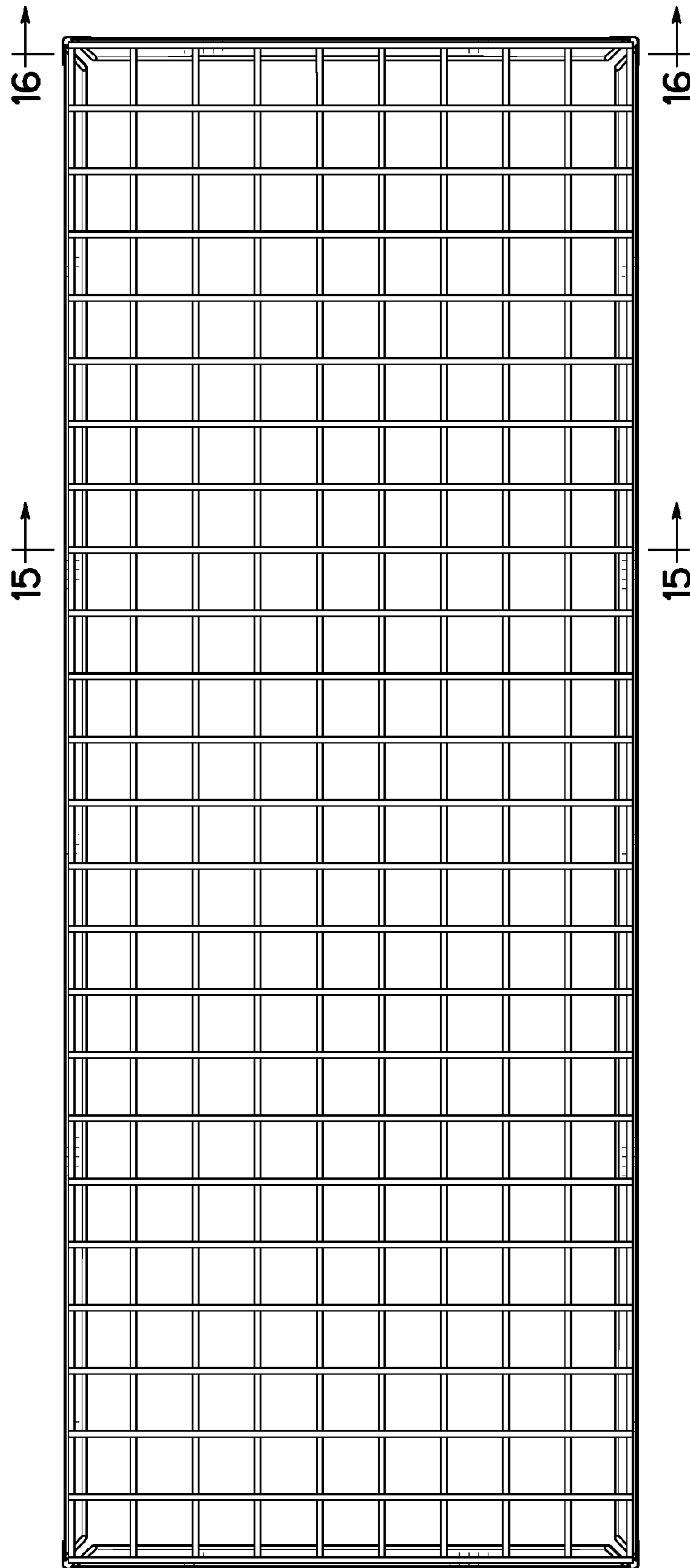

FIG. 13

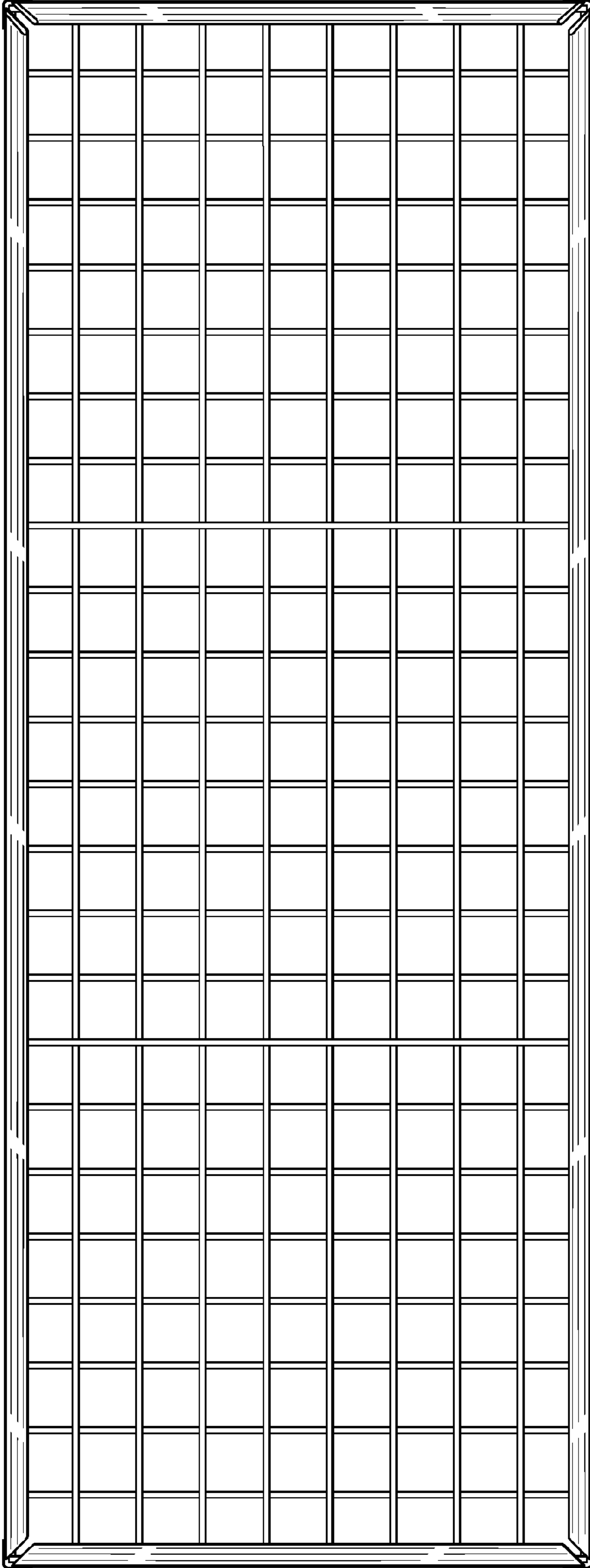

FIG. 14

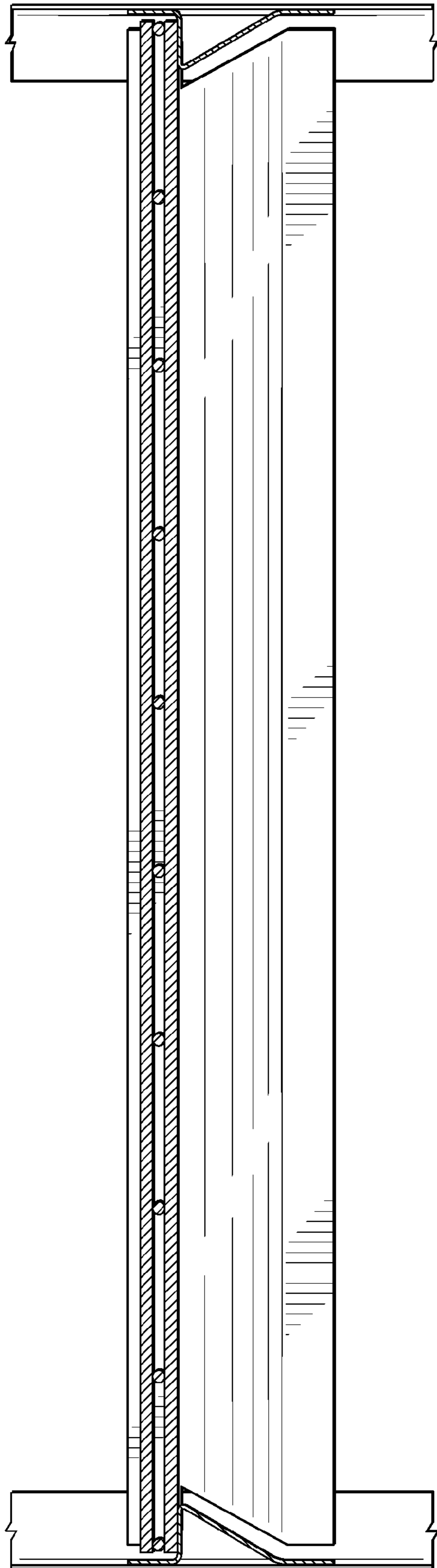

FIG. 15

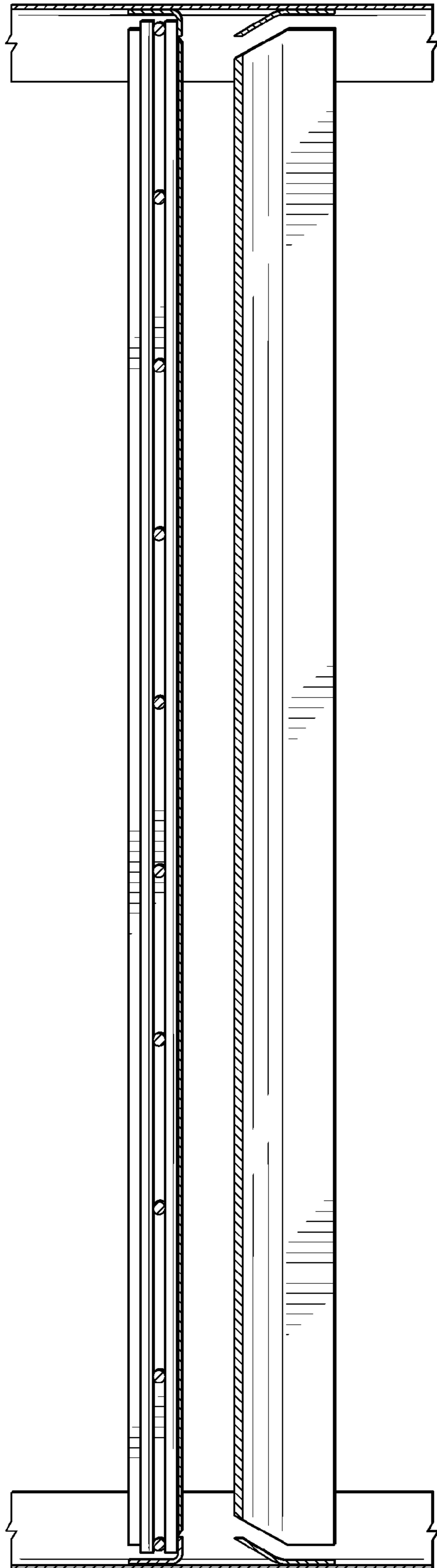

FIG. 16