



US00D597257S

(12) **United States Design Patent**
Uneno et al.

(10) **Patent No.:** **US D597,257 S**
(45) **Date of Patent:** **** Jul. 28, 2009**

(54) **LIPSTICK CASE**

(75) Inventors: **Yuji Uneno**, Tokyo (JP); **Mao Komai**,
Tokyo (JP); **Asako Hase**, Tokyo (JP)

(73) Assignee: **Shiseido Co., Ltd.**, Tokyo (JP)

(**) Term: **14 Years**

(21) Appl. No.: **29/309,827**

(22) Filed: **Oct. 22, 2008**

(51) **LOC (9) Cl.** **28-03**

(52) **U.S. Cl.** **D28/85**

(58) **Field of Classification Search** D28/76,
D28/85-90; 132/320, 318; 401/68-79; 206/385,
206/823, 581; D9/503-505, 529
See application file for complete search history.

(56) **References Cited**

U.S. PATENT DOCUMENTS

D298,364 S *	11/1988	Simonetti	D28/85
D452,350 S *	12/2001	Huang	D28/76
D539,982 S *	4/2007	Nobuto et al.	D28/76
D541,478 S *	4/2007	Nobuto et al.	D28/85

* cited by examiner

Primary Examiner—Jennifer Rivard
(74) *Attorney, Agent, or Firm*—Manabu Kanesaka

(57) **CLAIM**

The ornamental design for a lipstick case, as shown and described.

DESCRIPTION

FIG. 1 is a perspective view of a lipstick case showing our new design;

FIG. 2 is a front view thereof;

FIG. 3 is a rear view thereof;

FIG. 4 is a plan view thereof;

FIG. 5 is a bottom view thereof;

FIG. 6 is a right side view thereof;

FIG. 7 is a left side view thereof; and,

FIG. 8 is a perspective view of a main member of the lipstick case, wherein the cap is removed for convenience of illustration.

1 Claim, 3 Drawing Sheets

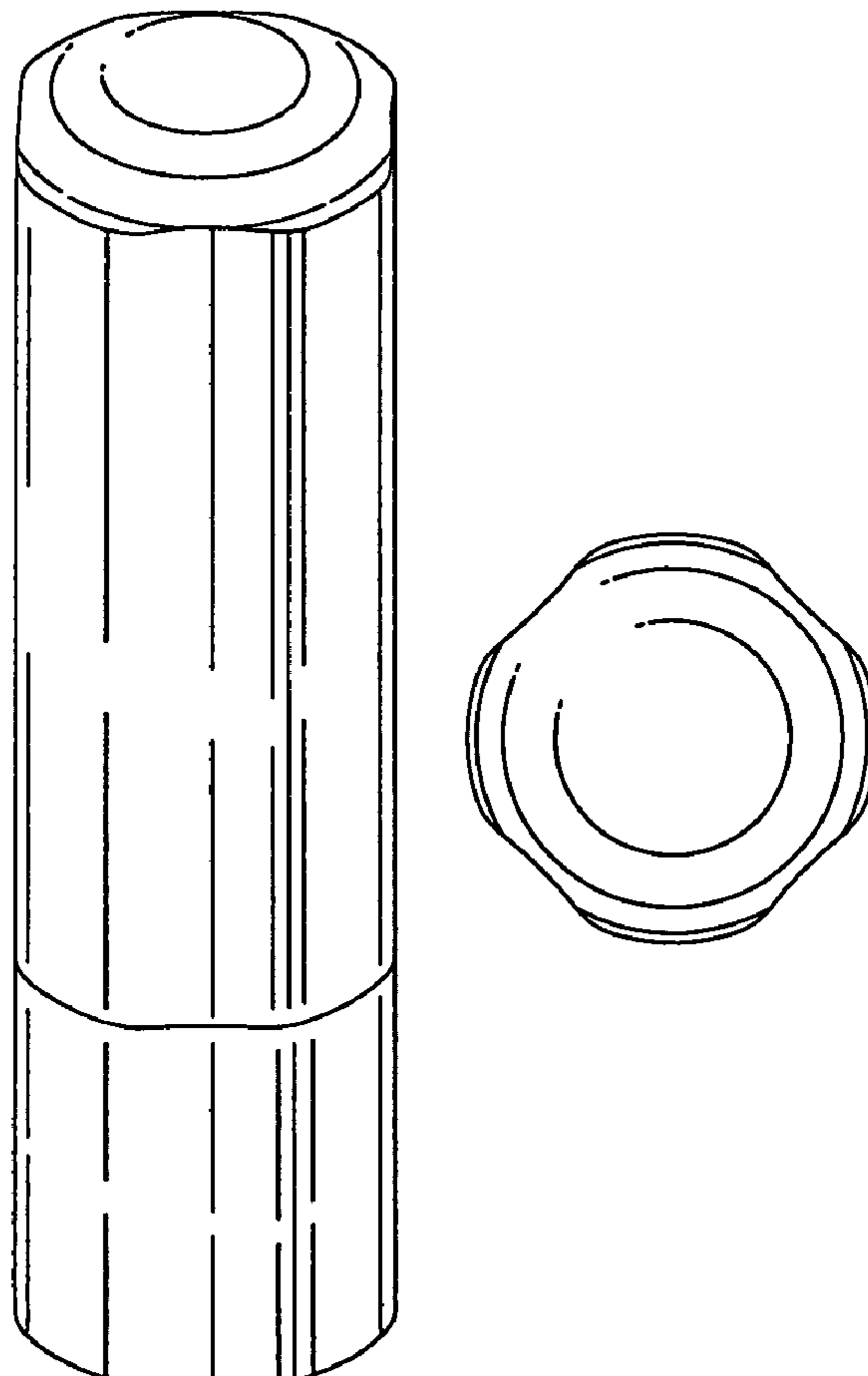

FIG. 1

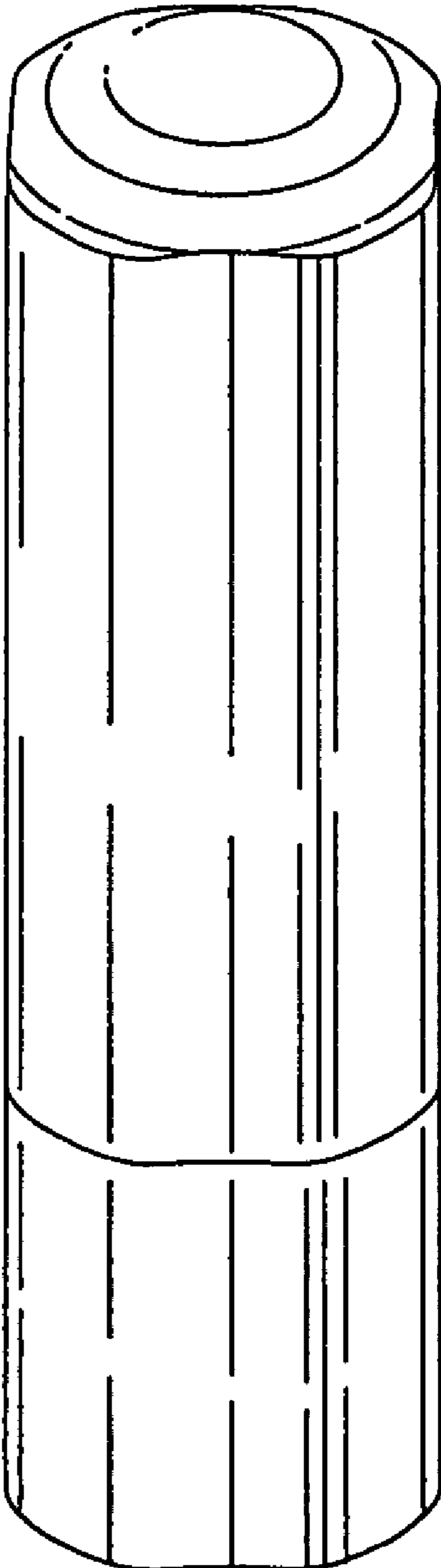

FIG.2

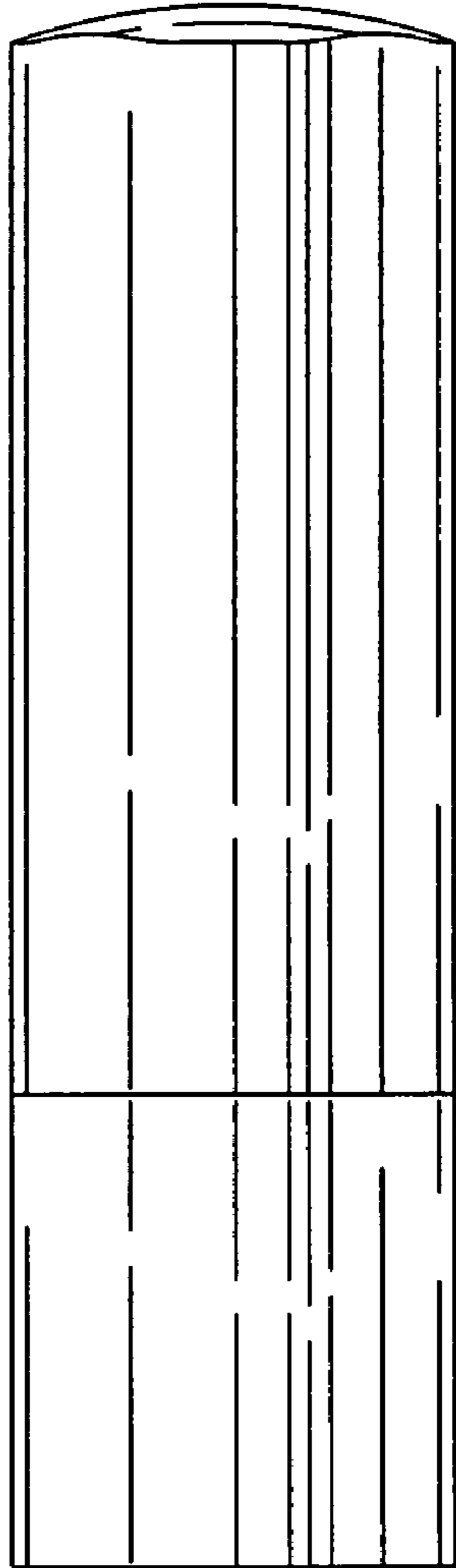

FIG.3



FIG.4

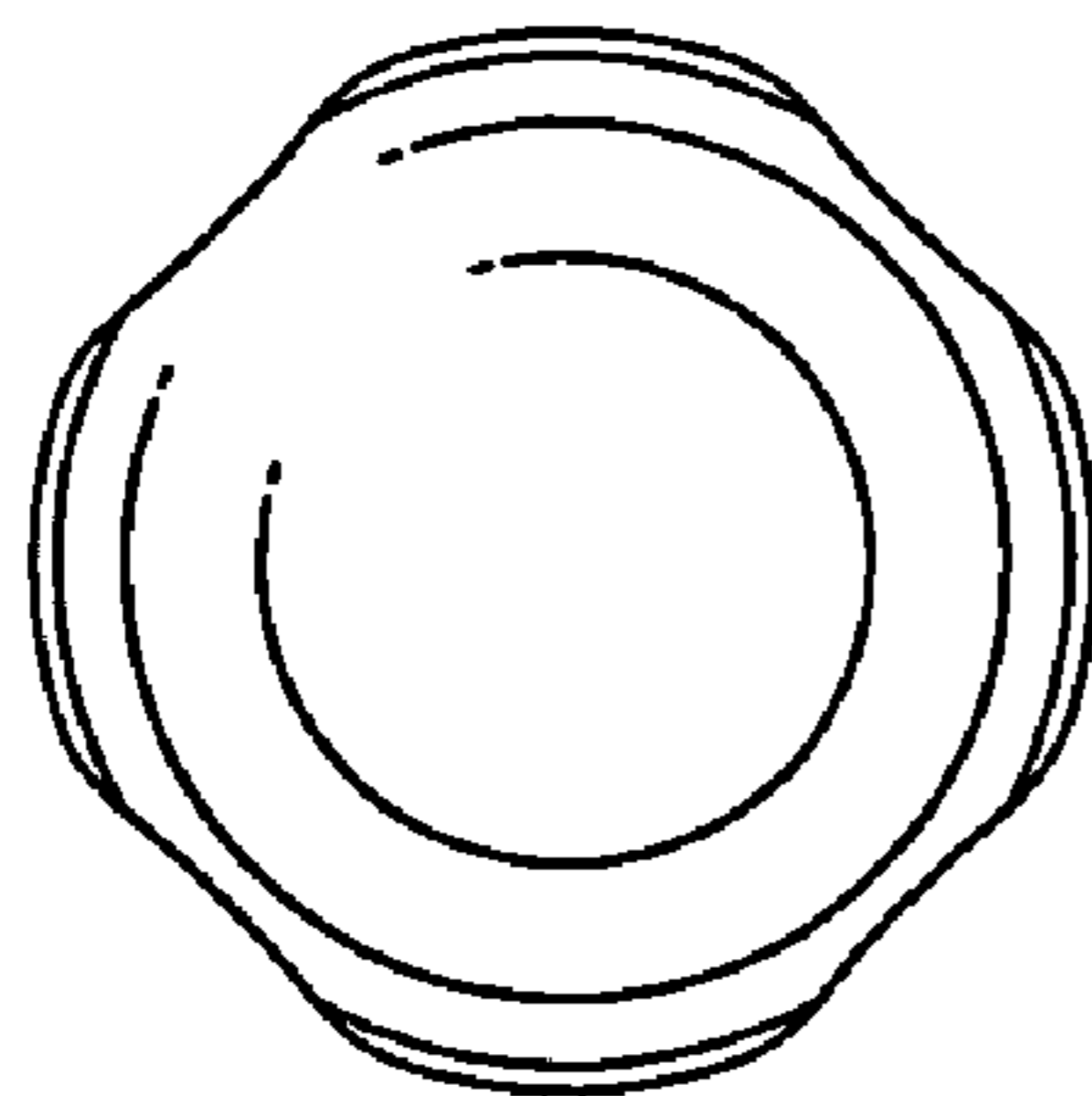

FIG.5

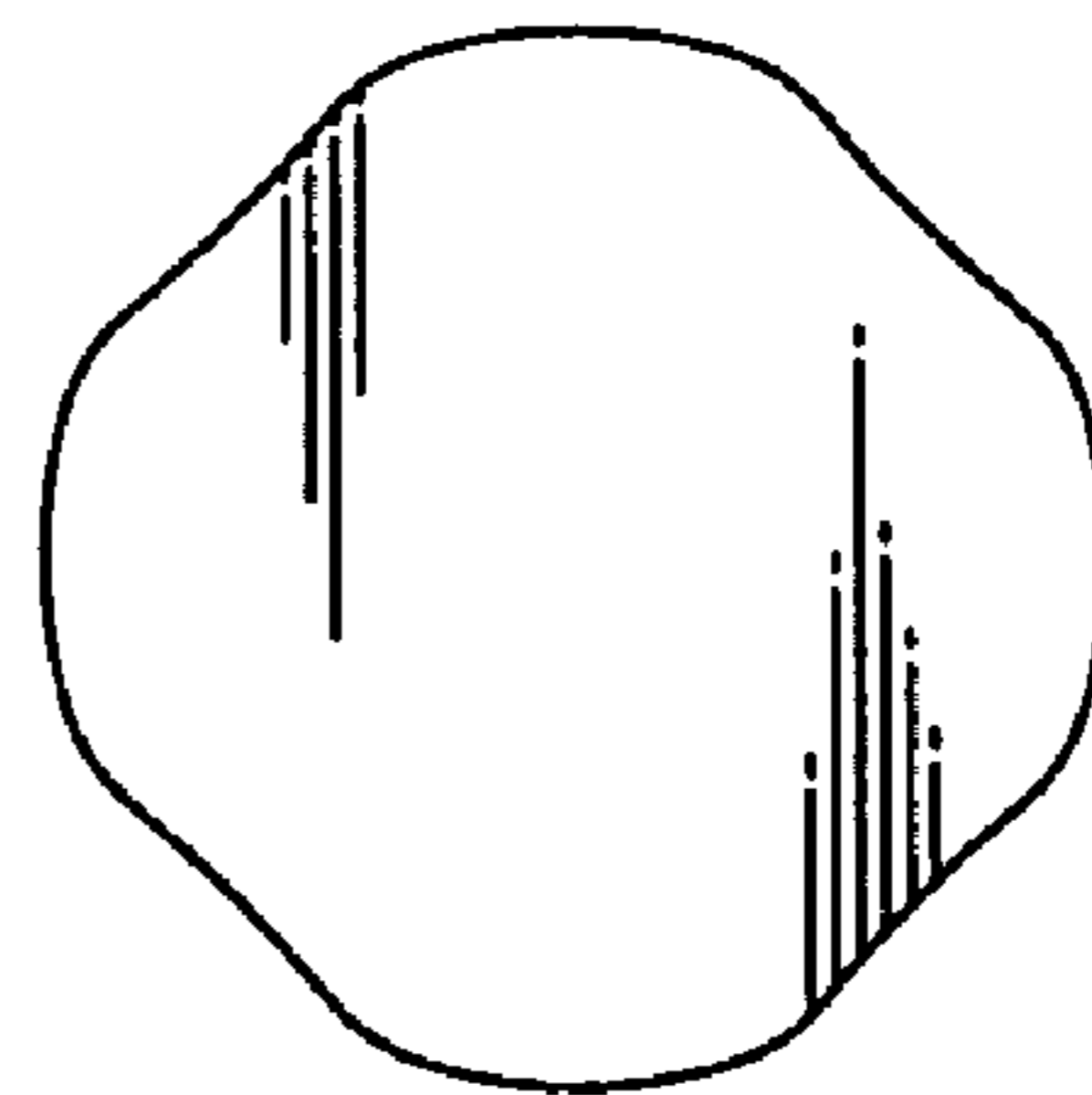

FIG.6

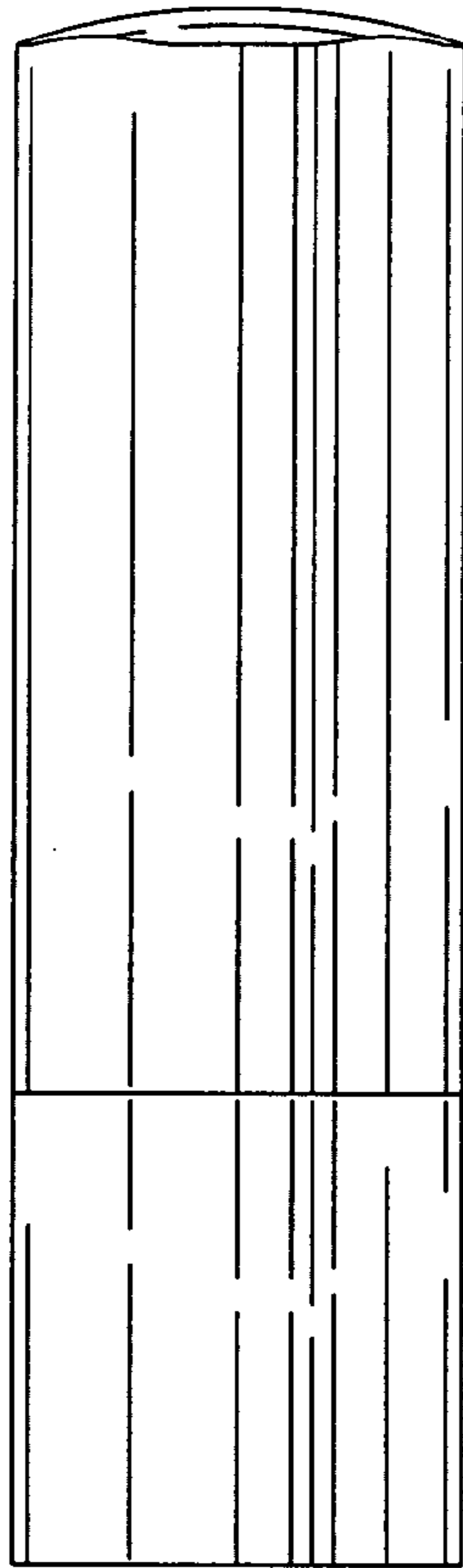

FIG.7

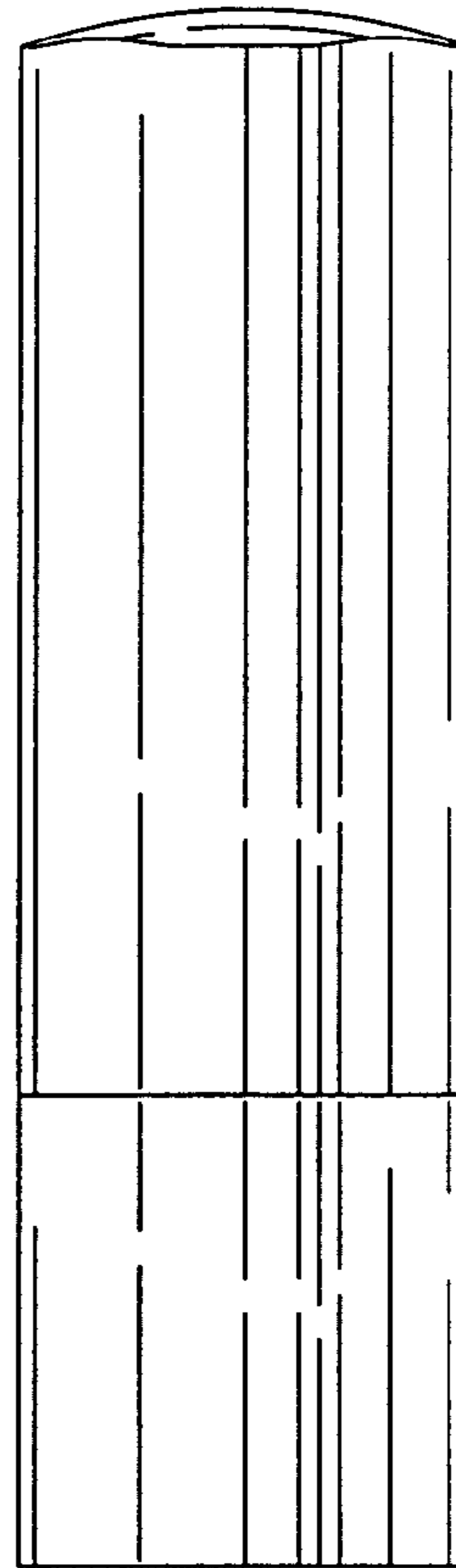

FIG.8

