

US00D597233S

(12) **United States Design Patent**
Teng

(10) **Patent No.:** **US D597,233 S**

(45) **Date of Patent:** **** Jul. 28, 2009**

(54) **FOG LIGHT RACK**

(76) Inventor: **Wei Cheng Teng**, No. 30-20, Lane 53,
Jyun-an Street, Shu-Lin City, Taipei
(TW)

(**) Term: **14 Years**

(21) Appl. No.: **29/332,441**

(22) Filed: **Feb. 17, 2009**

(30) **Foreign Application Priority Data**

Jan. 17, 2009 (TW) 98300212

(51) **LOC (9) Cl.** **26-06**

(52) **U.S. Cl.** **D26/28**

(58) **Field of Classification Search** D26/28-36;
362/459-468, 475-478, 485-487
See application file for complete search history.

(56) **References Cited**

U.S. PATENT DOCUMENTS

D556,925 S * 12/2007 Lin D26/28

D581,074 S * 11/2008 Starr D26/31

D585,150 S * 1/2009 Hung D26/28

* cited by examiner

Primary Examiner—Marcus A. Jackson

(74) *Attorney, Agent, or Firm*—Leong C. Lei

(57) **CLAIM**

The ornamental design for a fog light rack, as shown and described.

DESCRIPTION

FIG. 1 is a perspective view of a fog light rack showing my new design;

FIG. 2 is a front elevational view thereof;

FIG. 3 is a rear elevational view thereof;

FIG. 4 is a left side perspective view thereof;

FIG. 5 is a right side perspective view thereof;

FIG. 6 is a top plan view thereof;

FIG. 7 is a bottom plan view thereof; and,

FIG. 8 is another front elevational view thereof, with the automobile engaged.

The dotted line showing of the automobile is for illustrative purposes only and forms no part of the claimed design.

1 Claim, 6 Drawing Sheets

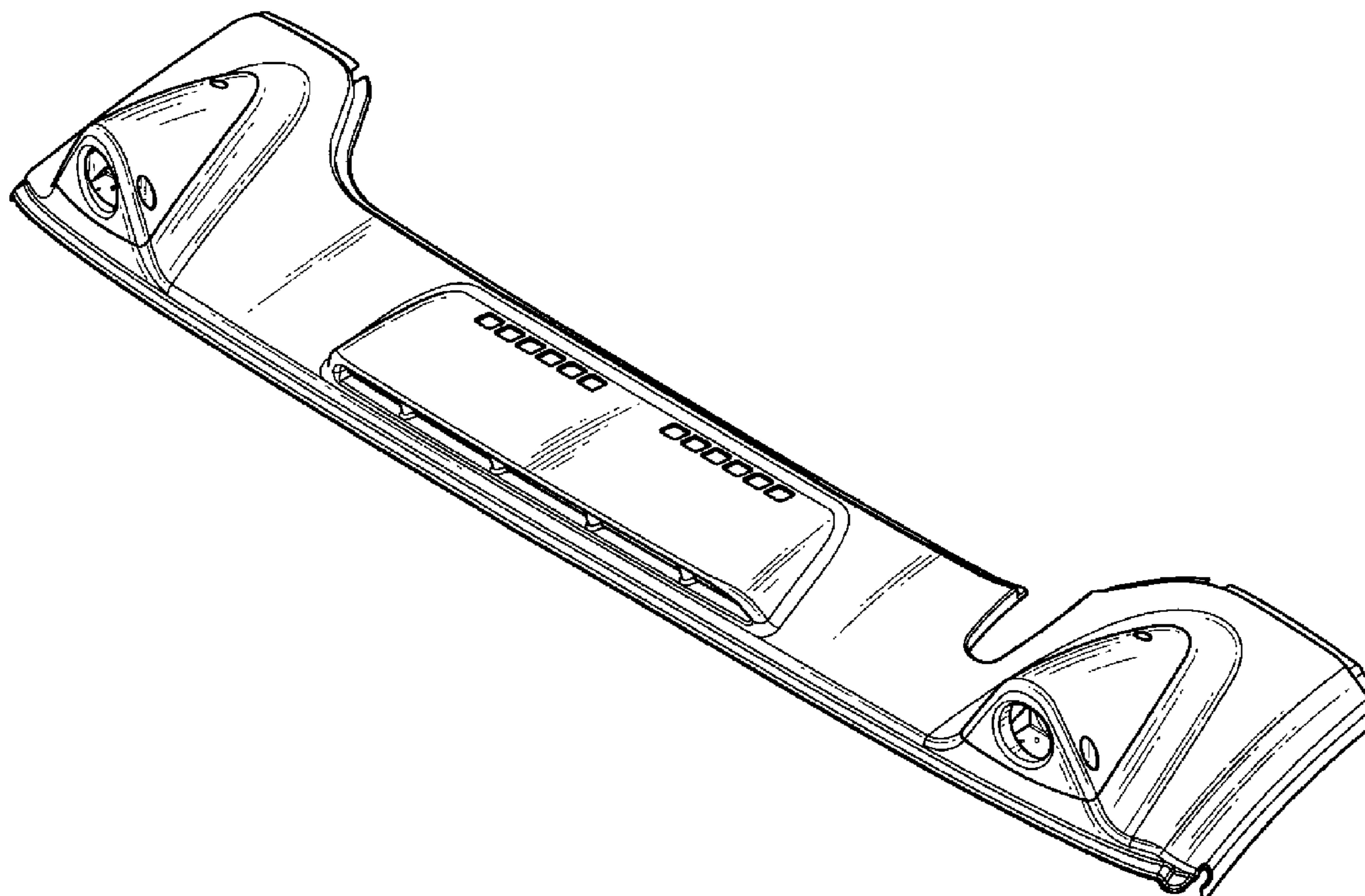

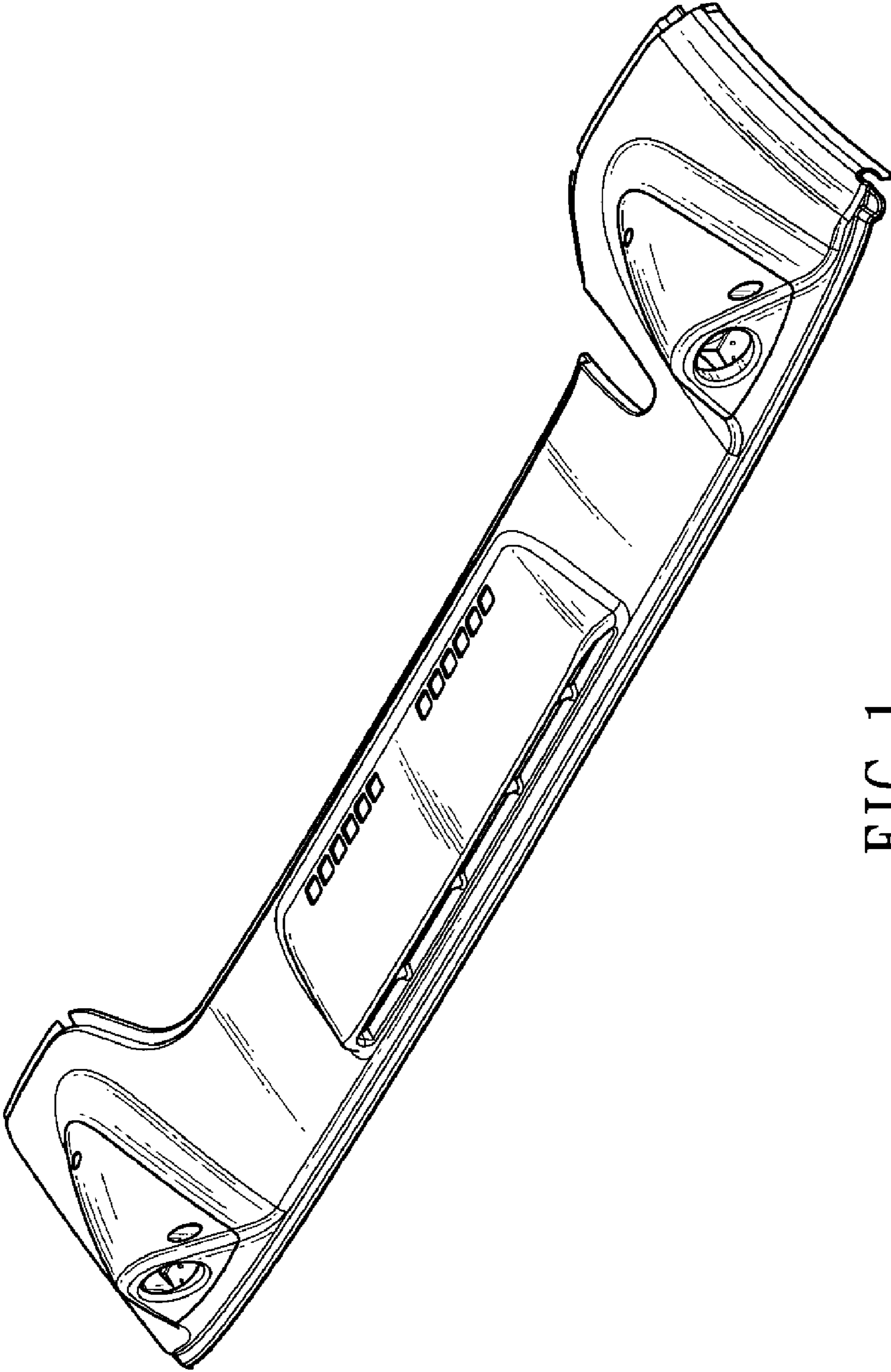

FIG. 1

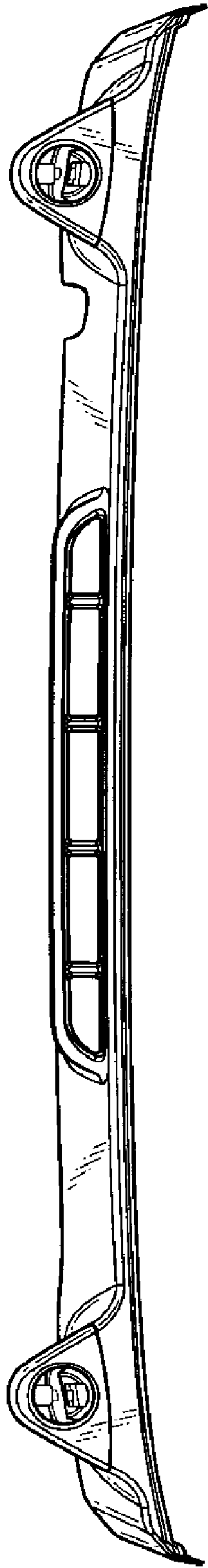

FIG. 2

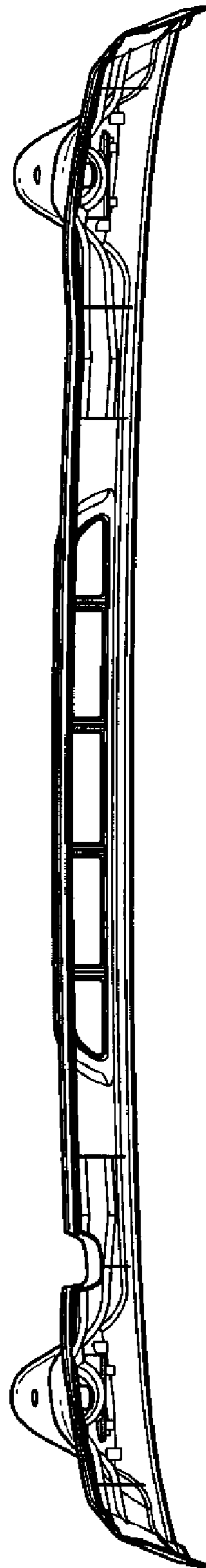

FIG. 3

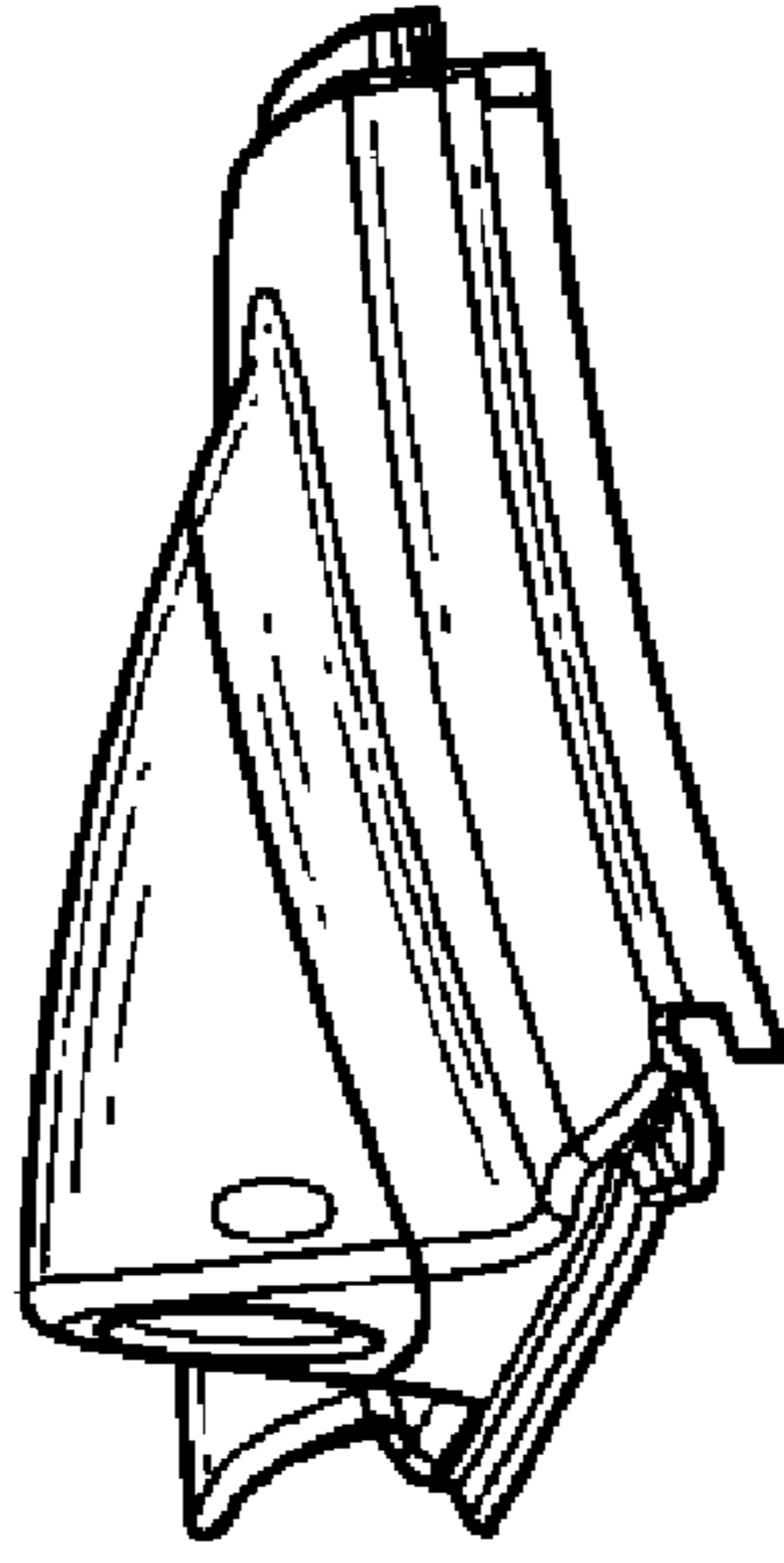

FIG. 5

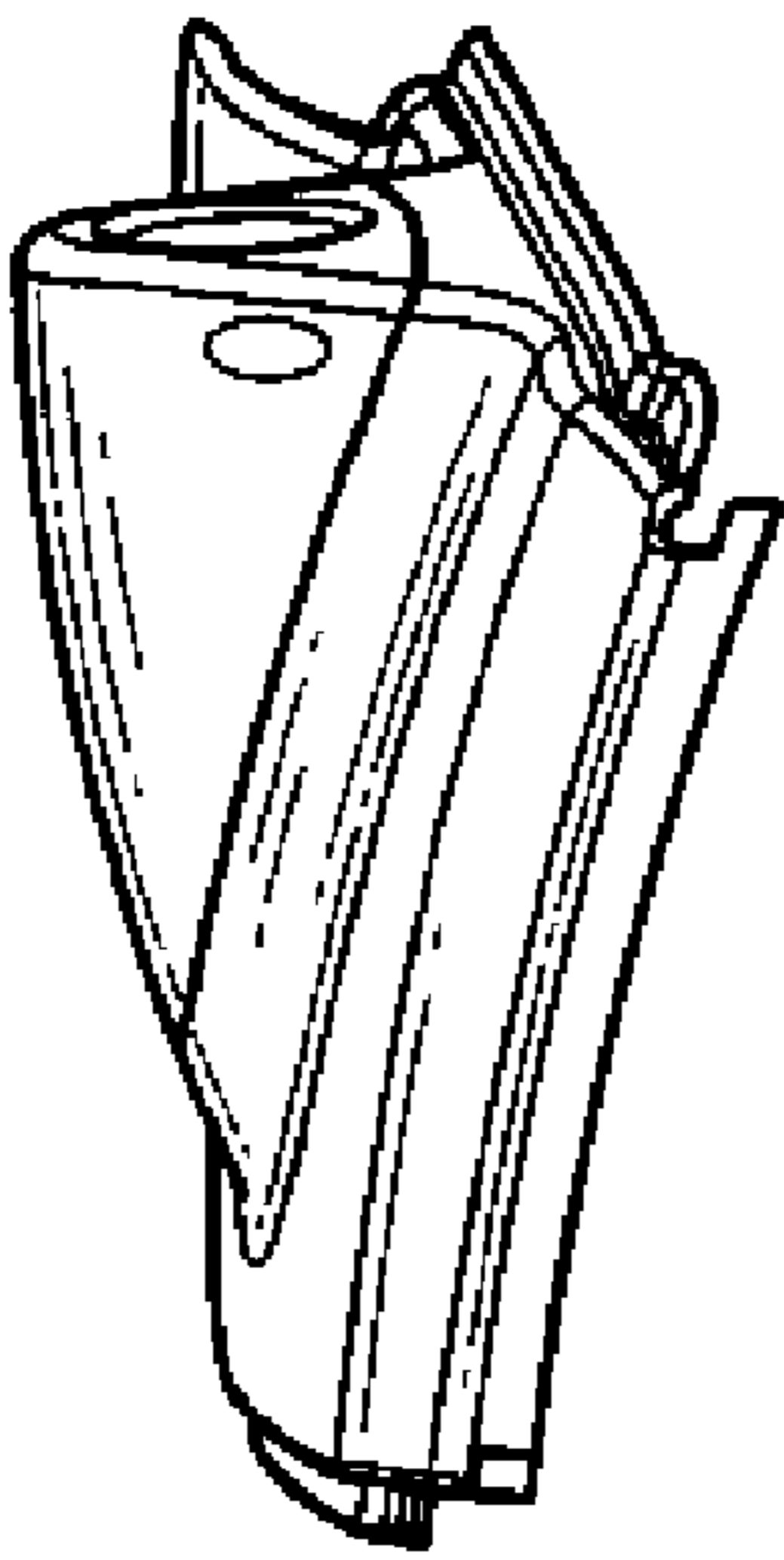

FIG. 4

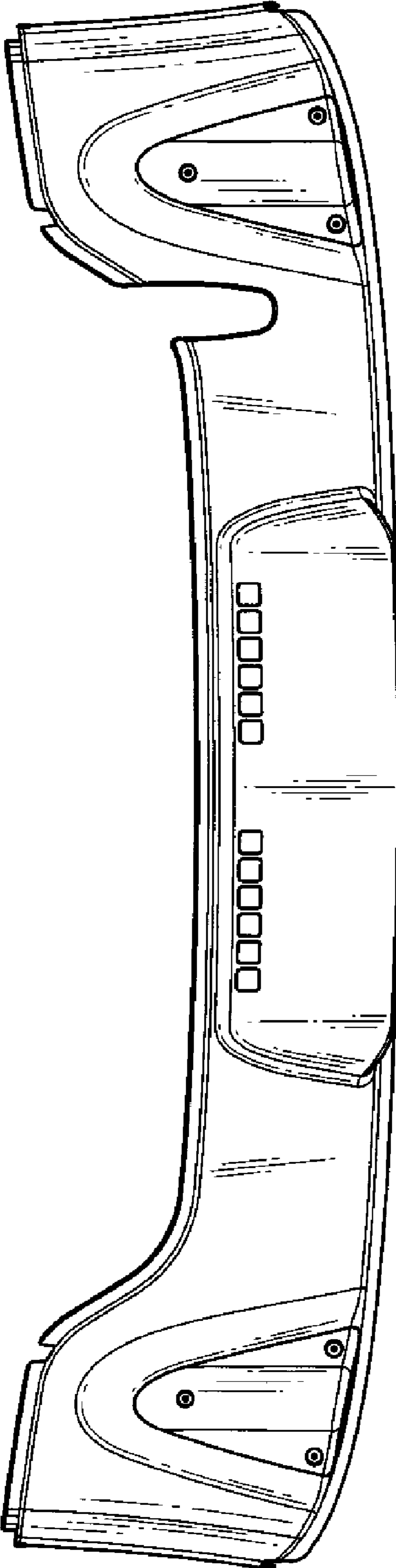

FIG. 6

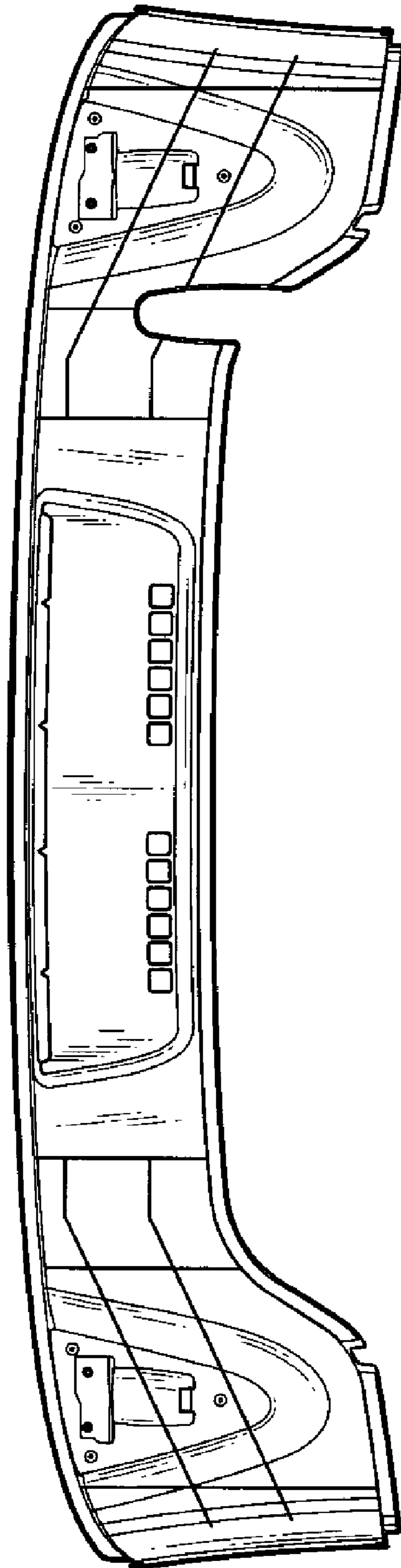

FIG. 7



FIG. 8