



US00D597212S

(12) **United States Design Patent**
Stiles

(10) **Patent No.:** **US D597,212 S**
(45) **Date of Patent:** **** Jul. 28, 2009**

(54) **RESTRAINT DEVICE**

(75) Inventor: **Mark A. Stiles**, Atlanta, GA (US)

(73) Assignee: **HANS Performance Products**, Atlanta, GA (US)

(**) Term: **14 Years**

(21) Appl. No.: **29/298,467**

(22) Filed: **Dec. 5, 2007**

(51) **LOC (9) Cl.** **24-01**

(52) **U.S. Cl.** **D24/191**

(58) **Field of Classification Search** D24/188-192;
602/4-5, 17-18, 20-21, 62; 128/77, 94,
128/97.1, 869, 874, 878-880, DIG. 15, DIG. 23;
606/241; 411/339

See application file for complete search history.

(56) **References Cited**

U.S. PATENT DOCUMENTS

2,818,063	A *	12/1957	Smith et al.	602/18
2,904,040	A *	9/1959	Hale	602/18
3,522,804	A *	8/1970	Towbin	128/869
4,034,747	A *	7/1977	Leroy	602/18
4,538,597	A *	9/1985	Lerman	602/18
4,562,833	A *	1/1986	Pujals, Jr.	602/18
4,638,510	A	1/1987	Hubbard	
4,708,129	A *	11/1987	Pujals, Jr.	602/18
4,757,554	A *	7/1988	Blair	2/468
4,854,306	A *	8/1989	Pujals, Jr.	602/18
4,909,459	A	3/1990	Patterson	
5,003,968	A *	4/1991	Mars	602/17
5,123,408	A *	6/1992	Gaines	602/17
5,201,702	A *	4/1993	Mars	602/17
5,205,813	A *	4/1993	Schmidt	602/17
5,267,708	A	12/1993	Monson et al.	
5,409,450	A *	4/1995	Donelson	602/18

5,797,713	A *	8/1998	Tweardy et al.	411/339
6,009,566	A	1/2000	Hubbard	
6,254,560	B1 *	7/2001	Tweardy et al.	602/18
6,751,809	B1	6/2004	Cooper et al.	
6,786,554	B1 *	9/2004	Zahiri	297/393
6,810,535	B1	11/2004	Moloney	
7,371,221	B1 *	5/2008	Baker	602/18
2007/0010771	A1	1/2007	Leatt	
2007/0067896	A1	3/2007	Sargent	
2007/0156072	A1	7/2007	Leatt	

* cited by examiner

Primary Examiner—Robert M. Spear

Assistant Examiner—Susan E Krakower

(74) *Attorney, Agent, or Firm*—Ballard Spahr Andrews & Ingersoll, LLP

(57) **CLAIM**

The ornamental design for a restraint device, as shown and described.

DESCRIPTION

FIG. 1 is a perspective view of a restraint device of the present invention;

FIG. 2 is a rear elevational view of the restraint device of FIG. 1;

FIG. 3 is a left side elevational view of the restraint device of FIG. 1, the right side elevational view being a mirror image of the right side elevational view;

FIG. 4 is a front elevational view of the restraint device of FIG. 1;

FIG. 5 is a top plan view of the restraint device of FIG. 1; and,

FIG. 6 is a bottom plan view of the restraint device of FIG. 1.

The broken lines illustrate portions of the restraint device which form no part of the claimed design.

1 Claim, 5 Drawing Sheets

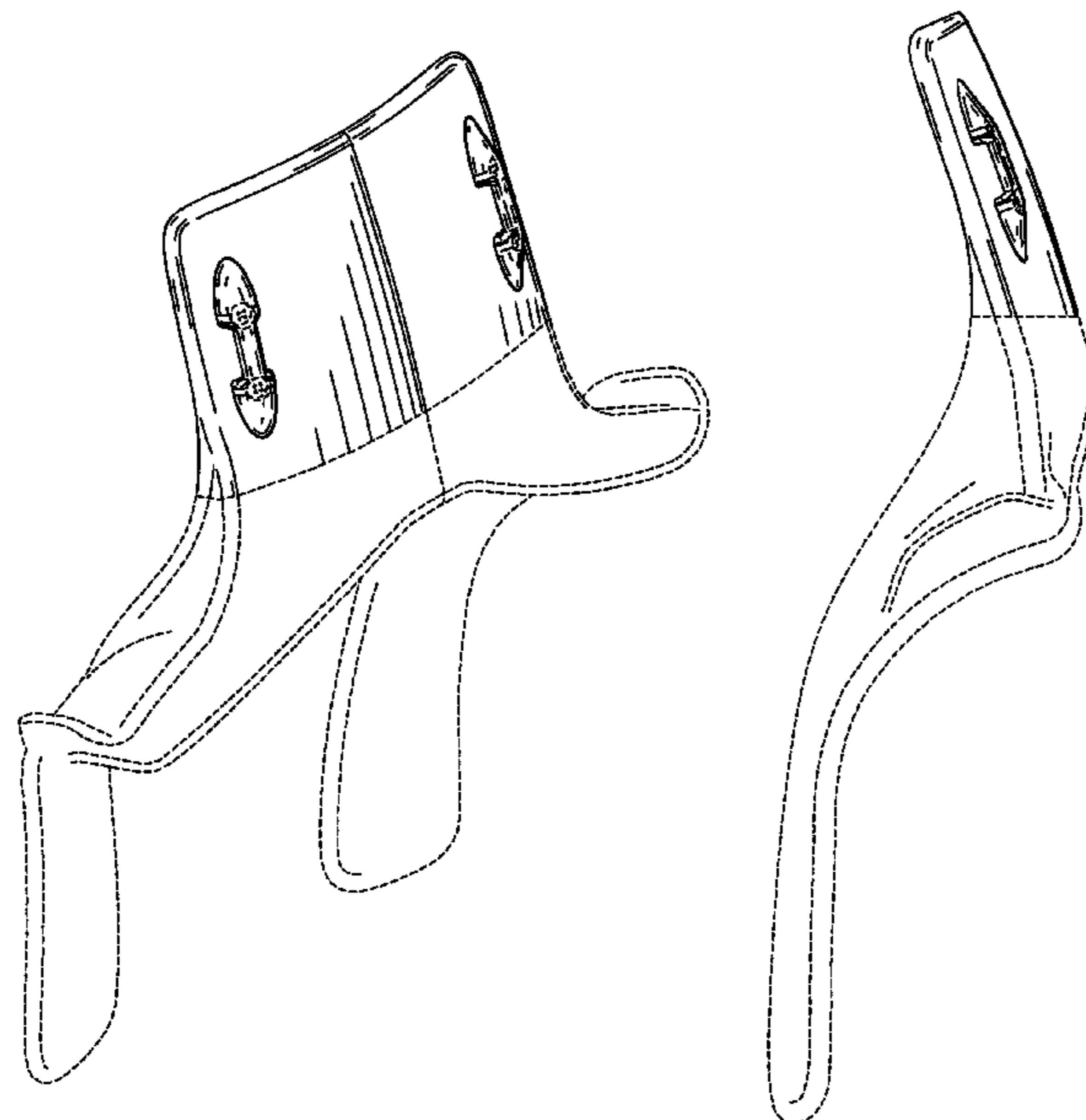

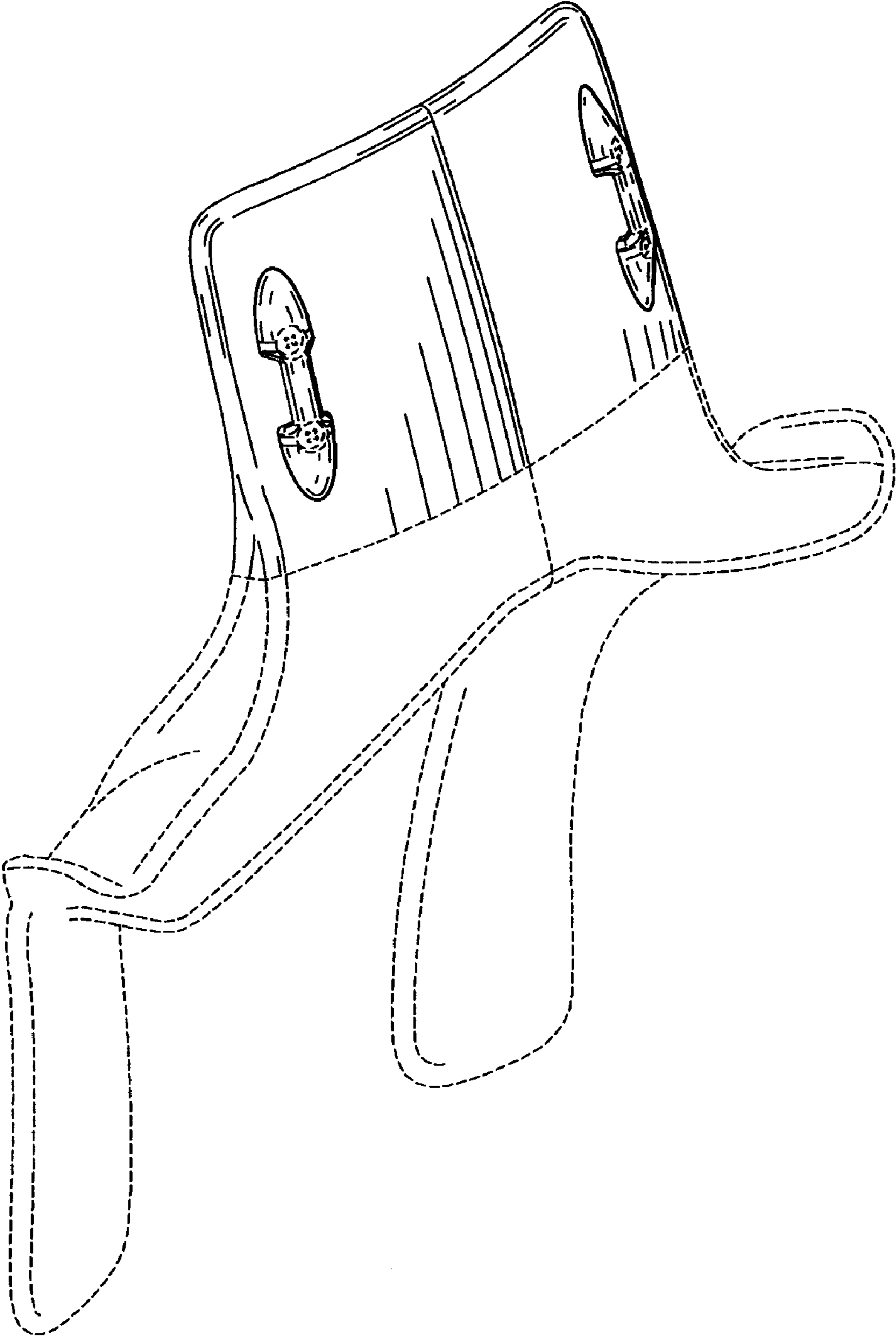

FIG. 1

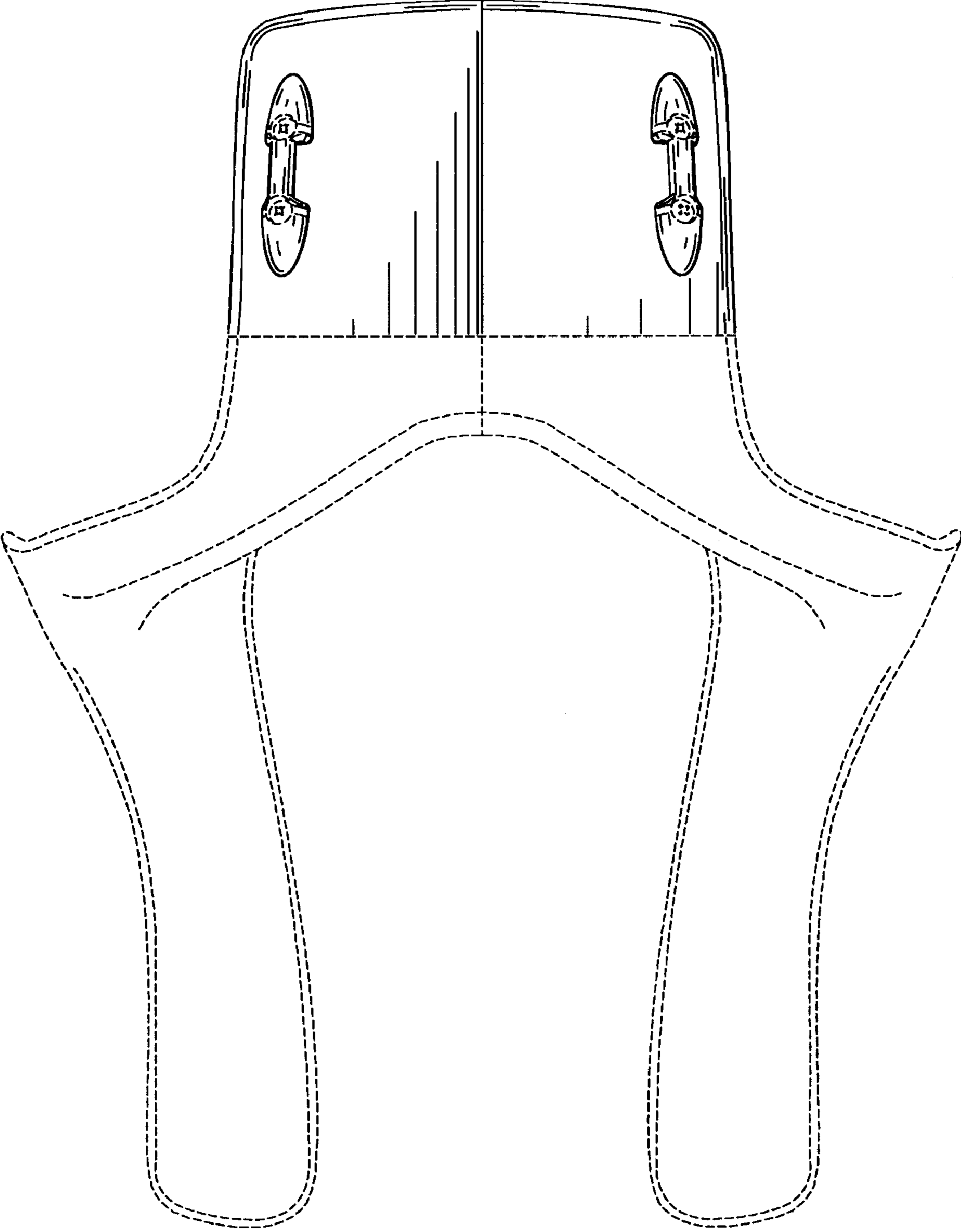

FIG. 2

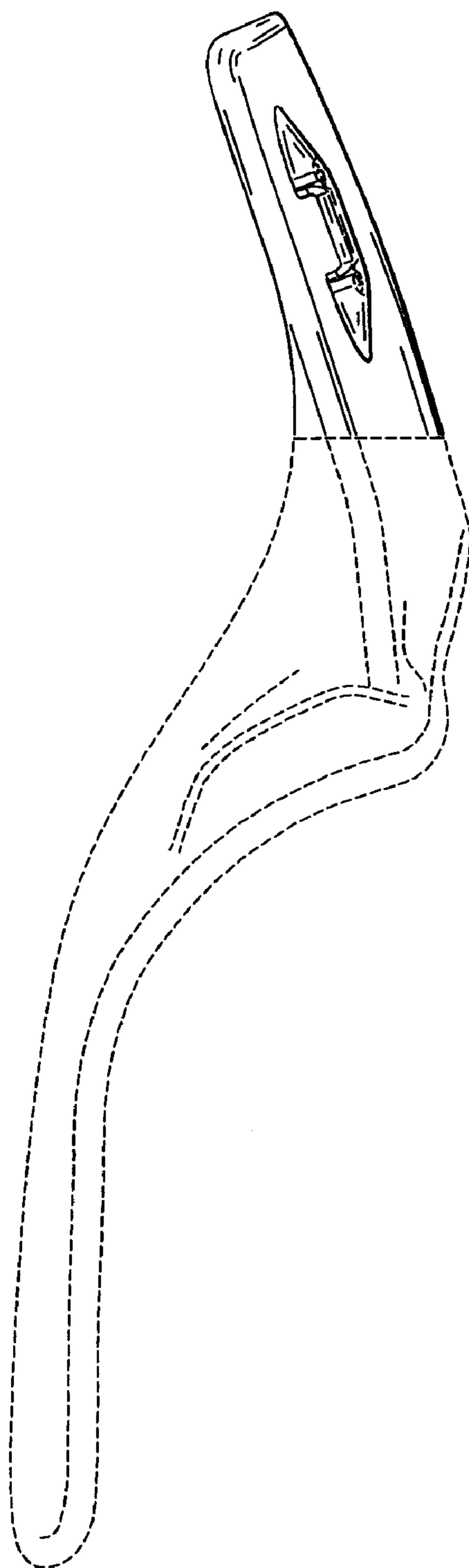

FIG. 3

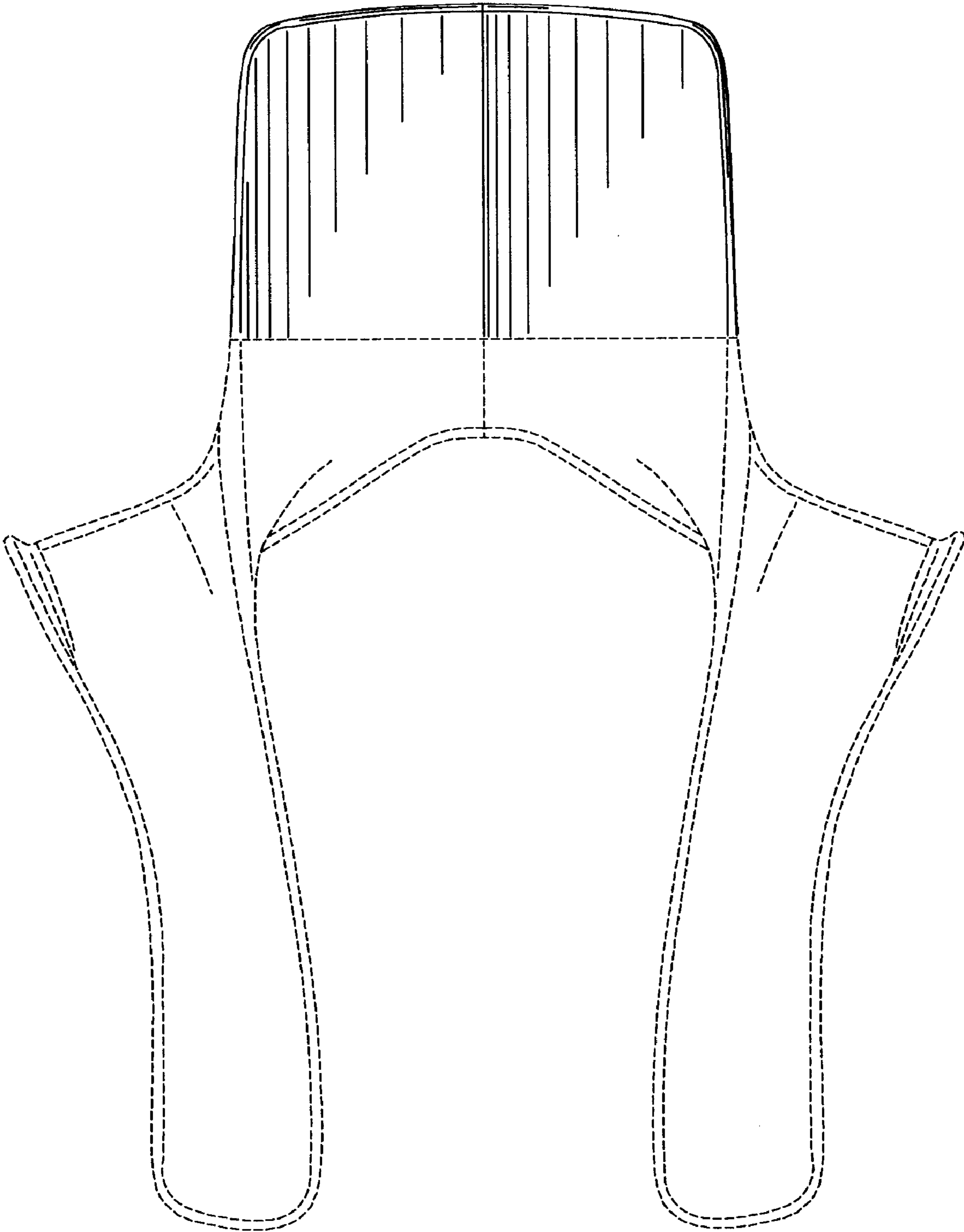

FIG. 4

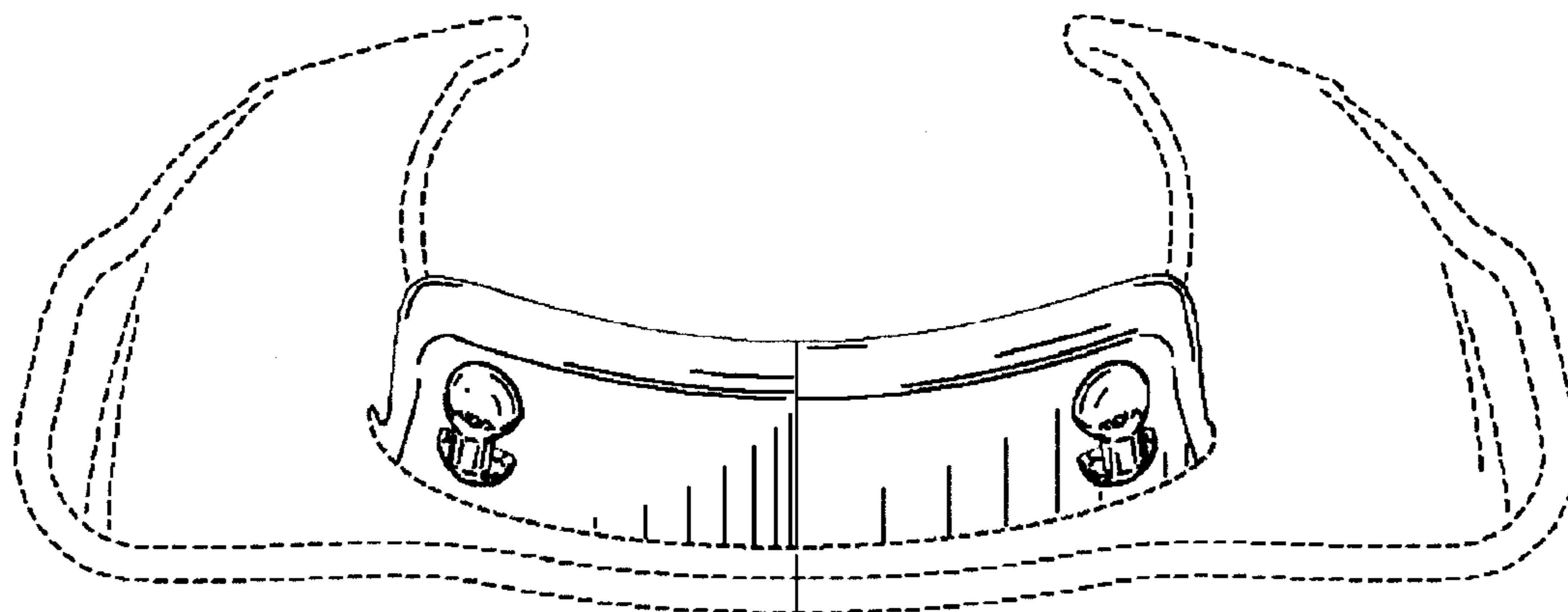

FIG. 5

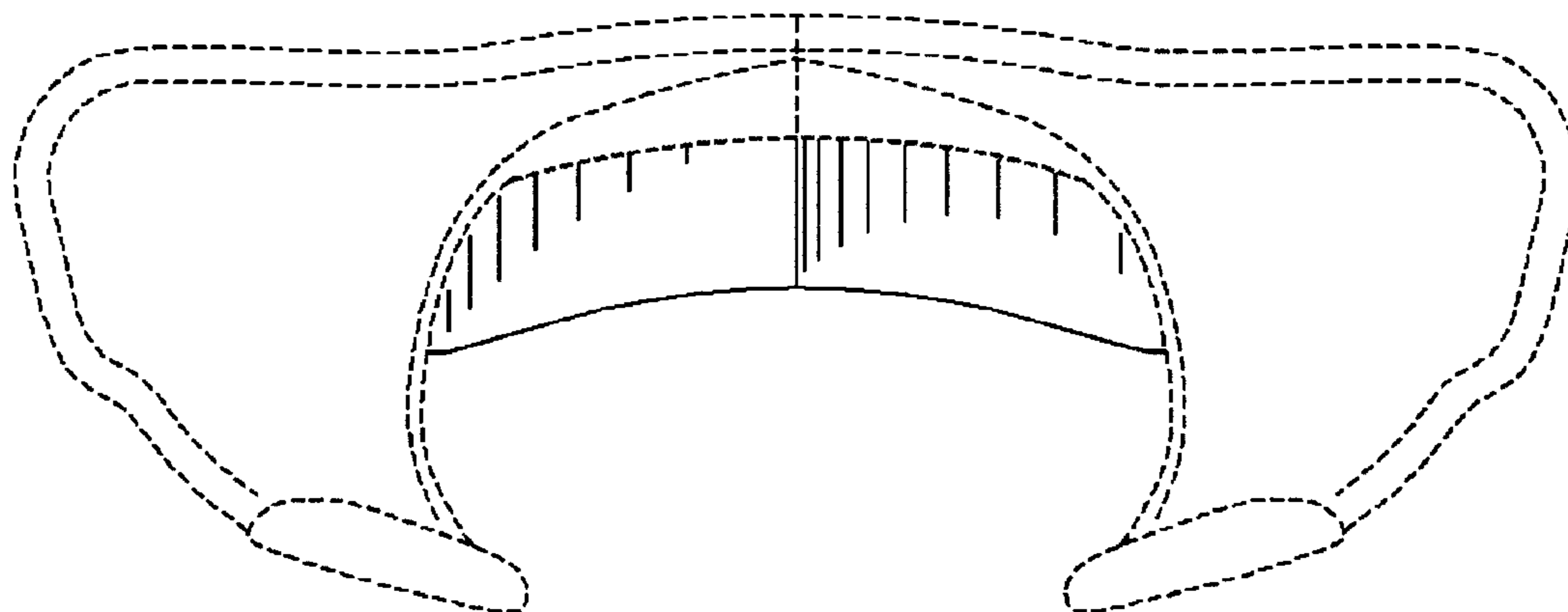

FIG. 6