



US00D597208S

(12) **United States Design Patent**
Ericsson et al.

(10) **Patent No.:** **US D597,208 S**
(45) **Date of Patent:** **** Jul. 28, 2009**

(54) **DENTAL INSTRUMENT**

(75) Inventors: **Dan Ericsson**, Malmö (SE); **Per Larsson**, Stockholm (SE); **Stefan Leffler**, Jarfalla (SE); **Olof Larsson**, Huddinge (SE)

(73) Assignee: **Directa AB**, Upplands Vasby (SE)

(**) Term: **14 Years**

(21) Appl. No.: **29/306,443**

(22) Filed: **Apr. 9, 2008**

(30) **Foreign Application Priority Data**

Oct. 10, 2007 (EM) 000805684-0001

(51) **LOC (9) Cl.** **24-03**

(52) **U.S. Cl.** **D24/152; D28/65**

(58) **Field of Classification Search** D24/155-157;
606/60, 61, 73, 95, 213, 281, 292, 70, 71,
606/76, 291, 246, 248, 249, 247, 280, 283;
623/17.11, 17.12, 17.13, 17.14, 17.15, 17.16,
623/23.61, 23.56, 247, 213, 286; D15/143,
D15/139; 433/173, 176, 49, 70, 168.1, 38,
433/39, 40, 47; D8/387, 388, 393; D29/108,
D29/100; 128/859, 861, 862; 72/68, 299,
72/316; D28/65, 66, 67

See application file for complete search history.

(56) **References Cited**

U.S. PATENT DOCUMENTS

D24,691 S * 9/1895 McChesney D28/65
943,353 A * 12/1909 Ivory 433/39
1,240,731 A * 9/1917 Kinehan 433/10

2,674,799 A * 4/1954 Fraser 433/141
2,771,677 A * 11/1956 Curry 433/39
4,481,162 A * 11/1984 Huffman 433/54
D333,534 S * 2/1993 Dizon D28/65
D374,745 S * 10/1996 Harris D28/65
6,234,793 B1 * 5/2001 Brattesani et al. 433/39
6,749,429 B1 * 6/2004 Haraden et al. 433/39
D496,493 S * 9/2004 Klawuhn et al. D28/65
D523,992 S * 6/2006 Le D28/65
7,077,651 B2 * 7/2006 Anderson 433/139
D548,885 S * 8/2007 Cafri D28/65
D575,004 S * 8/2008 Jansheski et al. D28/65

* cited by examiner

Primary Examiner—Charles A Rademaker

(74) *Attorney, Agent, or Firm*—Dickstein Shapiro LLP

(57) **CLAIM**

The ornamental design for a dental instrument, as shown and described.

DESCRIPTION

FIG. 1 is a perspective view of a dental instrument showing our new design;

FIG. 2 is another perspective view thereof from the opposite side;

FIG. 3 is a side elevation thereof;

FIG. 4 is a side elevation of the side opposite shown in FIG. 3;

FIG. 5 is a bottom plan view thereof;

FIG. 6 is a top plan view thereof;

FIG. 7 is a front elevation thereof; and,

FIG. 8 is a rear elevation thereof.

1 Claim, 4 Drawing Sheets

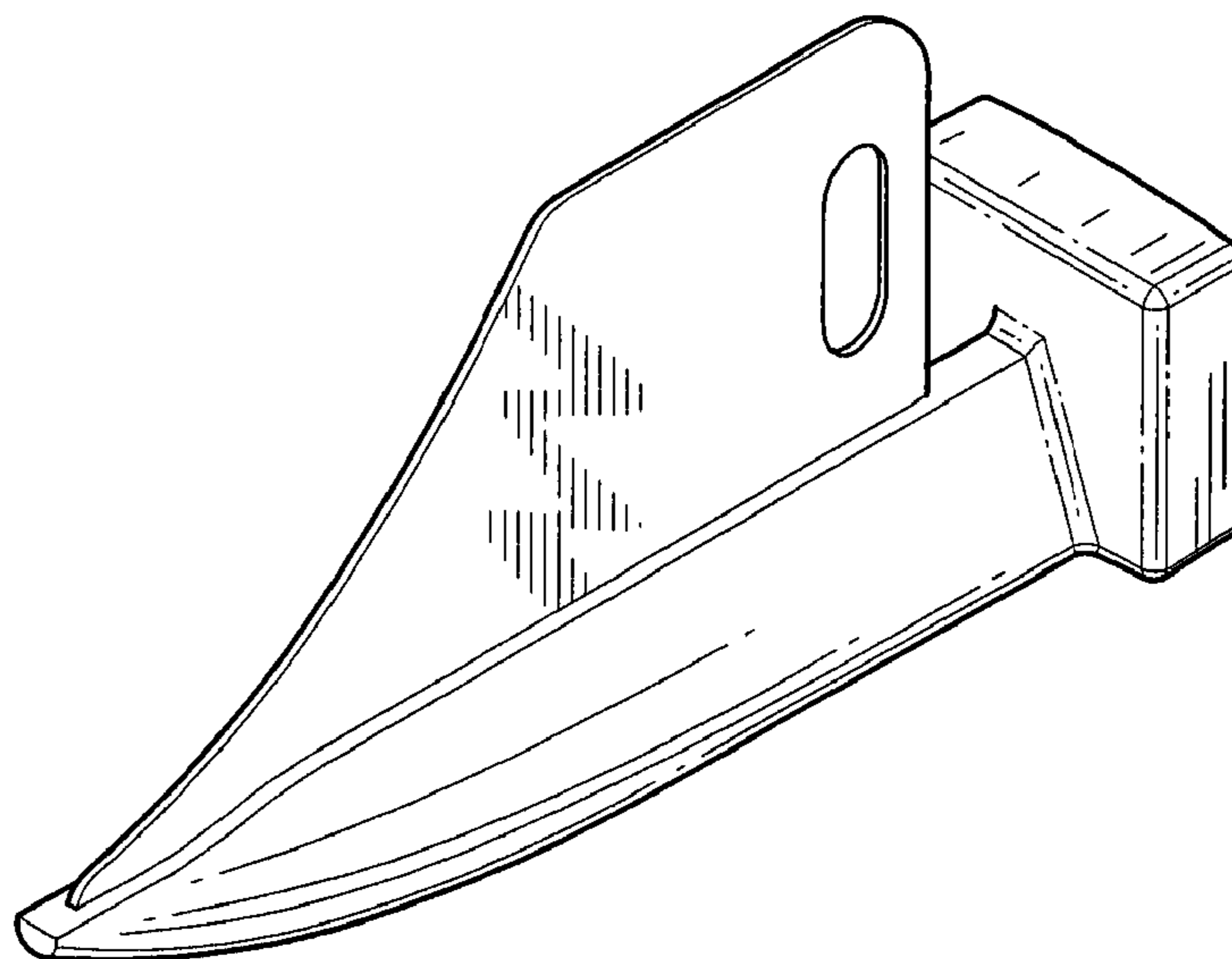

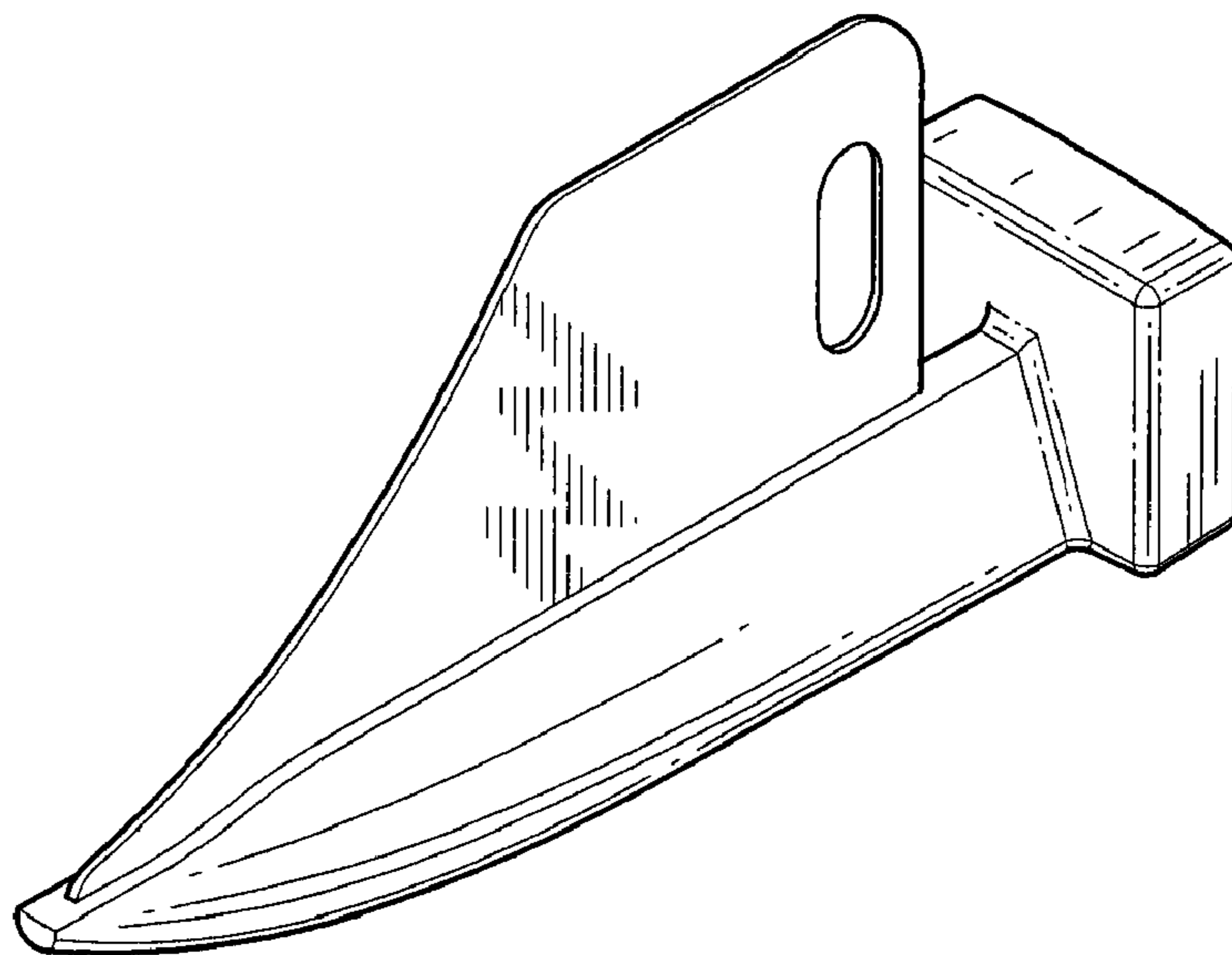

FIG. 1

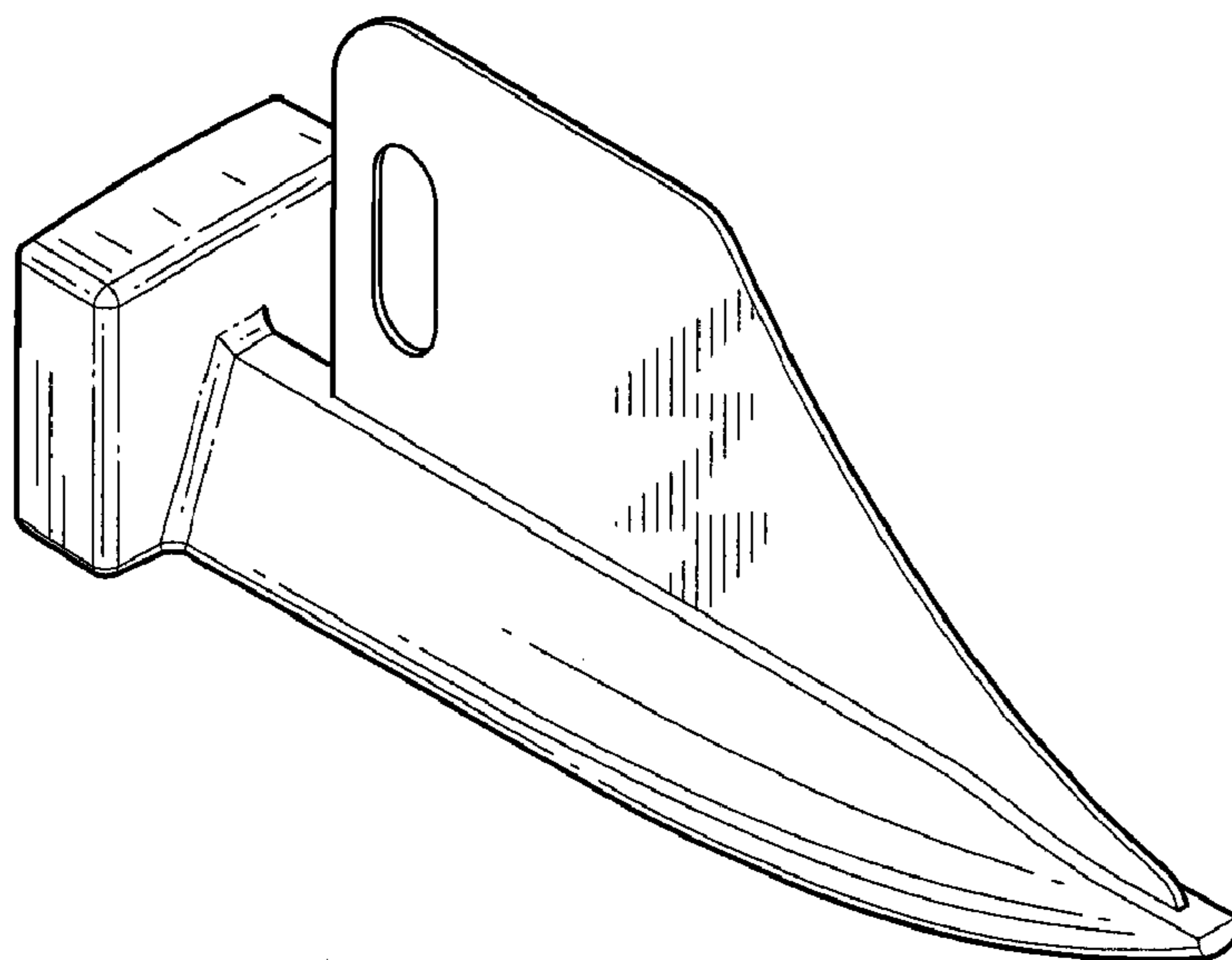

FIG. 2

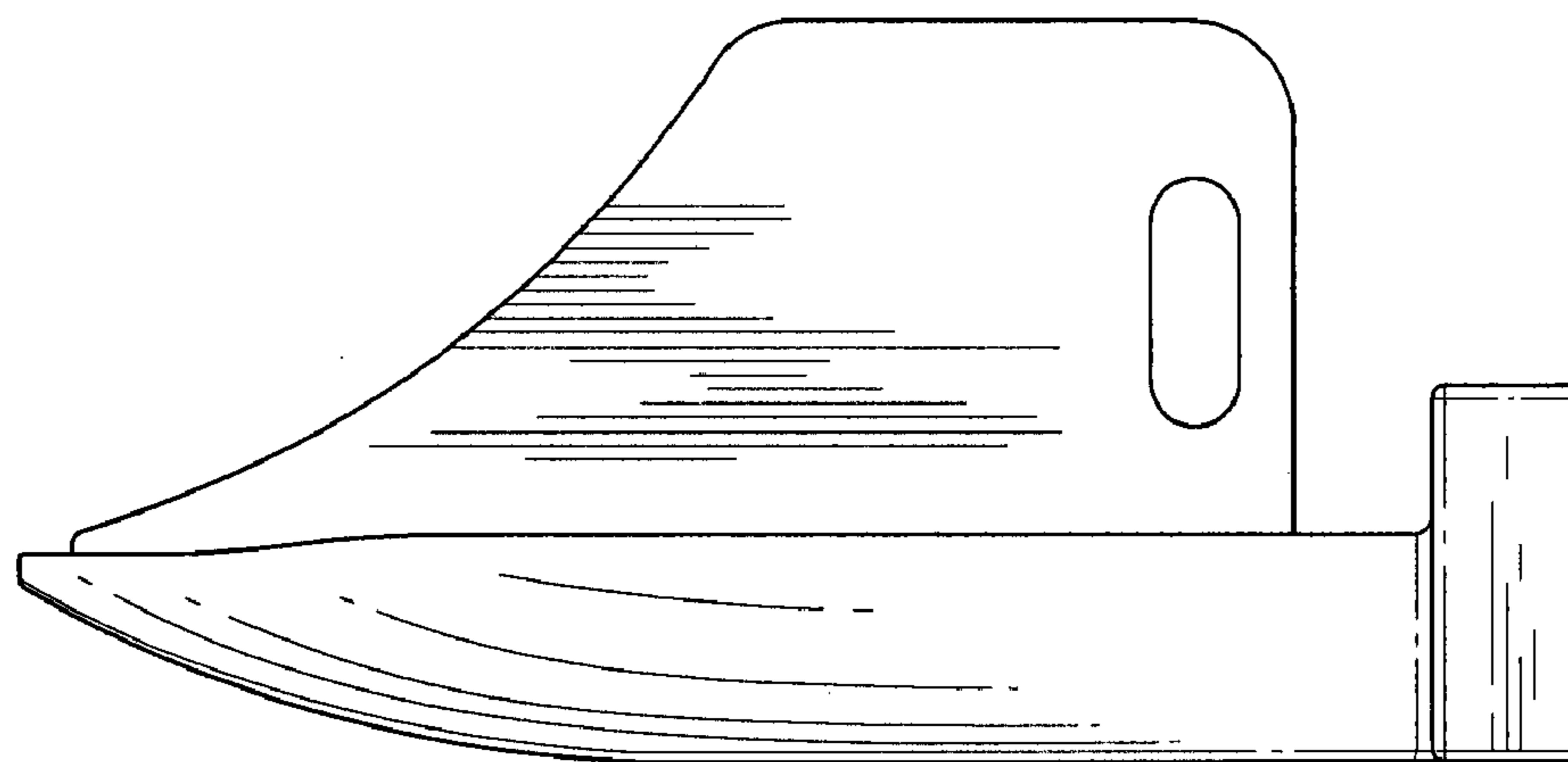

FIG. 3

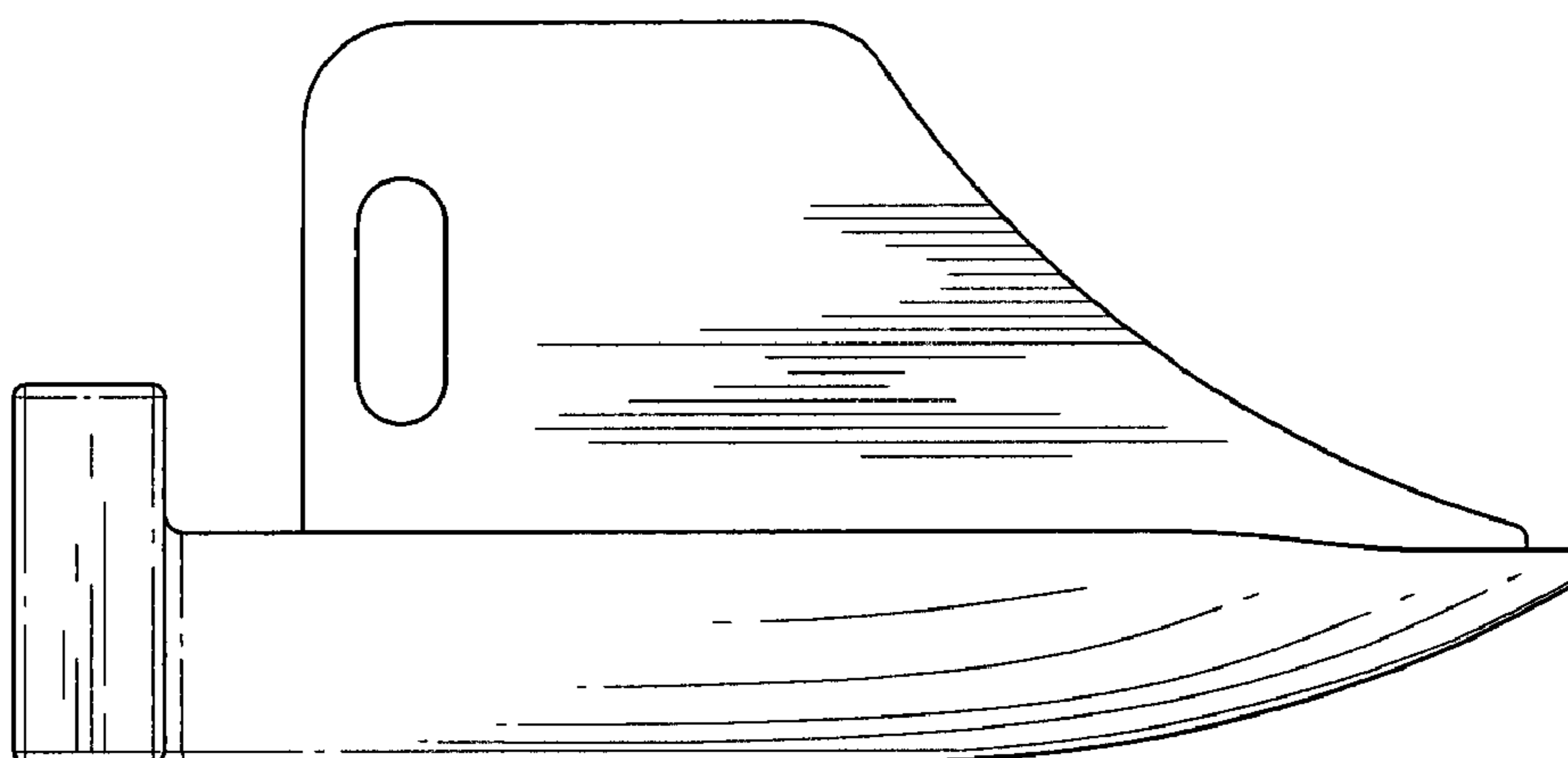

FIG. 4

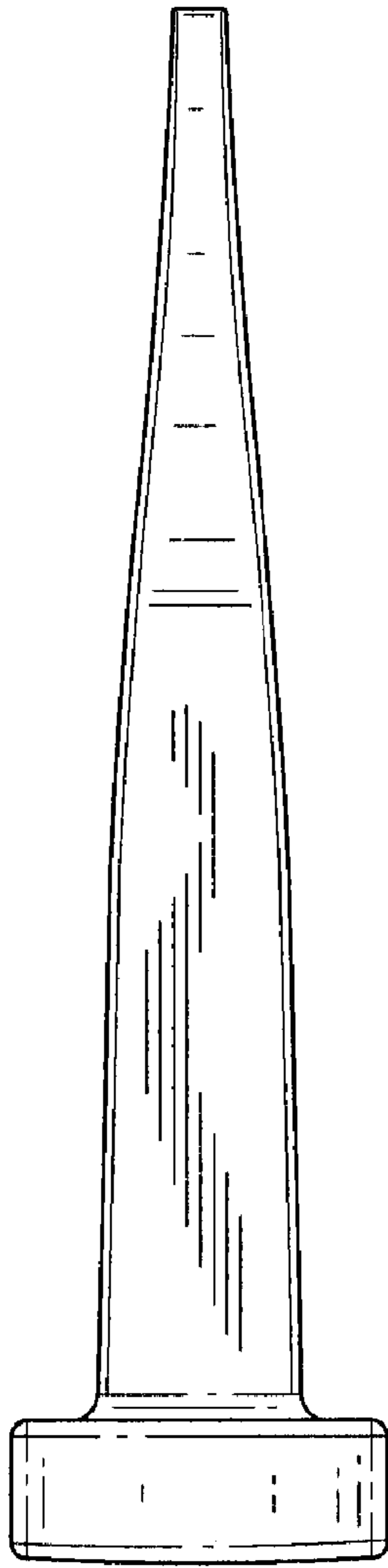

FIG. 5

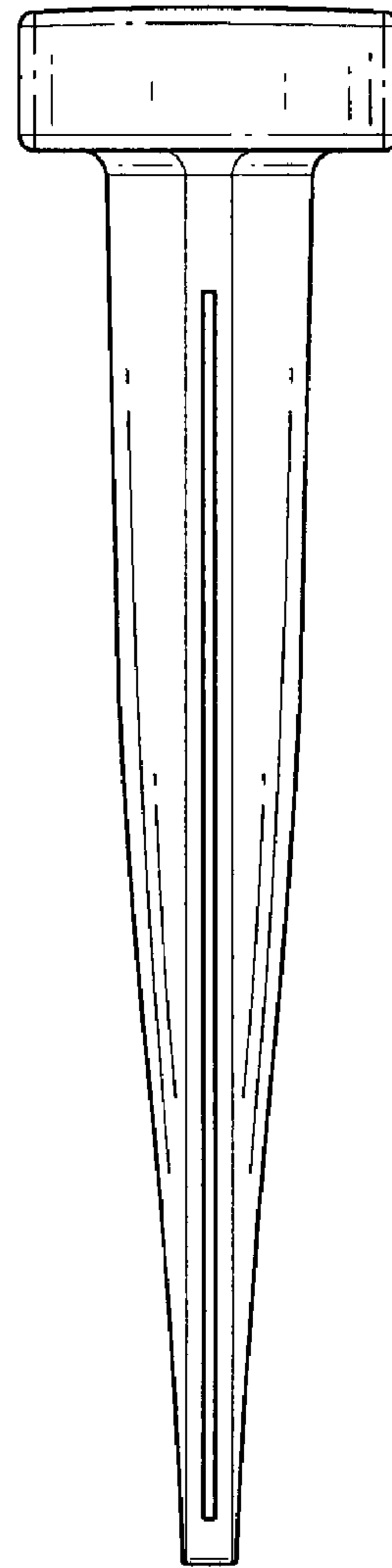

FIG. 6

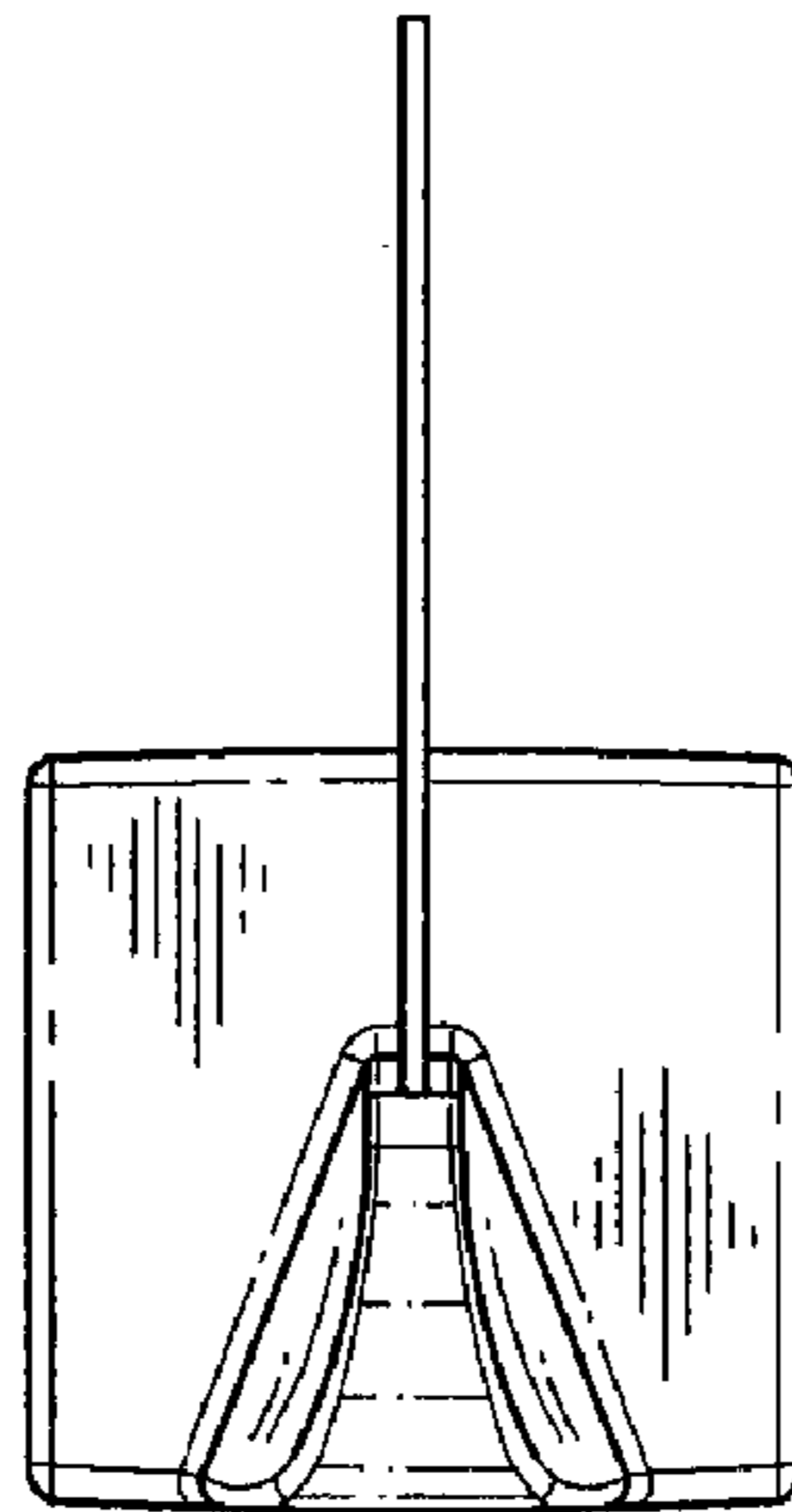

FIG. 7

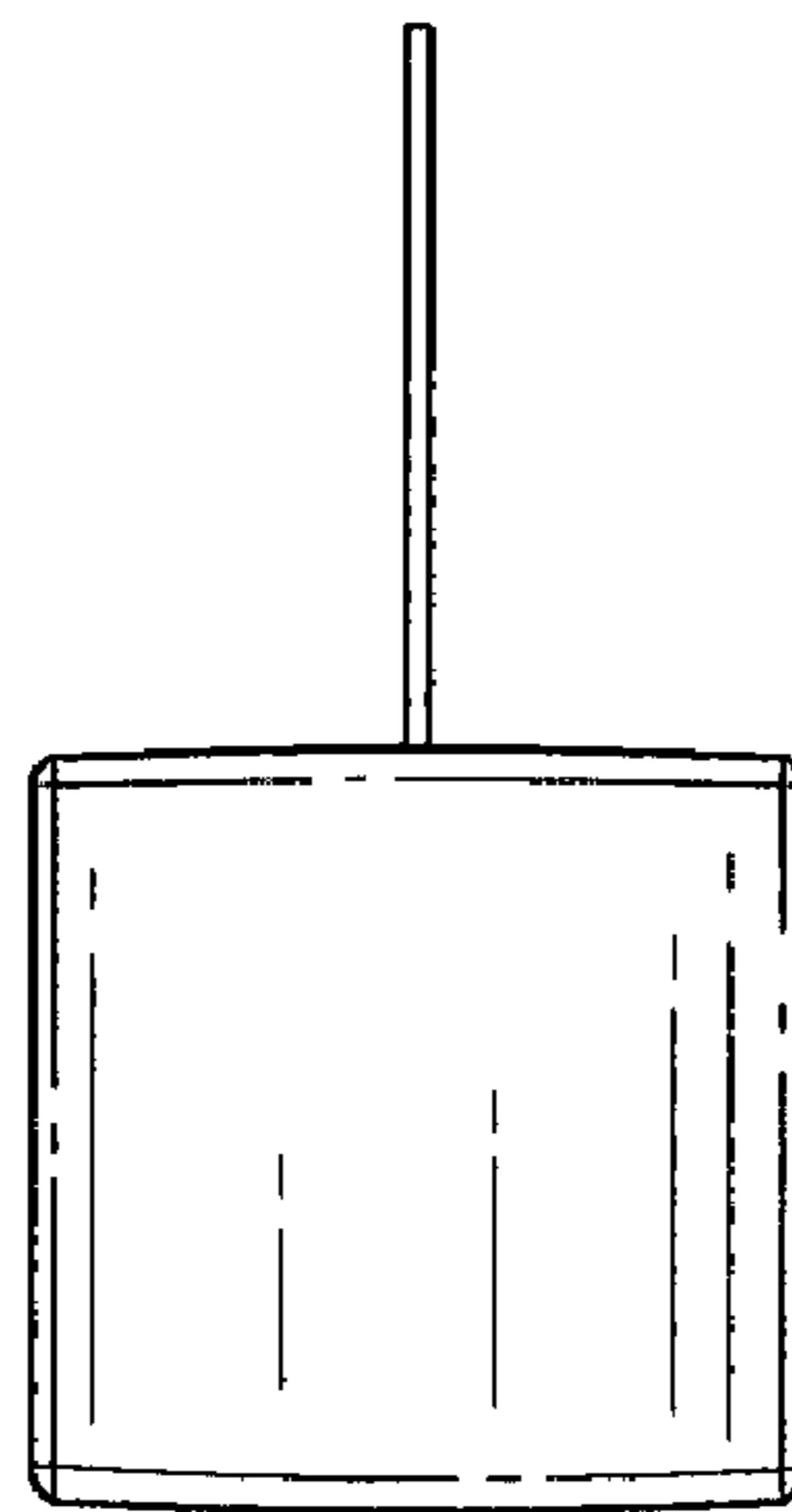

FIG. 8