

US00D597019S

(12) **United States Design Patent**  
**Zarza**

(10) **Patent No.:** **US D597,019 S**  
(45) **Date of Patent:** **\*\* Jul. 28, 2009**

- (54) **STORAGE BOX FOR A VEHICLE**
- (75) Inventor: **Steve Zarza**, Sturgis, MI (US)
- (73) Assignee: **Owens Products, Inc.**, Sturgis, MI (US)
- (\*\*) Term: **14 Years**
- (21) Appl. No.: **29/289,670**
- (22) Filed: **Jul. 27, 2007**

- (51) **LOC (9) Cl.** ..... **12-16**
- (52) **U.S. Cl.** ..... **D12/414.1**
- (58) **Field of Classification Search** ..... D12/106,  
D12/102, 203, 414.1; D25/126-129, 136,  
D25/123, 62, 69; 280/163, 164.1, 166, 169,  
280/607, 164.2, 165; 52/846, 630; 220/1.5,  
220/210, 200; 296/37.6; 292/216, 26; 312/348.3  
See application file for complete search history.

(56) **References Cited**

**U.S. PATENT DOCUMENTS**

D403,654	S *	1/1999	Houry	.....	D12/414.1
6,502,868	B1 *	1/2003	Laspa et al.	.....	292/26
D488,428	S *	4/2004	Greene	.....	D12/414.1
D535,936	S *	1/2007	Greene	.....	D12/414.1
D540,737	S *	4/2007	Bogard	.....	D12/414.1
7,416,228	B2 *	8/2008	Pfitzinger et al.	.....	292/216
2001/0032848	A1 *	10/2001	Jones et al.	.....	220/200
2004/0020952	A1 *	2/2004	Schomaker	.....	224/404
2004/0080248	A1 *	4/2004	Klusmeier	.....	312/348.3
2005/0052033	A1 *	3/2005	Pfitzinger et al.	.....	292/216
2006/0076793	A1 *	4/2006	Schwalie et al.	.....	296/37.6
2007/0039957	A1 *	2/2007	Shulz et al.	.....	220/210

\* cited by examiner

*Primary Examiner*—Caron Veynar  
*Assistant Examiner*—George D Kirschbaum  
(74) *Attorney, Agent, or Firm*—Flynn, Thiel, Boutell & Tanis, P.C.

(57) **CLAIM**

The ornamental design for a storage box for a vehicle, as shown and described.

**DESCRIPTION**

FIG. 1 is a front perspective view of a first embodiment of a storage box for a vehicle embodying my new design;

FIG. 2 is a right side view thereof;

FIG. 3 is a left side view thereof;

FIG. 4 is a front view thereof;

FIG. 5 is a rear view thereof;

FIG. 6 is a top view thereof;

FIG. 7 is a bottom view thereof;

FIG. 8 is a front perspective view of a second embodiment;

FIG. 9 is a right side view thereof;

FIG. 10 is a left side view thereof;

FIG. 11 is a front view thereof;

FIG. 12 is a rear view thereof;

FIG. 13 is a top view thereof; and,

FIG. 14 is a bottom view thereof.

The broken lines depict unclaimed environmental subject matter.

**1 Claim, 8 Drawing Sheets**

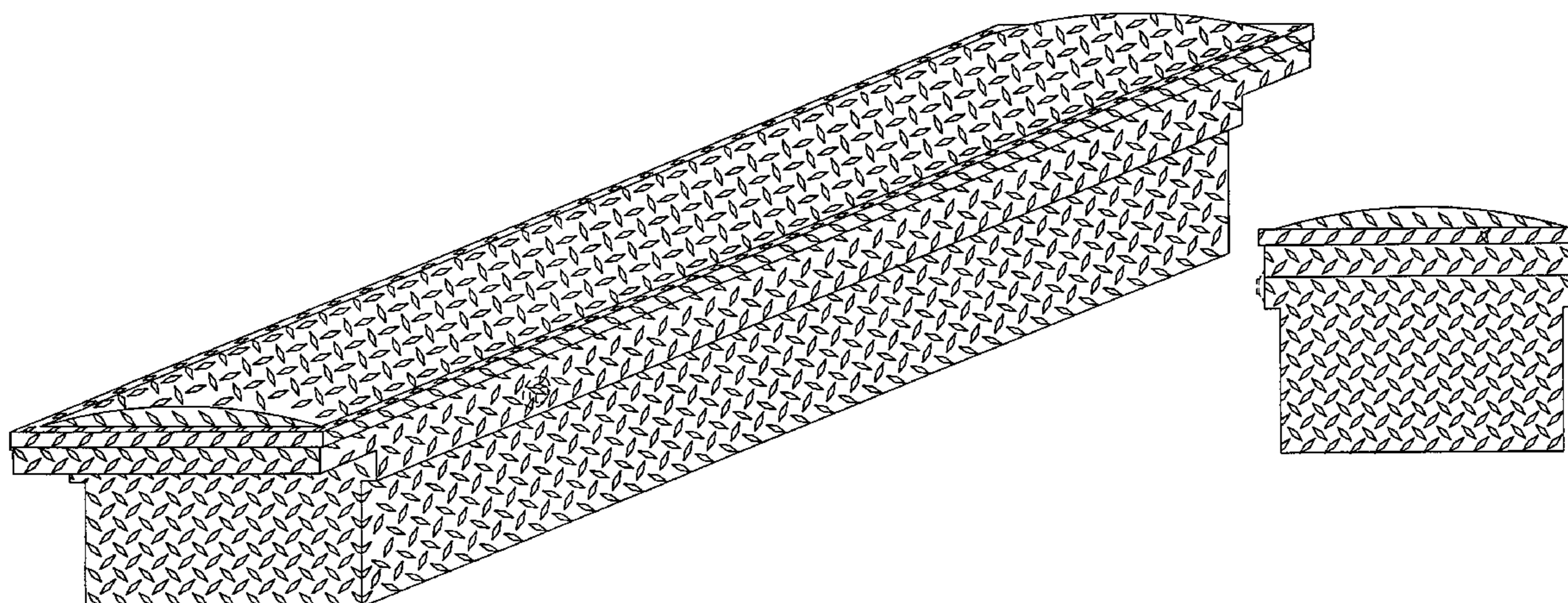

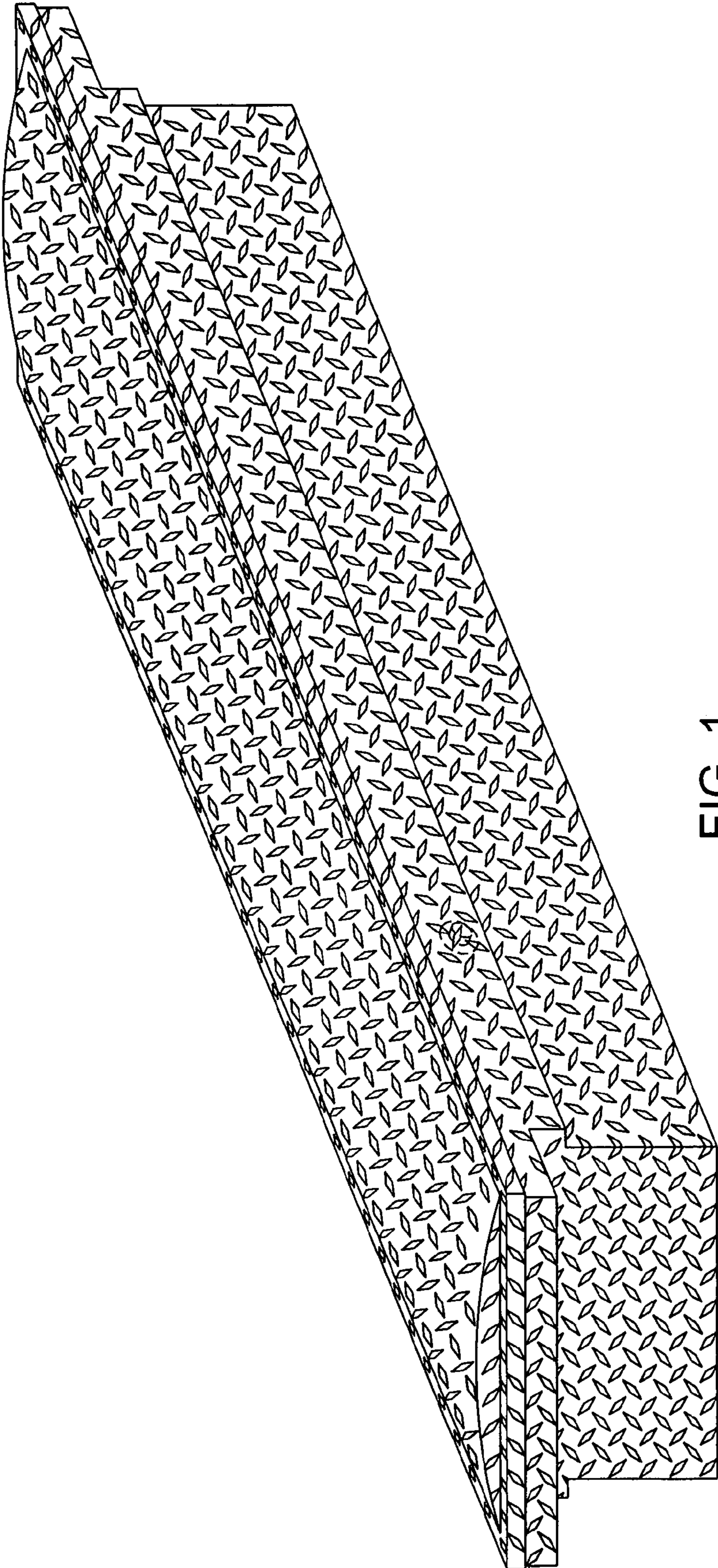

FIG. 1

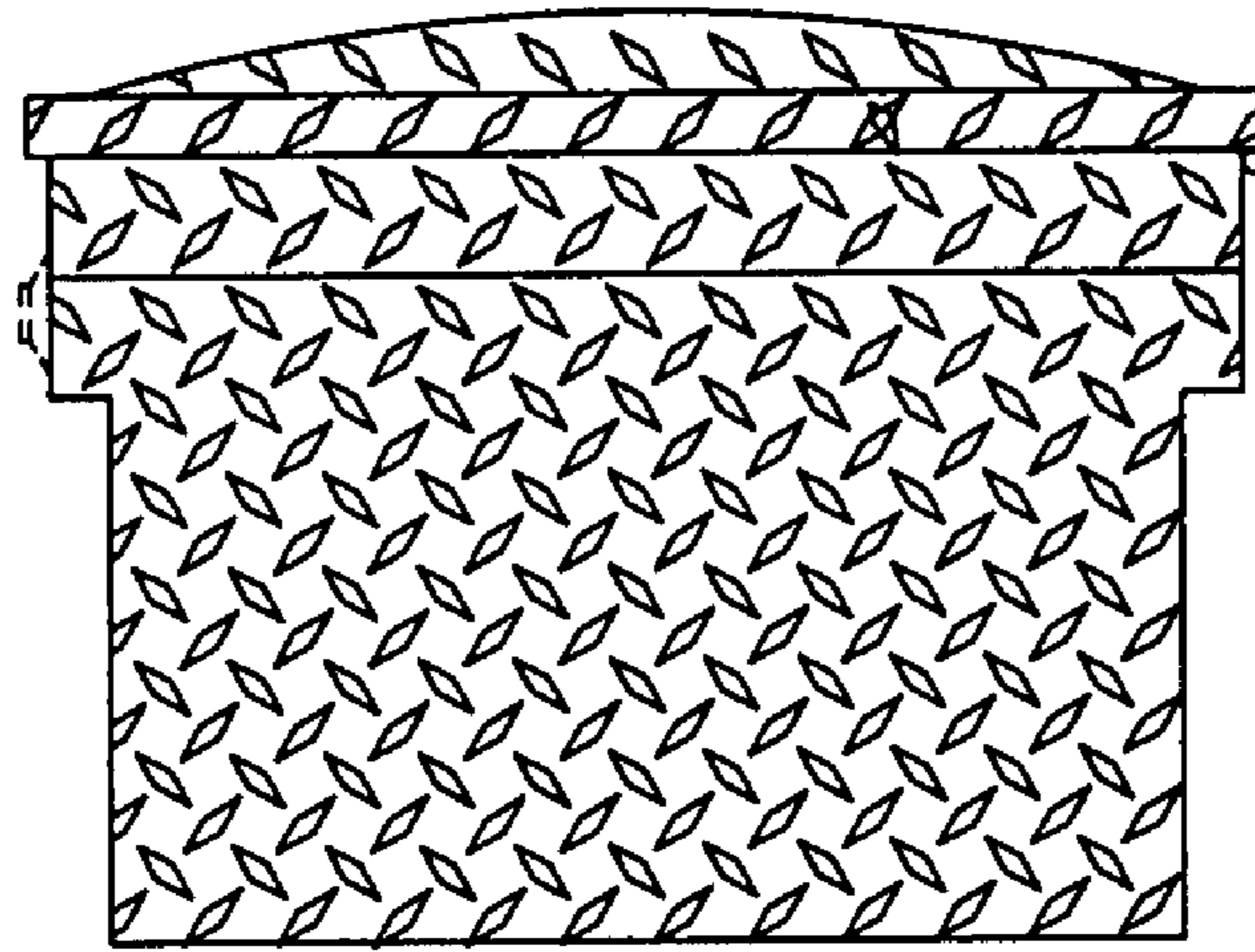

FIG. 2

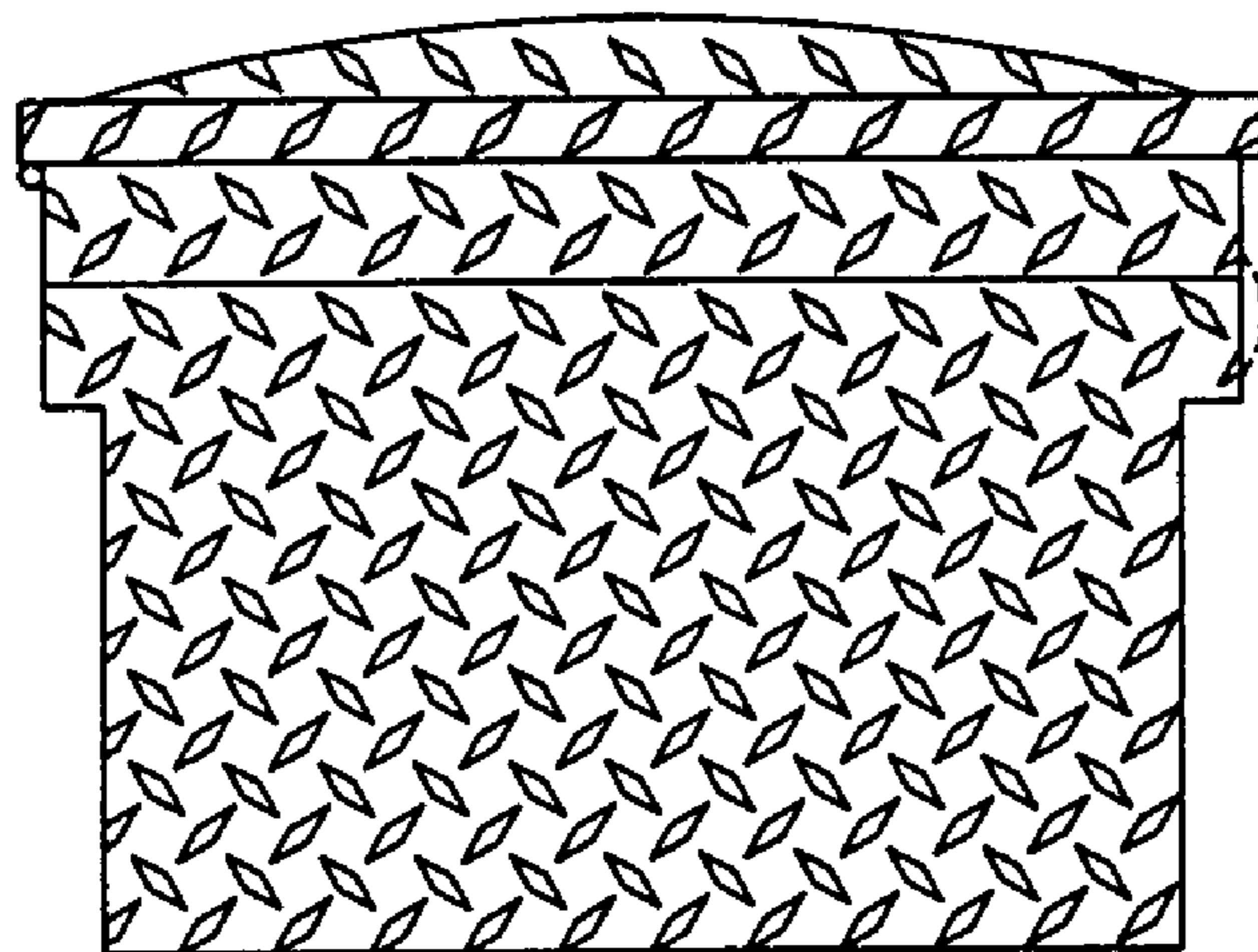

FIG. 3

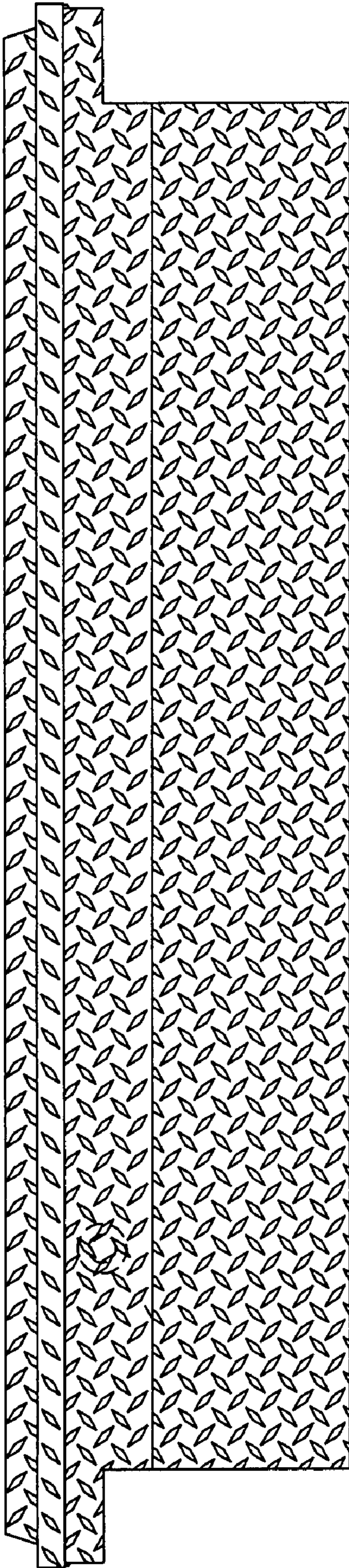

FIG. 4

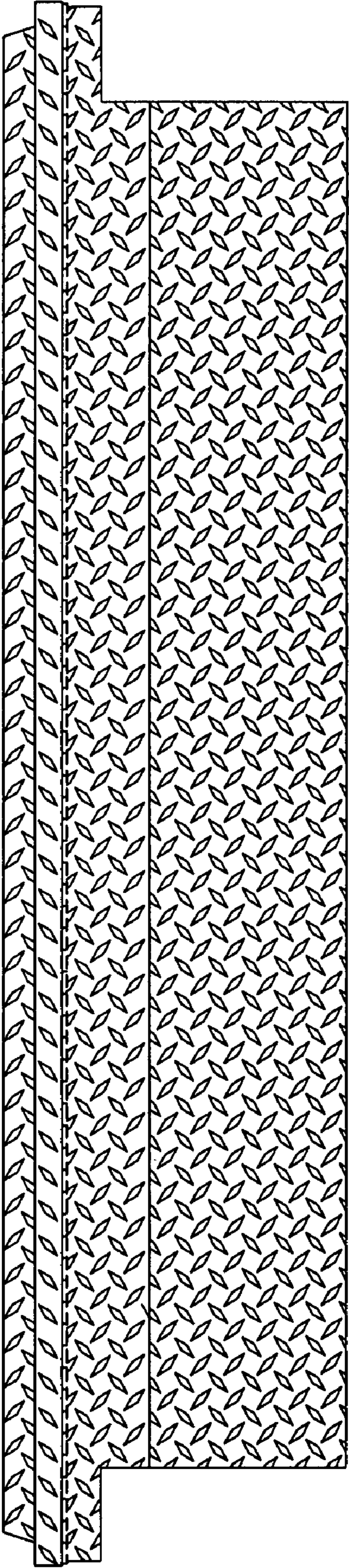

FIG. 5

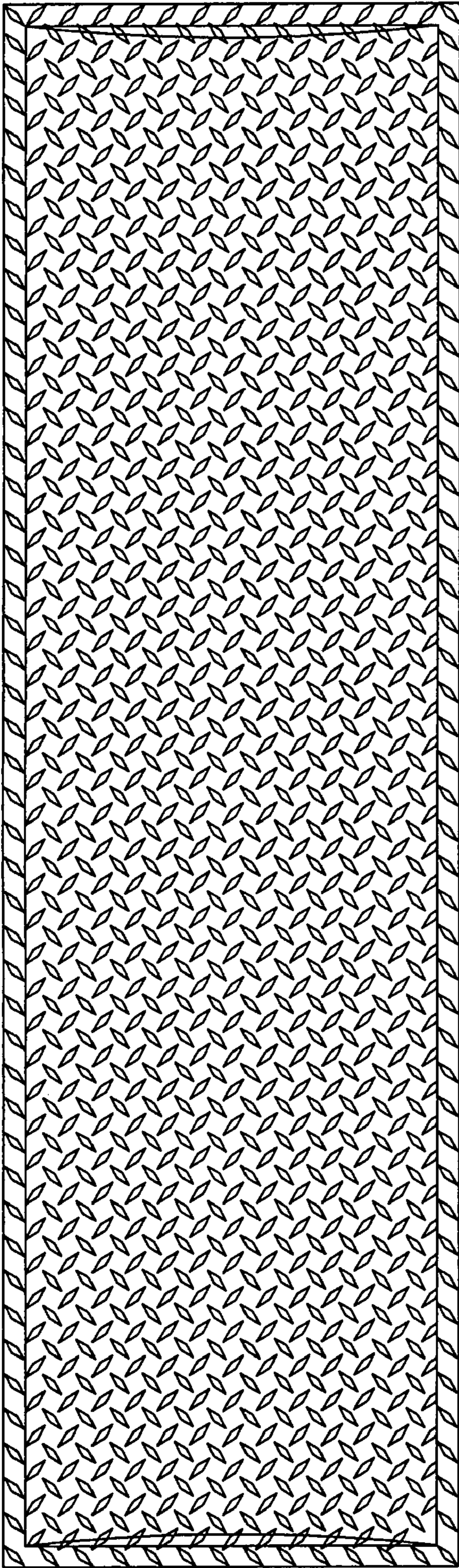

FIG. 6

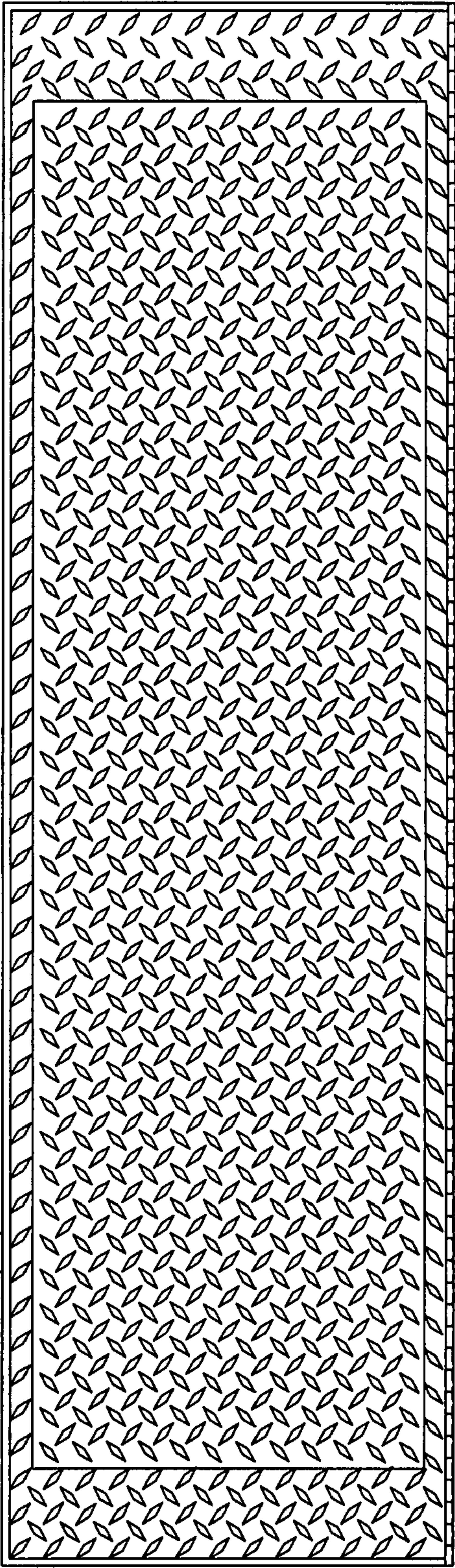

FIG. 7

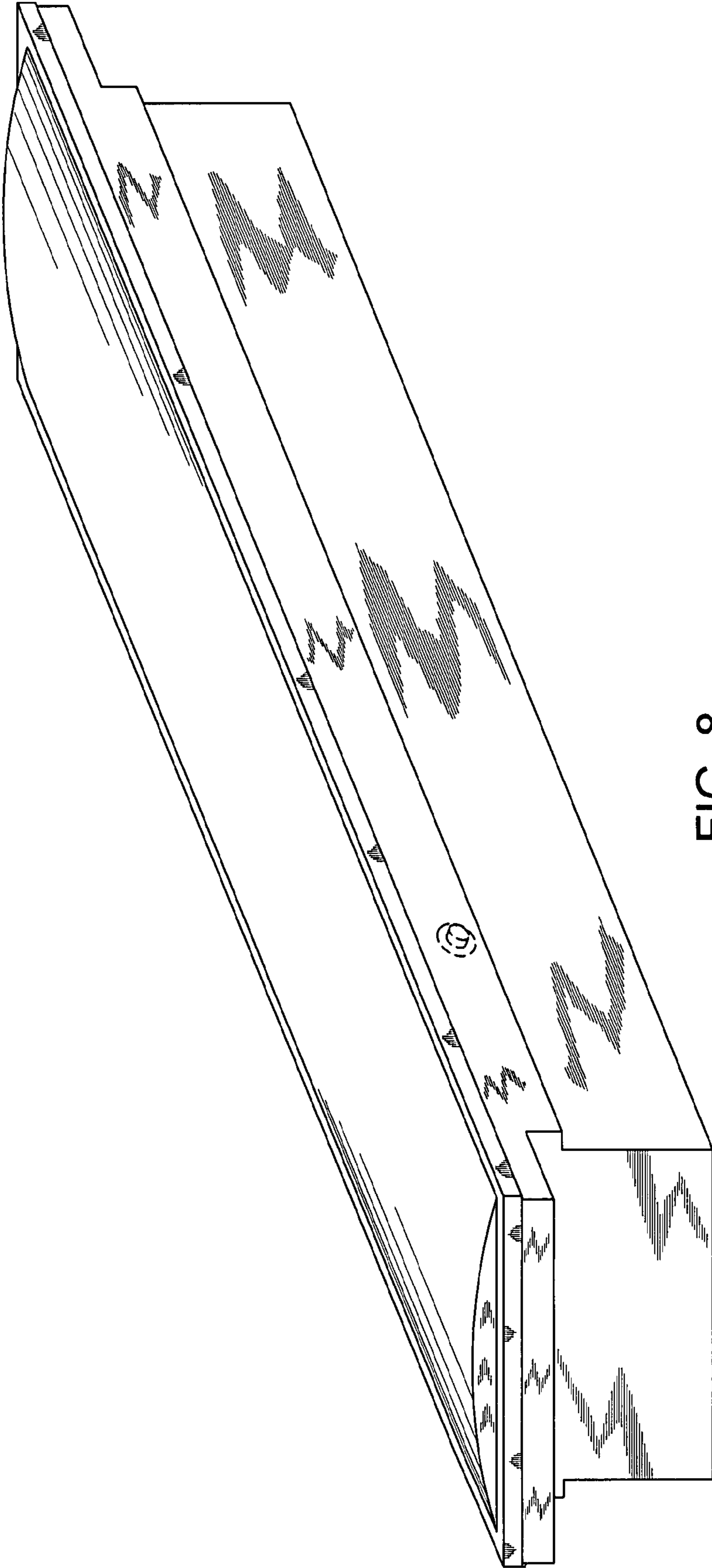

FIG. 8

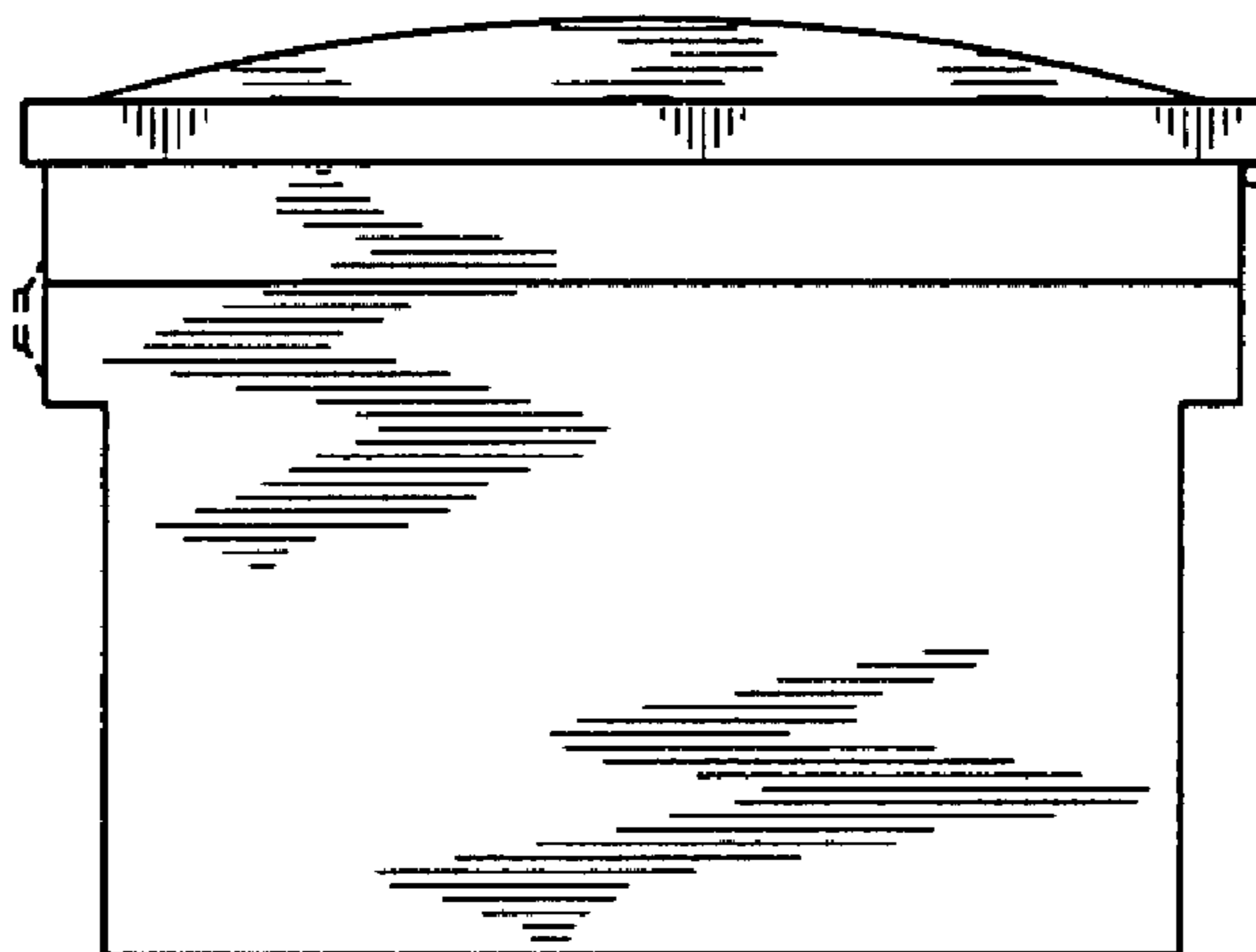

FIG. 9

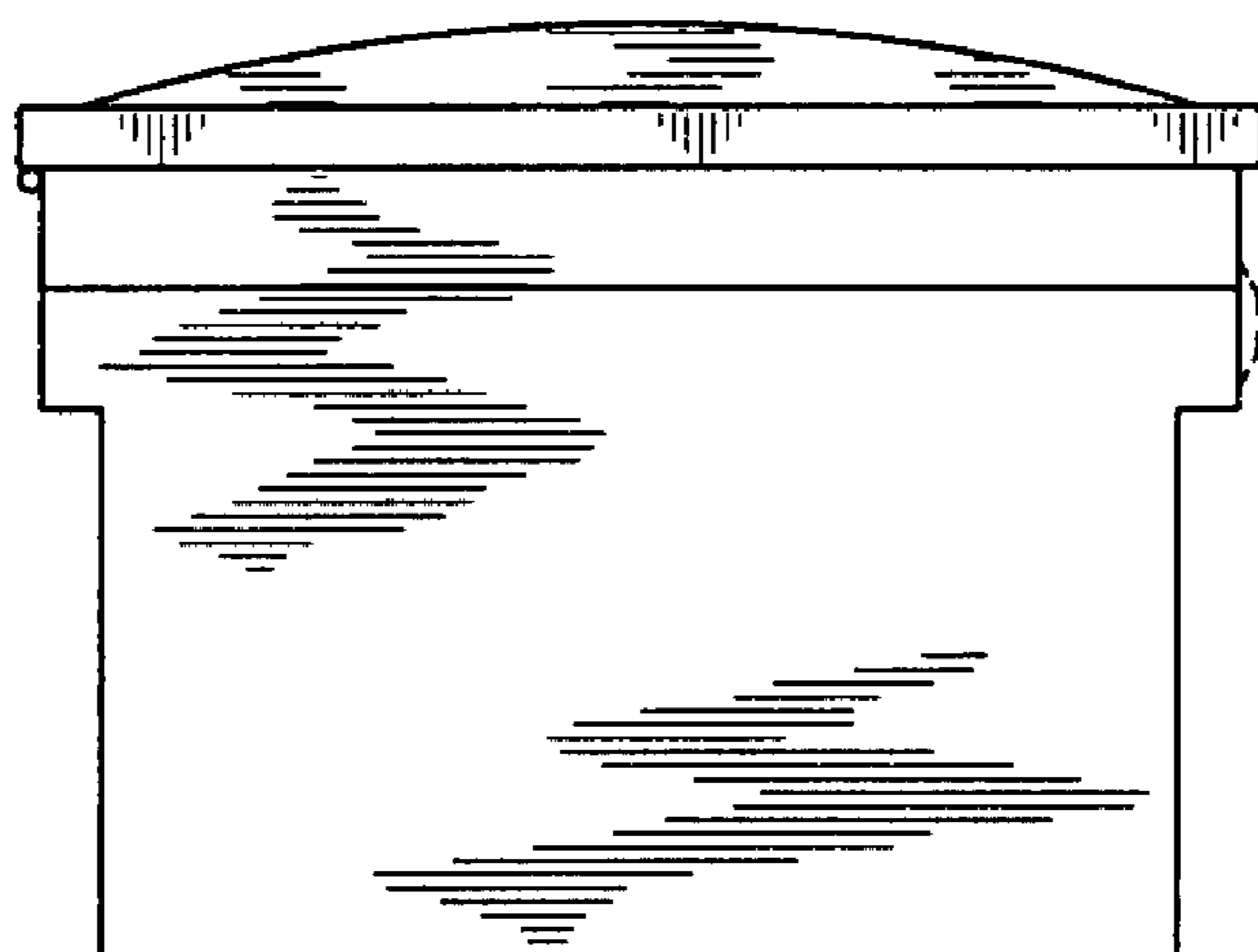

FIG. 10

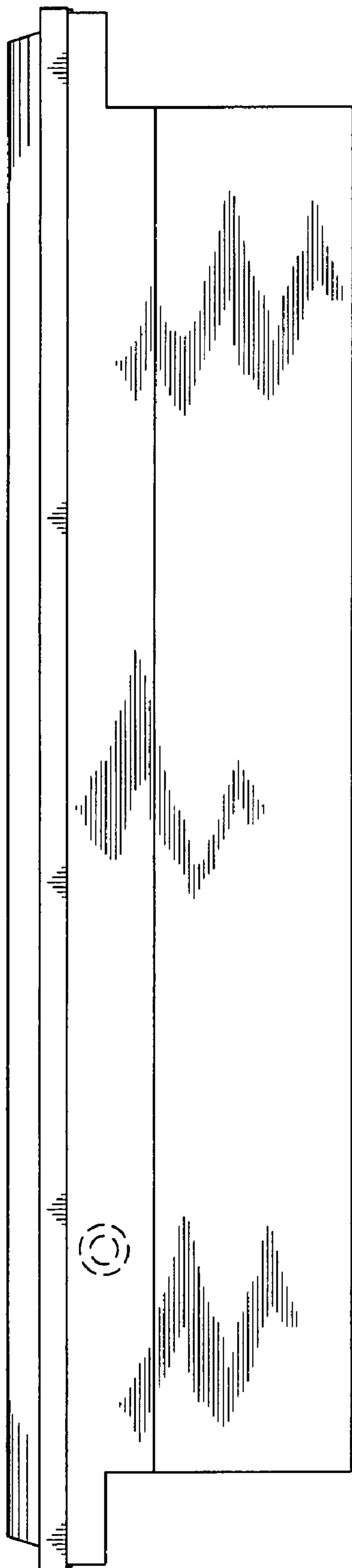

FIG. 11

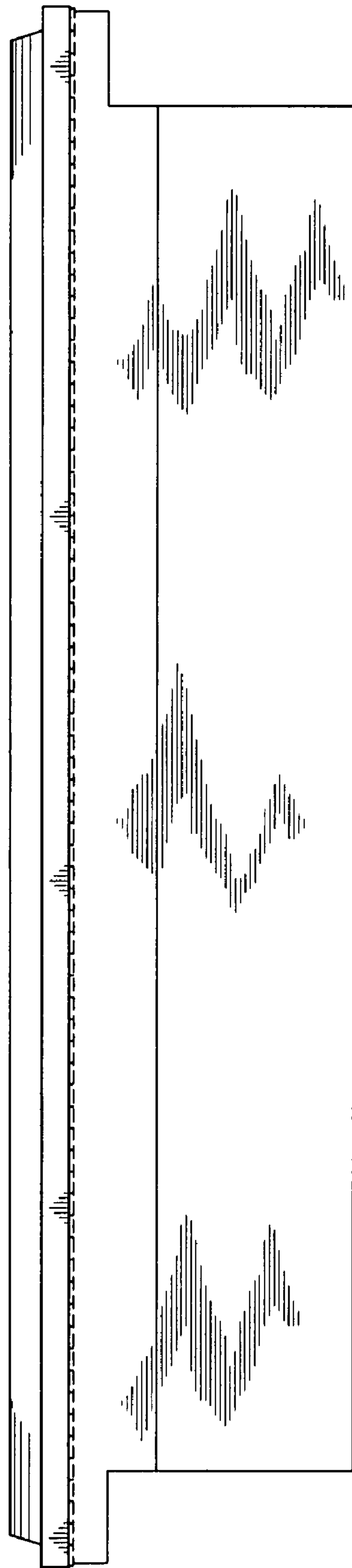

FIG. 12



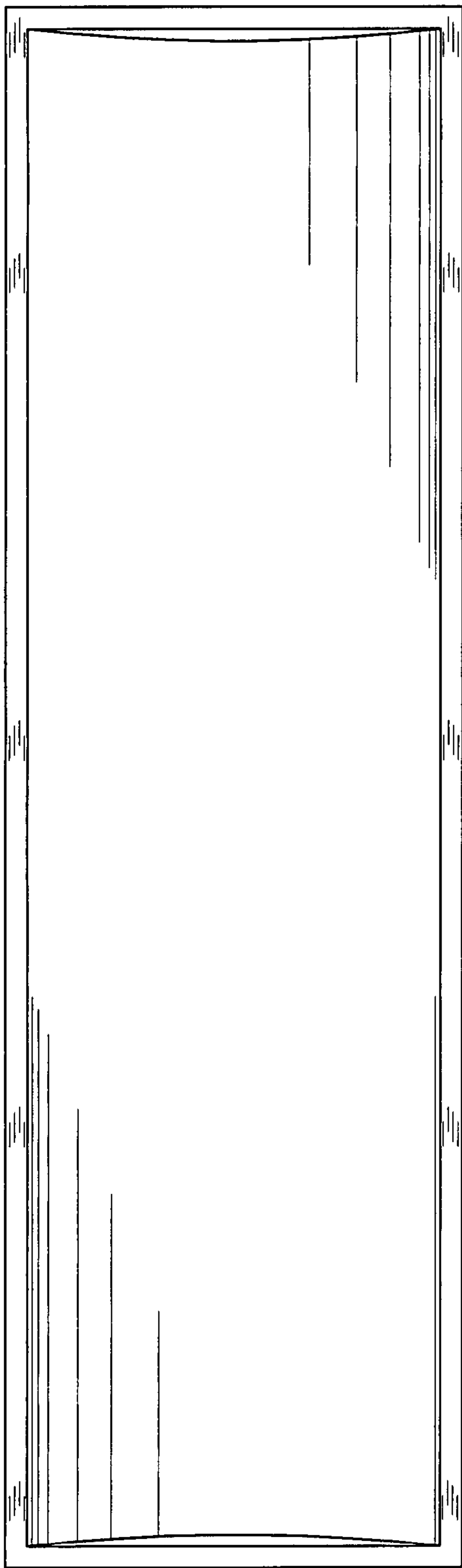

FIG. 13

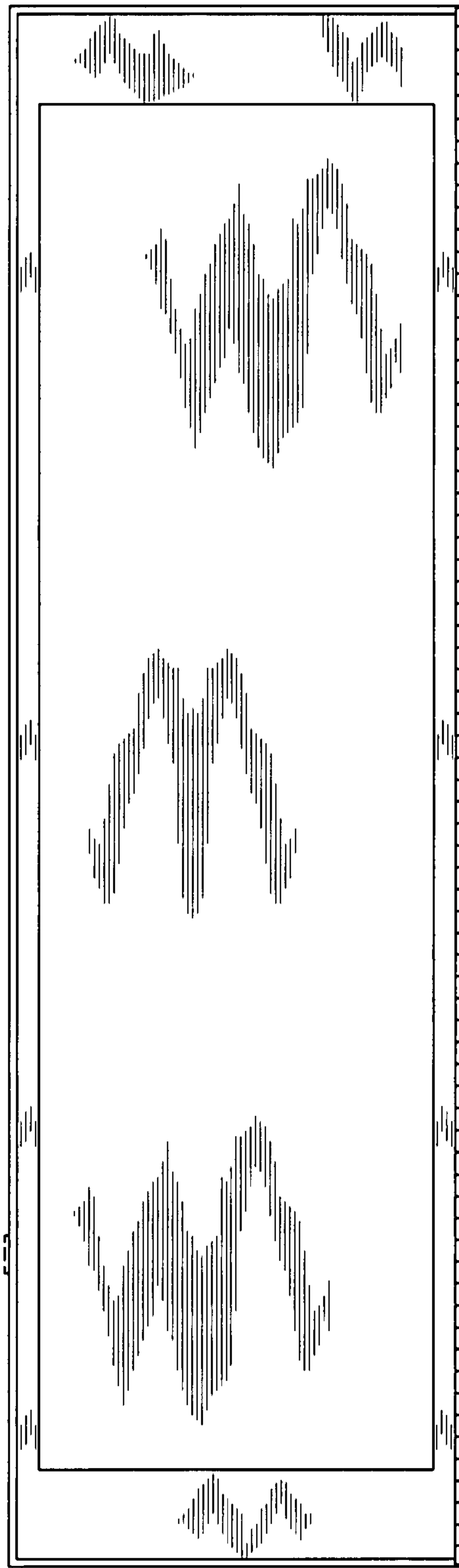

FIG. 14