



US00D596993S

(12) **United States Design Patent**  
**Matthies**

(10) **Patent No.:** **US D596,993 S**  
(45) **Date of Patent:** **\*\* Jul. 28, 2009**

(54) **DETACHABLE MOTORCYCLE TRIKE BODY**

(76) **Inventor:** **Lawayne L. Matthies**, 1888 Mountain Creek Pkwy., Dallas, TX (US) 75211

(\*\*) **Term:** **14 Years**

(21) **Appl. No.:** **29/318,398**

(22) **Filed:** **May 20, 2008**

(51) **LOC (9) Cl.** ..... **12-11**

(52) **U.S. Cl.** ..... **D12/110**

(58) **Field of Classification Search** ..... D12/85,  
D12/107, 110, 112, 184-186, 101-106; 180/16,  
180/209, 210, 215, 217, 219; 280/282, 202-204,  
280/288.4; 296/193.08

See application file for complete search history.

(56) **References Cited**

**U.S. PATENT DOCUMENTS**

D384,626 S *	10/1997	Lehman et al.	.....	D12/181
D386,469 S *	11/1997	Lehman et al.	.....	D12/110
D427,943 S *	7/2000	Lehman et al.	.....	D12/110
D479,160 S *	9/2003	Hyndman et al.	.....	D12/110
D502,893 S *	3/2005	Matthies	.....	D12/110
D512,344 S *	12/2005	Matthies	.....	D12/110

\* cited by examiner

*Primary Examiner*—Robin V. Webster

*Assistant Examiner*—Linda Brooks

(74) *Attorney, Agent, or Firm*—James E. Walton

(57) **CLAIM**

The ornamental design for a detachable motorcycle trike body, as shown and described.

**DESCRIPTION**

FIG. 1 is a perspective view of the detachable motorcycle trike body according to the present design.

FIG. 2 is a front view thereof.

FIG. 3 is a right side view thereof.

FIG. 4 is a left side view thereof.

FIG. 5 is a rear view thereof.

FIG. 6 is a top view thereof.

FIG. 7 is a perspective view of an alternative embodiment of the detachable motorcycle trike body according to the present design.

FIG. 8 is a front view of the detachable motorcycle trike body FIG. 7.

FIG. 9 is a right side view of the detachable motorcycle trike body FIG. 7.

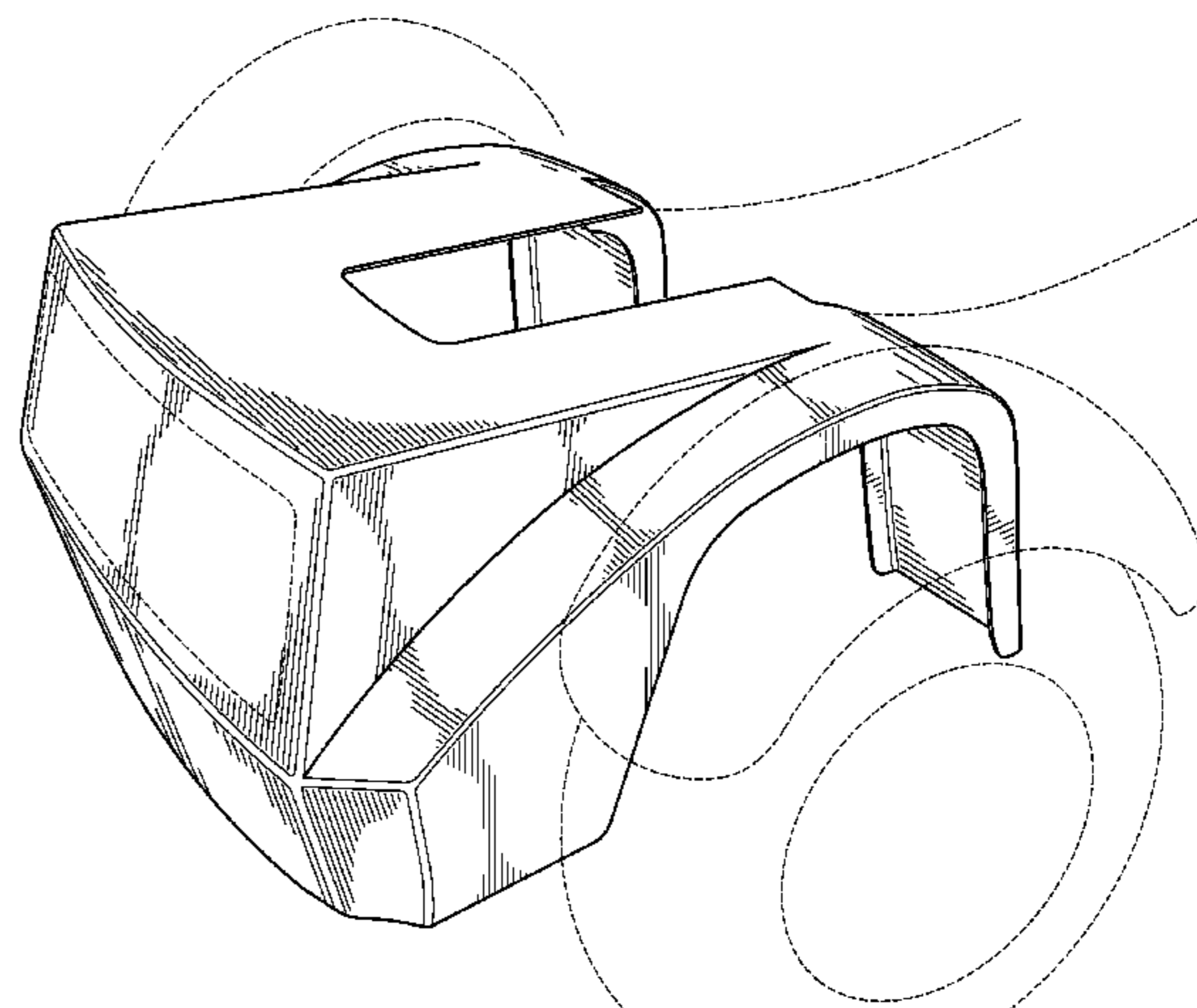
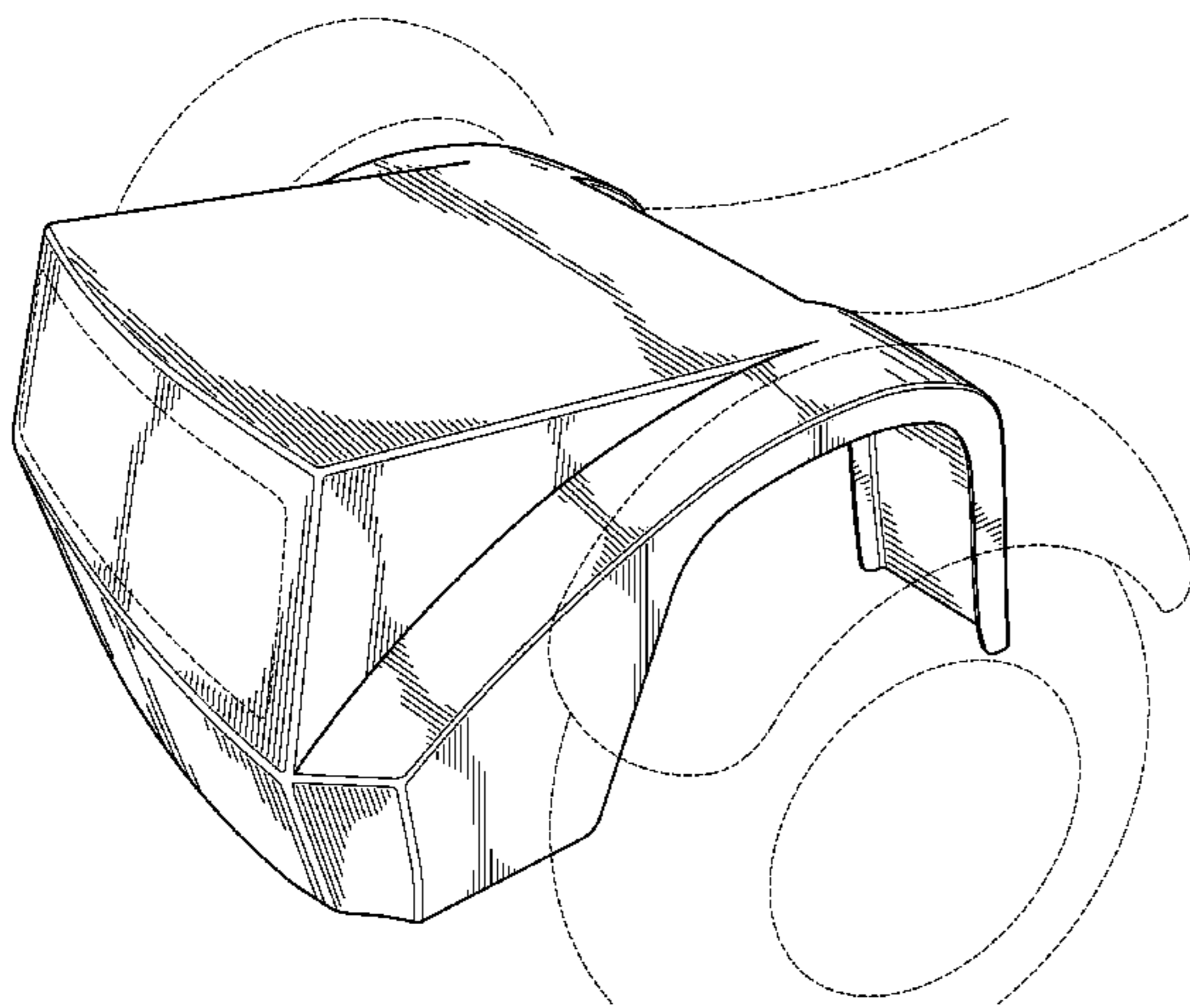
FIG. 10 is a left side view of the detachable motorcycle trike body FIG. 7.

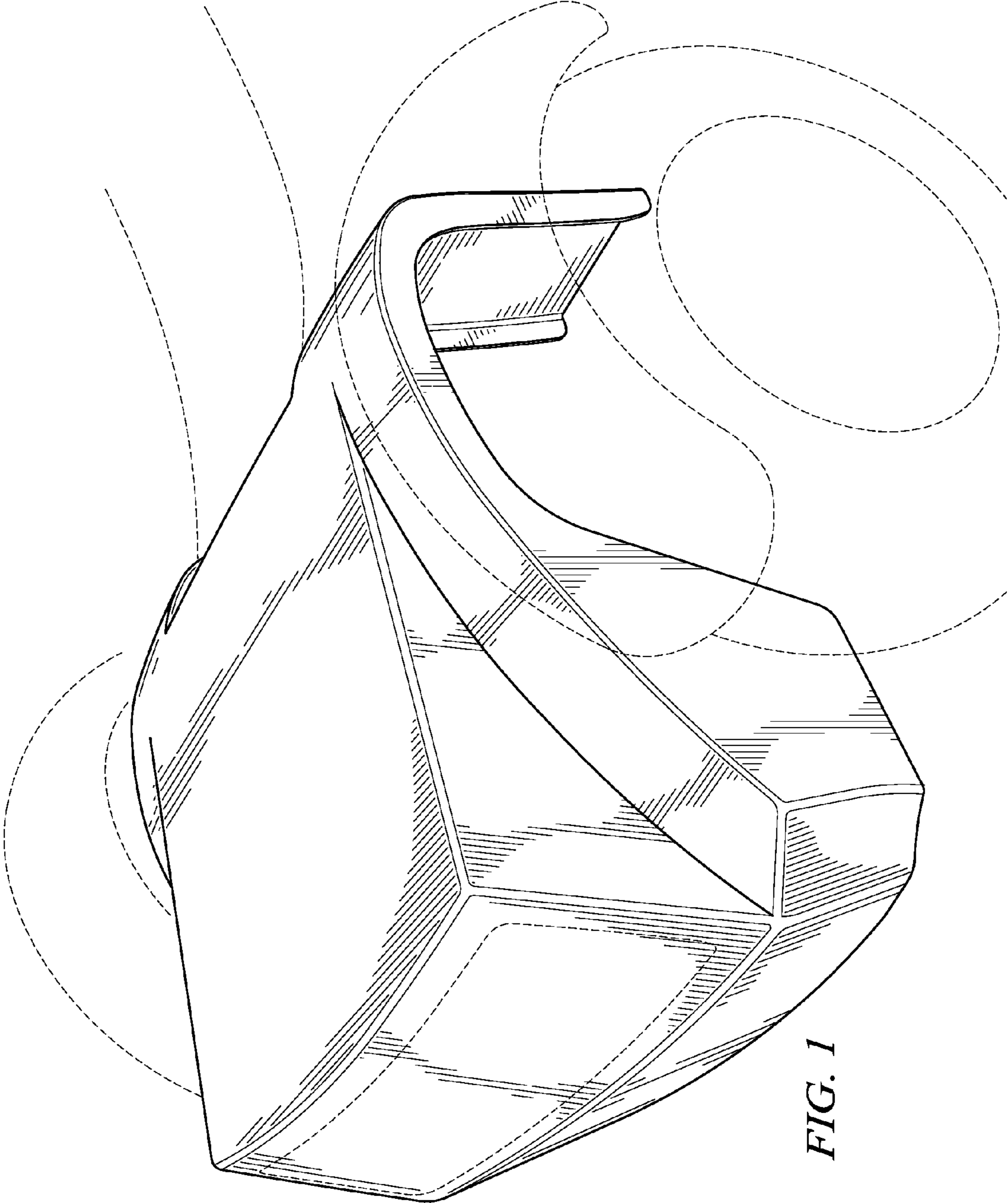
FIG. 11 is a rear view of the detachable motorcycle trike body FIG. 7.

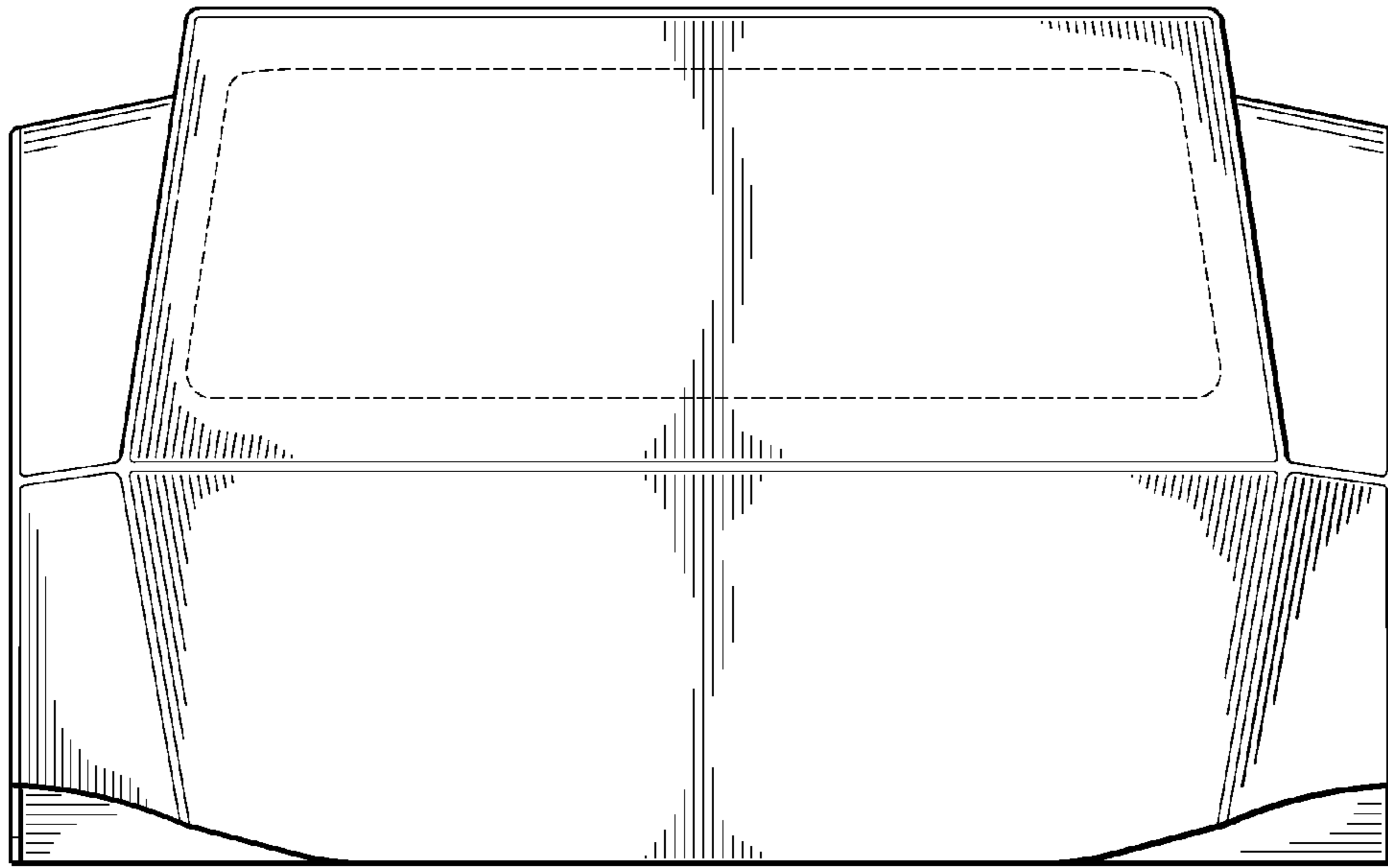
FIG. 12 is a top view of the detachable motorcycle trike body FIG. 7.

The features shown in broken lines in the drawing figures form no part of the claimed design.

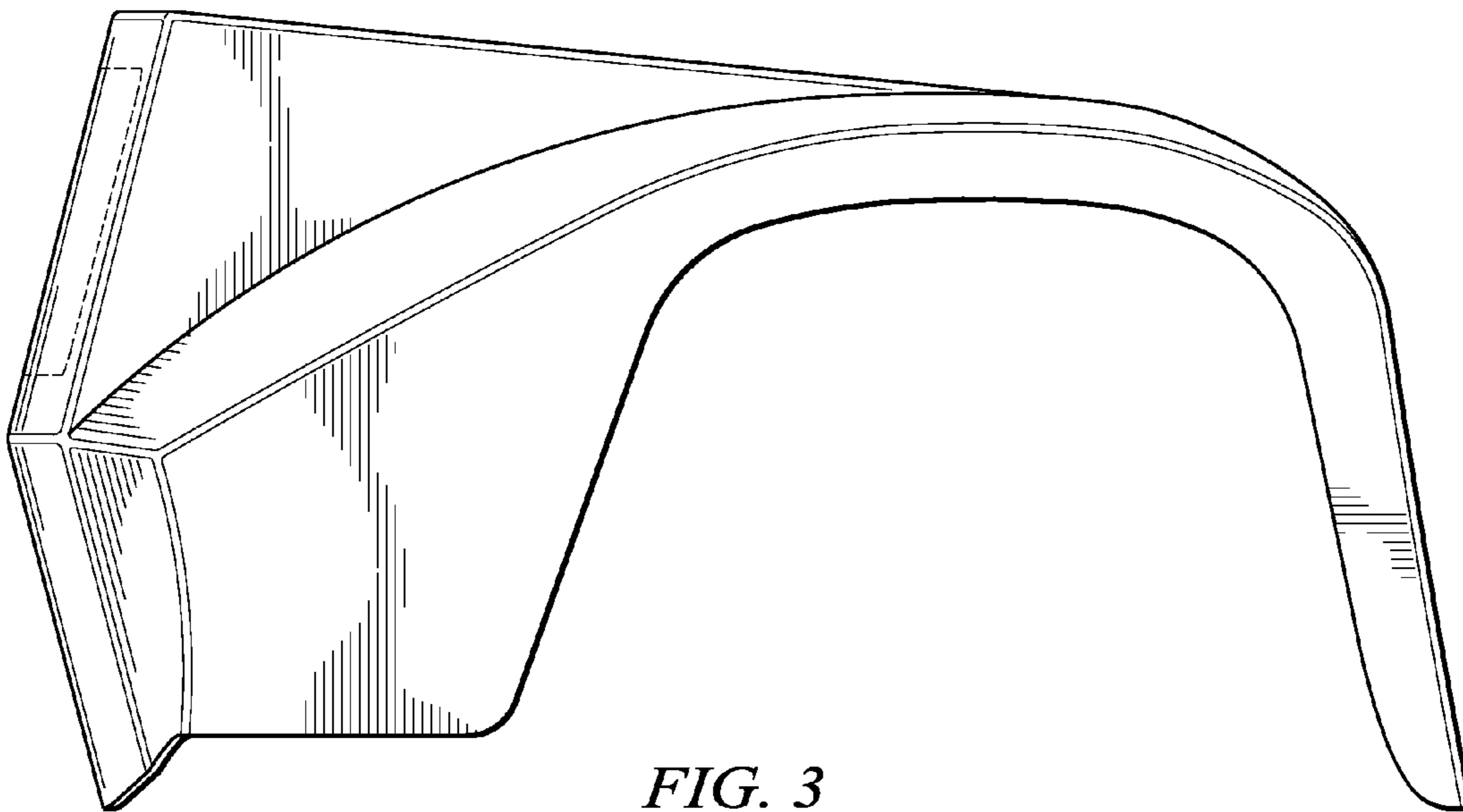
**1 Claim, 8 Drawing Sheets**







*FIG. 2*



*FIG. 3*

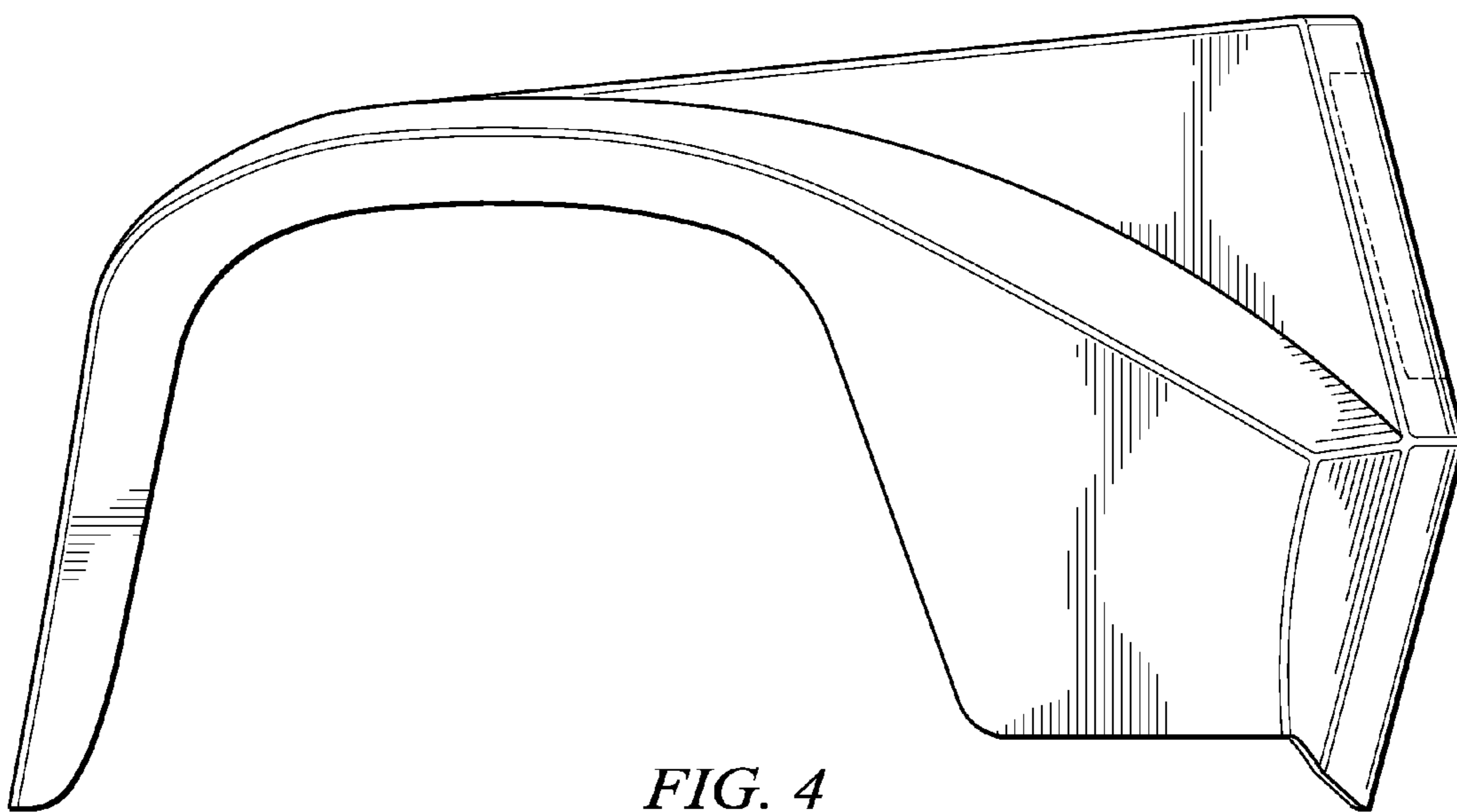


FIG. 4

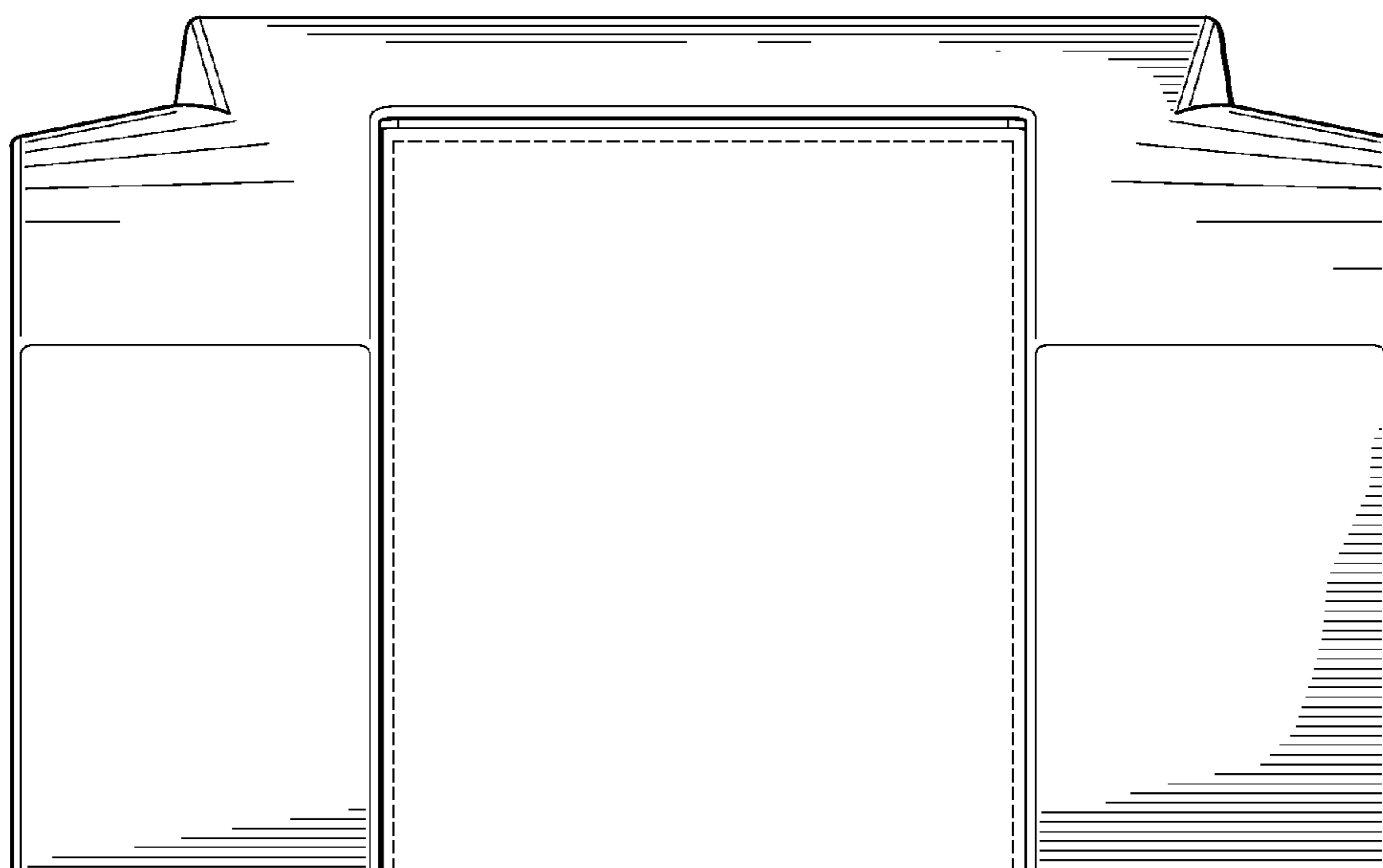


FIG. 5

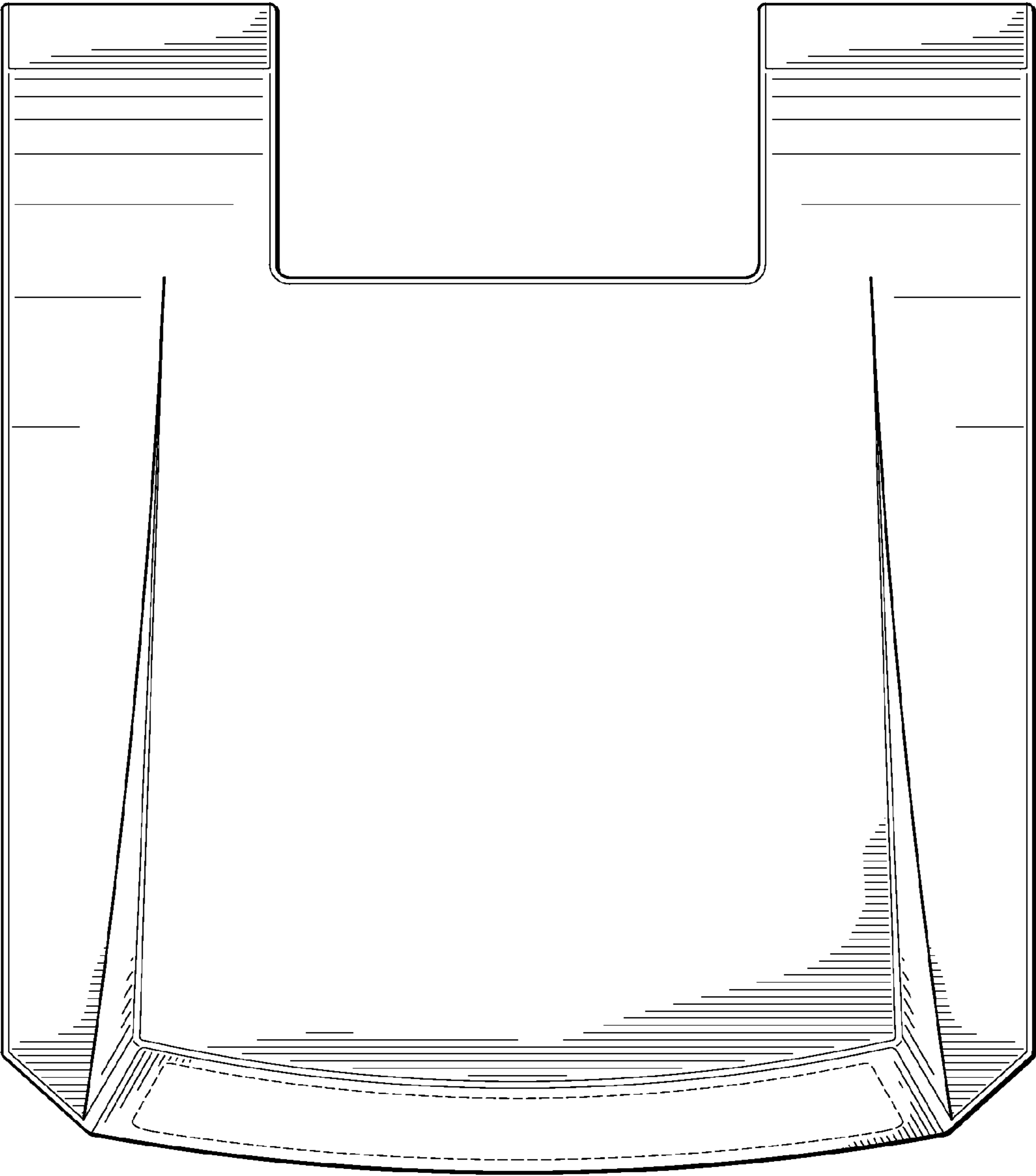
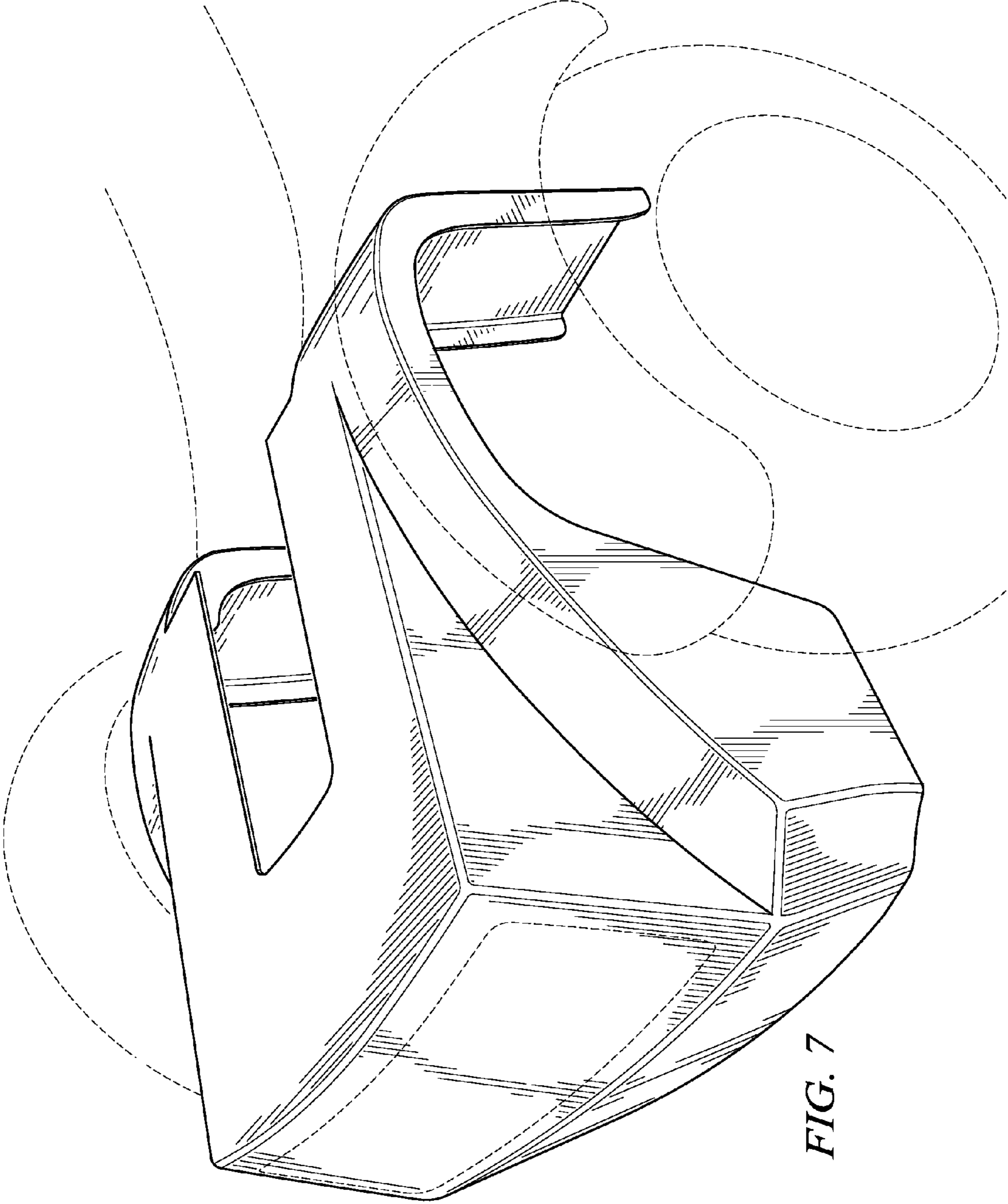
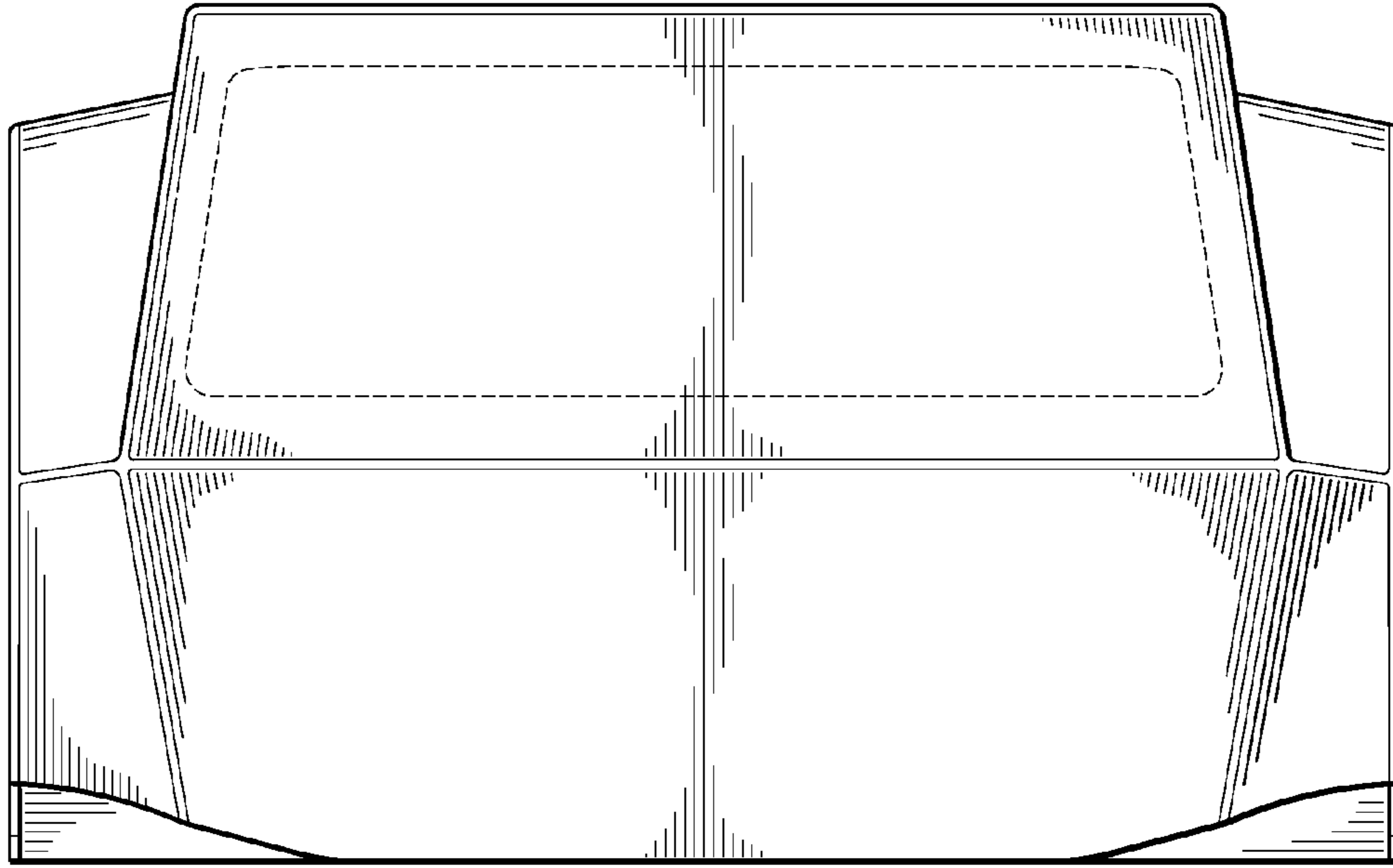
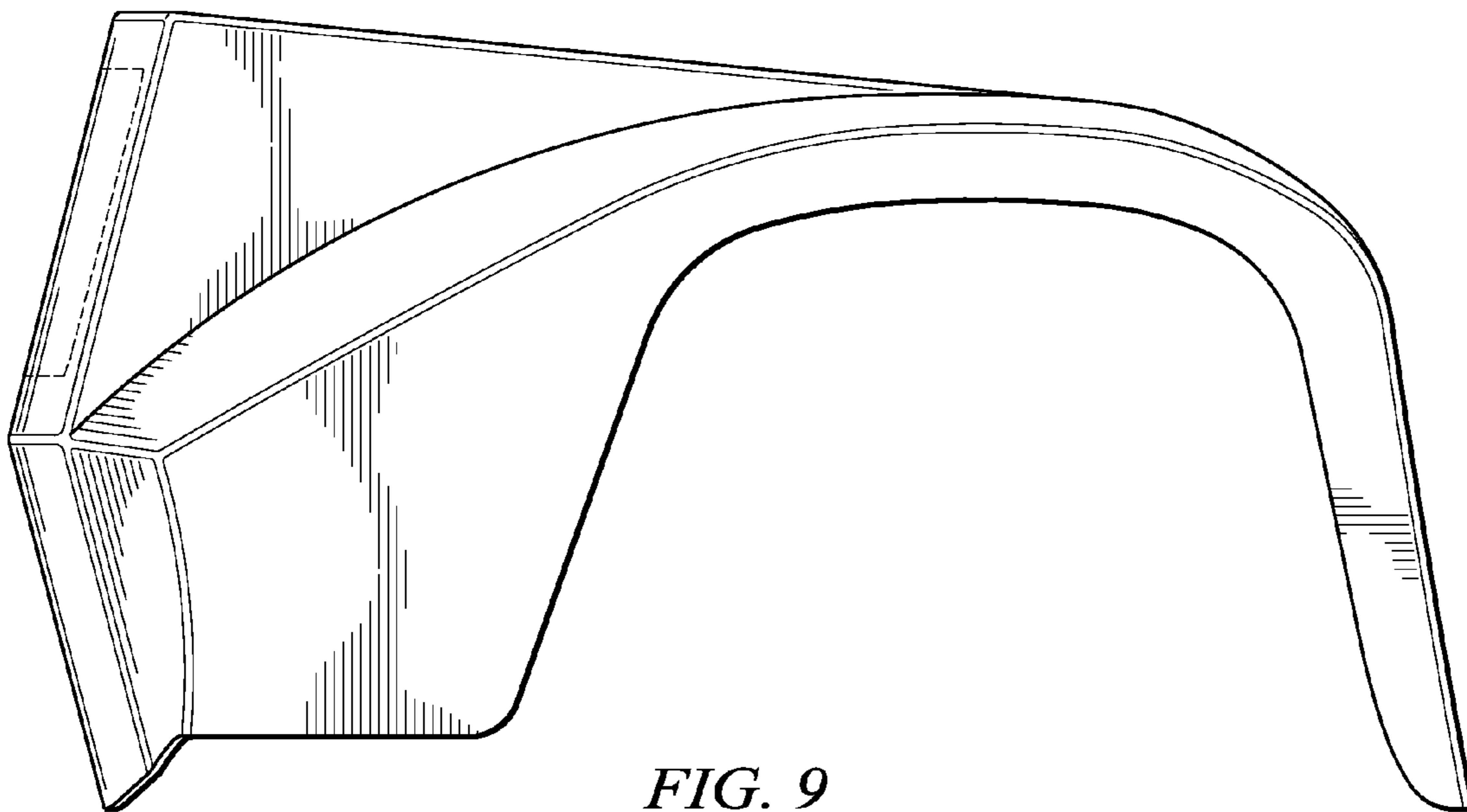


FIG. 6

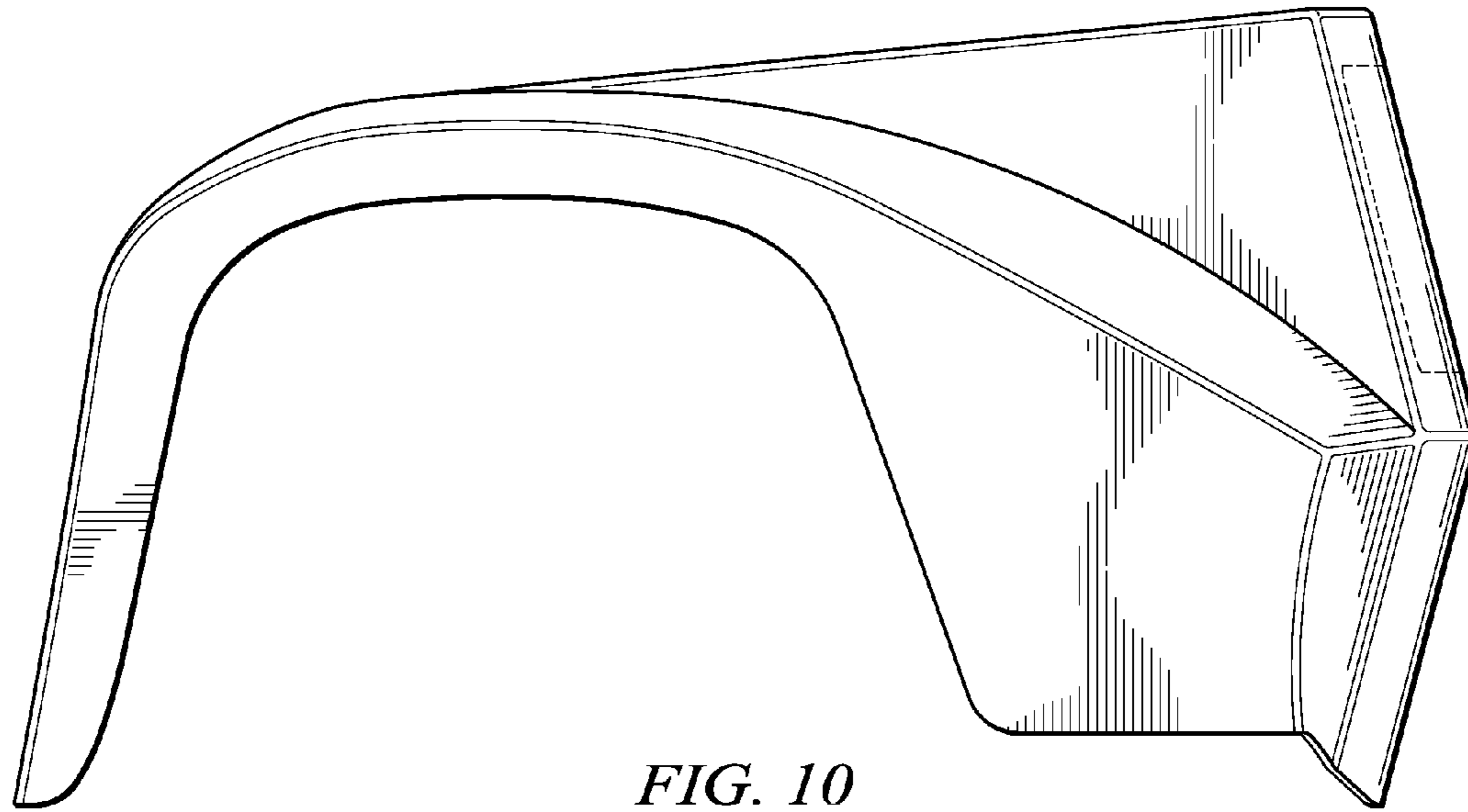




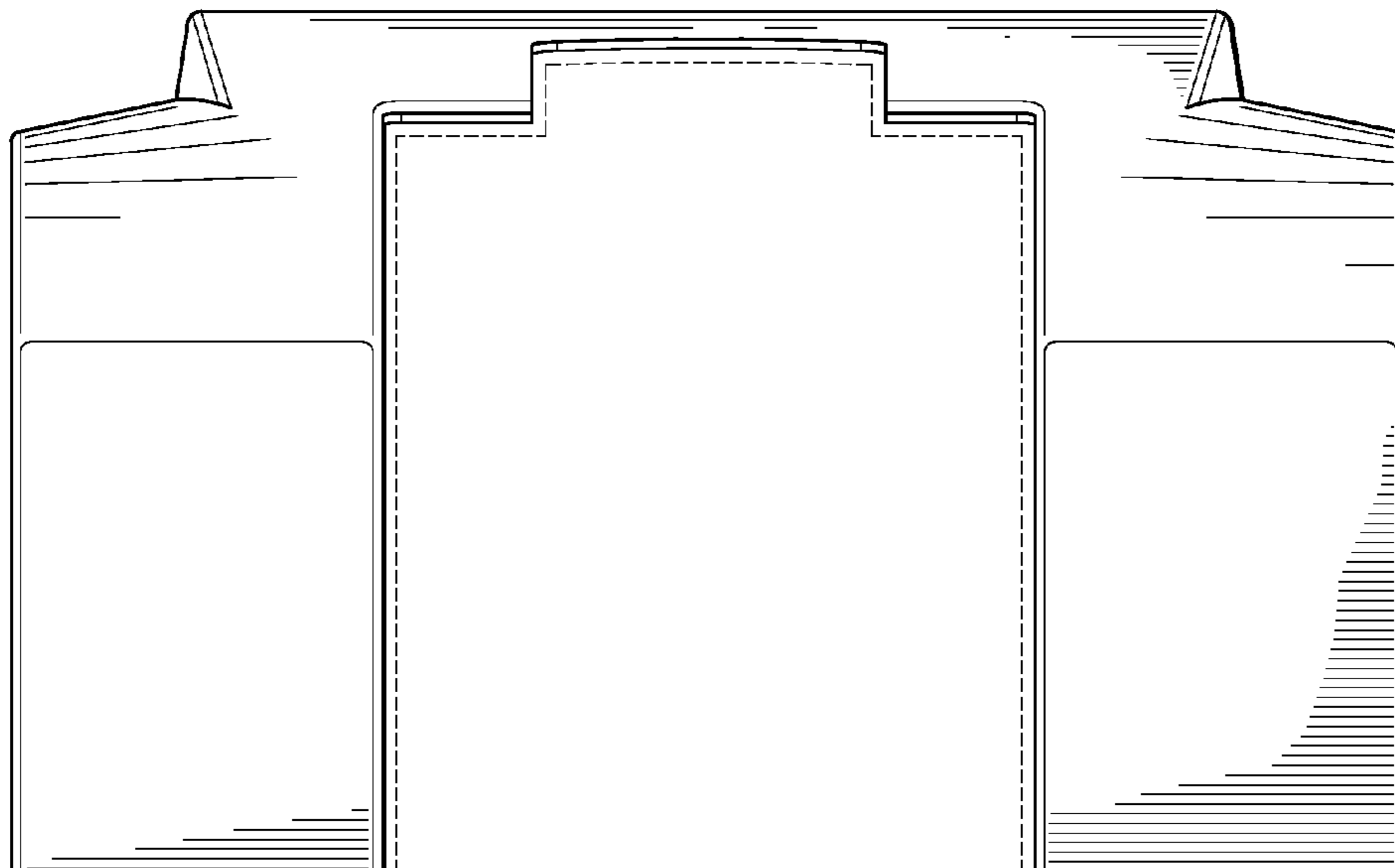
*FIG. 8*



*FIG. 9*

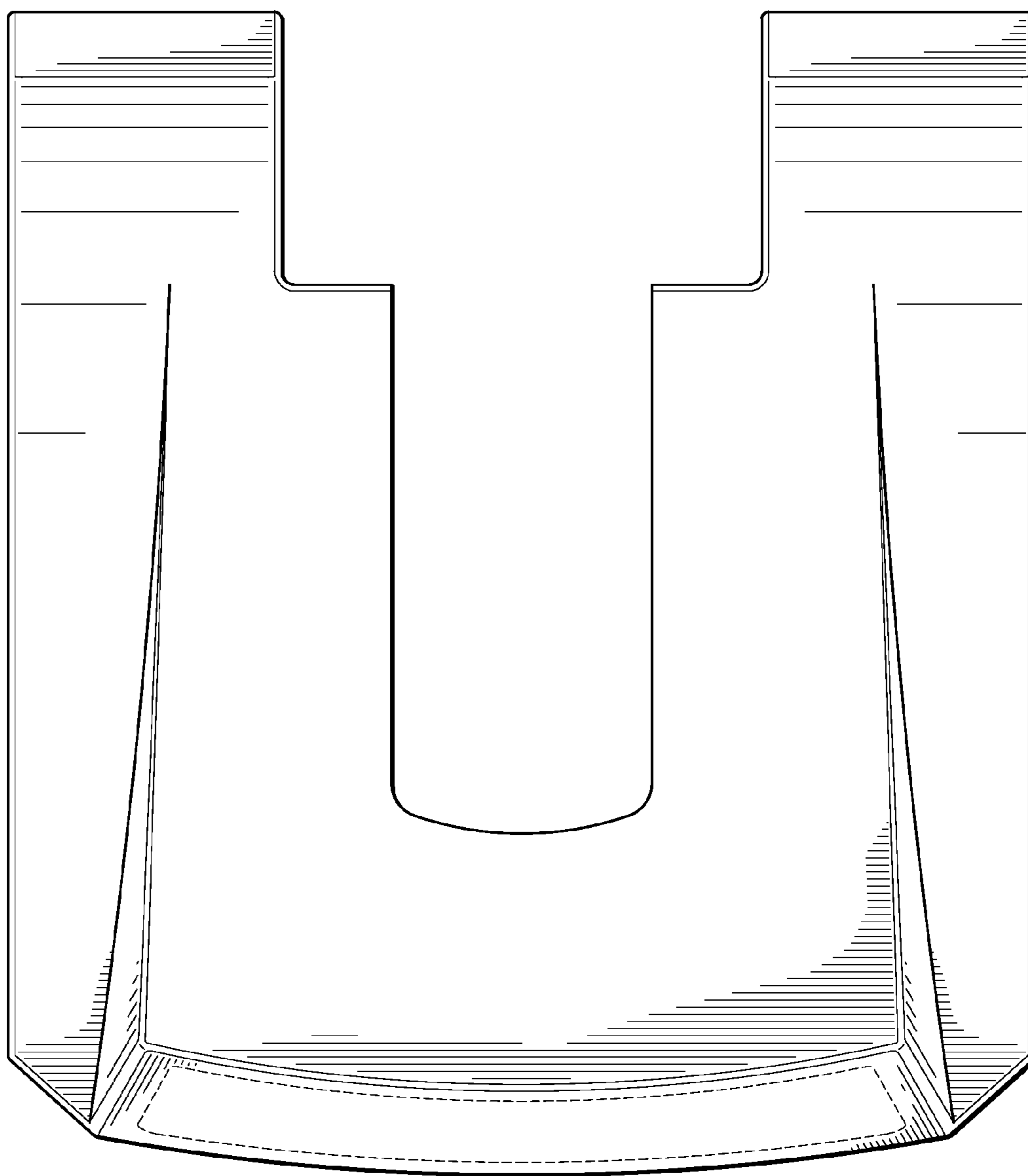


*FIG. 10*



*FIG. 11*





*FIG. 12*