

US00D596964S

(12) **United States Design Patent**
Wang et al.

(10) **Patent No.:** **US D596,964 S**
(45) **Date of Patent:** **** Jul. 28, 2009**

(54) **THERMOSTAT HOUSING**

(75) Inventors: **Steven Wang**, Tianjin (CN); **Paul Liu**,
Tianjin (CN); **Gary Yang**, Tianjin (CN);
Levi Geadelmann, Edina, MN (US);
Daniel Sullivan, St. Anthony Village,
MN (US)

(73) Assignee: **Honeywell International Inc.**,
Morristown, NJ (US)

(**) Term: **14 Years**

(21) Appl. No.: **29/324,116**

(22) Filed: **Sep. 5, 2008**

(51) **LOC (9) Cl.** **10-04**

(52) **U.S. Cl.** **D10/50**

(58) **Field of Classification Search** D10/49-50;
236/5, 46 R-46 F, 47, 49.3, 51, 84, 94; 340/7.21-7.24,
340/7.32, 825.6, 825.72, 539.1, 539.14, 539.21,
340/539.26, 426.21, 584.589, 870.17; 374/167;
400/485; 455/420, 226.1

See application file for complete search history.

(56) **References Cited**

U.S. PATENT DOCUMENTS

- 4,079,366 A 3/1978 Wong
- 4,174,807 A 11/1979 Smith et al.
- 4,206,872 A 6/1980 Levine
- 4,224,615 A 9/1980 Penz
- 4,264,034 A 4/1981 Hyltin et al.
- 4,296,334 A 10/1981 Wong et al.
- 4,298,946 A 11/1981 Hartsell et al.
- 4,308,991 A 1/1982 Peinetti et al.
- 4,332,352 A 6/1982 Jaeger
- 4,337,822 A 7/1982 Hyltin et al.
- 4,337,893 A 7/1982 Flanders et al.
- 4,373,664 A 2/1983 Barker et al.
- 4,379,483 A 4/1983 Farley
- 4,382,544 A 5/1983 Stewart
- 4,386,649 A 6/1983 Hines et al.
- 4,388,692 A 6/1983 Jones et al.
- 4,431,134 A 2/1984 Hendricks et al.

- 4,442,972 A 4/1984 Sahay et al.
- 4,446,913 A 5/1984 Krockner
- 4,479,604 A 10/1984 Didner
- 4,503,471 A 3/1985 Hanajima et al.
- 4,506,827 A 3/1985 Jamieson et al.
- 4,556,169 A 12/1985 Zervos
- 4,606,401 A 8/1986 Levine et al.
- 4,621,336 A 11/1986 Brown
- 4,622,544 A 11/1986 Bially et al.
- 4,628,201 A 12/1986 Schmitt
- 4,646,964 A 3/1987 Parker et al.
- 4,717,333 A 1/1988 Carignan
- 4,725,001 A 2/1988 Carney et al.
- 4,837,731 A 6/1989 Levine et al.

(Continued)

FOREIGN PATENT DOCUMENTS

DE 3334117 4/1985

(Continued)

OTHER PUBLICATIONS

“CorAccess Systems/In Home,” <http://web.archive.org/web/20011212084427/www.coraccess.com/home.html>, 1 page,
copyright 2001, printed Aug. 19, 2004.

(Continued)

Primary Examiner—Antoine D Davis

(57) **CLAIM**

The ornamental design for a thermostat housing, as shown
and described.

DESCRIPTION

FIG. 1 is a perspective view of the thermostat housing;
FIG. 2 is a front elevation view of the thermostat housing of
FIG. 1; and,
FIGS. 3-6 are left, right, top and bottom views, respectively,
of the thermostat housing of FIG. 1.
The portions illustrated in broken lines on the figures are for
illustrative purposes only and form no part of the claimed
design.

1 Claim, 6 Drawing Sheets

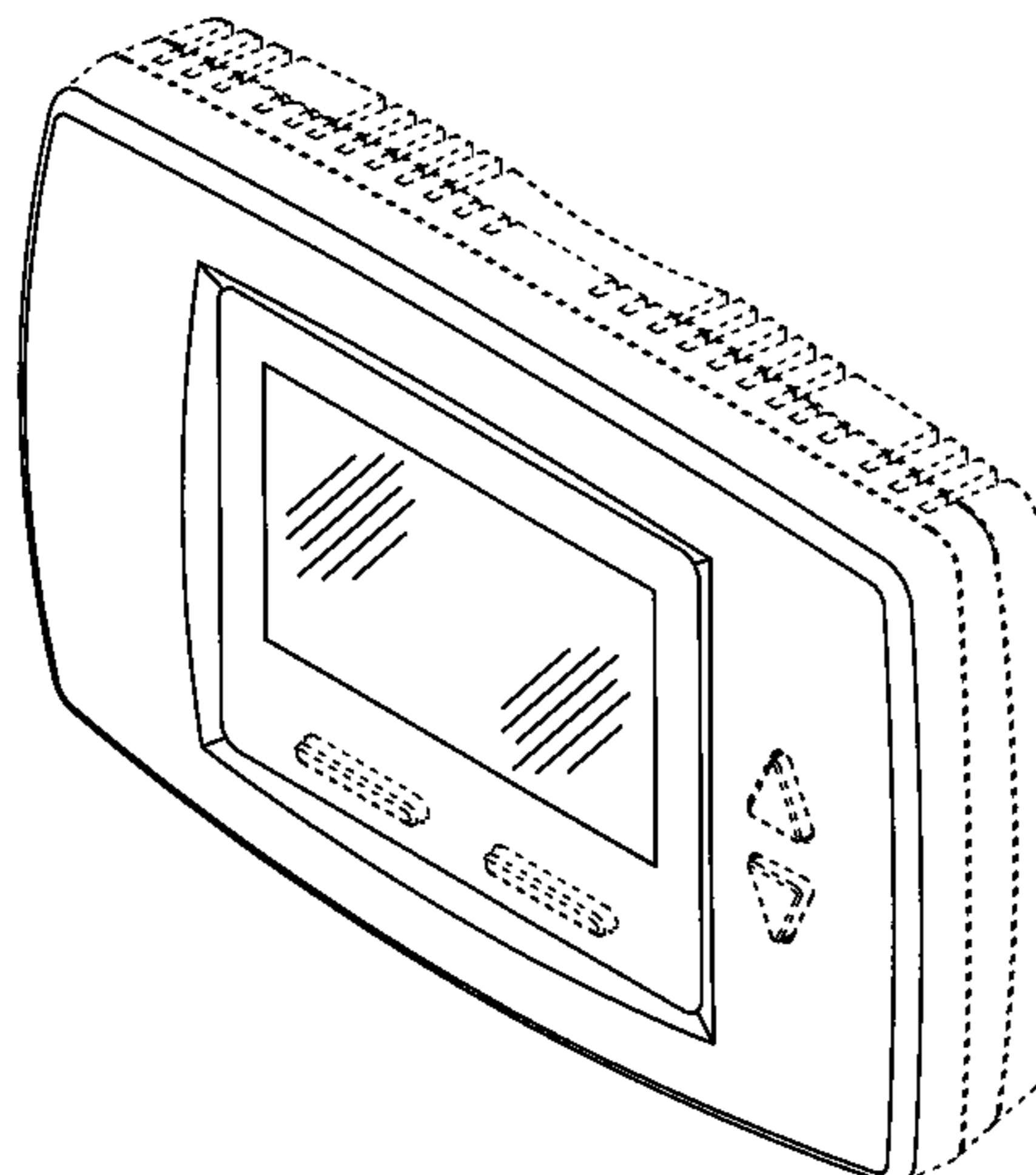

US D596,964 S

Page 2

U.S. PATENT DOCUMENTS							
4,881,686	A	11/1989	Mehta	6,398,118	B1	6/2002	Rosen et al.
4,918,439	A	4/1990	Wozniak et al.	6,453,687	B2	9/2002	Sharood et al.
4,948,040	A	8/1990	Kobayashi et al.	6,466,132	B1	10/2002	Caronna et al.
4,992,779	A	2/1991	Sugino et al.	6,478,233	B1	11/2002	Shah
4,997,029	A	3/1991	Otsuka et al.	6,502,758	B2	1/2003	Cottrell
5,005,365	A	4/1991	Lynch	6,518,953	B1	2/2003	Armstrong
5,012,973	A	5/1991	Dick et al.	6,518,957	B1	2/2003	Lehtinen et al.
5,038,851	A	8/1991	Mehta	6,546,419	B1	4/2003	Humpleman et al.
5,053,752	A	10/1991	Epstein et al.	6,556,899	B1	4/2003	Harvey et al.
5,065,813	A	11/1991	Berkeley et al.	6,578,770	B1	6/2003	Rosen
5,086,385	A	2/1992	Launey et al.	6,580,950	B1	6/2003	Johnson et al.
5,088,645	A	2/1992	Bell	6,581,846	B1	6/2003	Rosen
5,140,310	A	8/1992	DeLuca et al.	6,595,430	B1	7/2003	Shah
5,161,606	A	11/1992	Berkeley et al.	6,608,560	B2	8/2003	Abrams
5,170,935	A	12/1992	Federspiel et al.	6,619,555	B2	9/2003	Rosen
5,172,565	A	12/1992	Wruck et al.	6,621,507	B1	9/2003	Shah
5,181,653	A	1/1993	Foster et al.	6,726,112	B1	4/2004	Ho
5,187,797	A	2/1993	Nielsen et al.	6,786,421	B2	9/2004	Rosen
5,230,482	A	7/1993	Ratz et al.	6,789,739	B2	9/2004	Rosen
5,238,184	A	8/1993	Adams	6,868,293	B1	3/2005	Schurr et al.
5,251,813	A	10/1993	Kniepkamp	D506,687	S	6/2005	Takach et al.
5,259,445	A	11/1993	Pratt et al.	D509,151	S *	9/2005	Takach et al. D10/50
5,329,991	A	7/1994	Mehta et al.	D518,744	S	4/2006	Rosen
5,348,078	A	9/1994	Dushane et al.	D520,386	S	5/2006	Takach et al.
5,386,577	A	1/1995	Zenda	D520,885	S	5/2006	Takach et al.
5,404,934	A	4/1995	Carlson et al.	7,050,026	B1	5/2006	Rosen
5,414,618	A	5/1995	Mock et al.	D525,154	S	7/2006	Moore
5,482,209	A	1/1996	Cochran et al.	D525,541	S	7/2006	Barton et al.
5,526,422	A	6/1996	Keen	D527,658	S	9/2006	Moore
5,537,106	A	7/1996	Mitcuhashi	D531,526	S	11/2006	Barton et al.
5,566,879	A	10/1996	Longtin	7,152,806	B1	12/2006	Rosen
5,570,837	A	11/1996	Brown et al.	D535,572	S *	1/2007	Takach et al. D10/50
5,673,850	A	10/1997	Uptegraph	D535,573	S	1/2007	Barton et al.
5,682,206	A	10/1997	Wehmeyer et al.	7,156,318	B1	1/2007	Rosen
5,732,691	A	3/1998	Maiello et al.	D541,184	S	4/2007	Barton et al.
5,782,296	A	7/1998	Mehta	D542,677	S	5/2007	Barton et al.
5,818,428	A	10/1998	Eisenbrandt et al.	D551,577	S	9/2007	Barton et al.
5,873,519	A	2/1999	Beilfuss	D556,061	S *	11/2007	Rosen D10/50
5,886,697	A	3/1999	Naughton et al.	D556,608	S	12/2007	Rhodes
5,902,183	A	5/1999	D'Souza	D558,073	S	12/2007	Simon et al.
5,915,473	A	6/1999	Ganesh et al.	RE40,190	E *	4/2008	Takach et al. D10/50
5,937,942	A	8/1999	Bias et al.	D566,597	S	4/2008	Schneor
5,947,372	A	9/1999	Tiernan	D579,798	S *	11/2008	Kachlick et al. D10/50
5,950,709	A	9/1999	Krueger et al.	2001/0029585	A1	10/2001	Simon et al.
6,009,355	A	12/1999	Obradovich et al.	2001/0042684	A1	11/2001	Essalik et al.
D418,762	S	1/2000	Dushane et al.	2001/0052459	A1	12/2001	Essalik et al.
6,020,881	A	2/2000	Naughton et al.	2002/0005435	A1	1/2002	Cottrell
6,032,867	A	3/2000	Dushane et al.	2002/0011923	A1	1/2002	Cunningham et al.
6,059,195	A	5/2000	Adams et al.	2002/0022991	A1	2/2002	Sharood et al.
6,081,197	A	6/2000	Garrick et al.	2002/0060701	A1	5/2002	Naughton et al.
6,101,824	A	8/2000	Meyer et al.	2002/0092779	A1	7/2002	Essalik et al.
6,104,963	A	8/2000	Cebasek et al.	2002/0096572	A1	7/2002	Chene et al.
6,119,125	A	9/2000	Gloudeman et al.	2002/0138184	A1	9/2002	Kipersztok et al.
6,121,875	A	9/2000	Hamm et al.	2002/0173929	A1	11/2002	Seigel
6,140,987	A	10/2000	Stein et al.	2003/0000692	A1	1/2003	Takaski et al.
6,141,595	A	10/2000	Gloudeman et al.	2003/0014179	A1	1/2003	Szukala et al.
6,149,065	A	11/2000	White et al.	2003/0033156	A1	2/2003	McCall
6,154,681	A	11/2000	Drees et al.	2003/0033230	A1	2/2003	McCall
6,167,316	A	12/2000	Gloudeman et al.	2003/0034897	A1	2/2003	Shamoon et al.
6,192,282	B1	2/2001	Smith et al.	2003/0034898	A1	2/2003	Shamoon et al.
6,196,467	B1	3/2001	Dushane et al.	2003/0074489	A1	4/2003	Steger et al.
6,208,331	B1	3/2001	Singh et al.	2003/0121652	A1	7/2003	Carey et al.
6,216,956	B1	4/2001	Ehlers et al.	2003/0123224	A1	7/2003	LaCroix et al.
6,236,326	B1	5/2001	Murphy	2003/0136135	A1	7/2003	Kim et al.
6,285,912	B1	9/2001	Ellison et al.	2003/0142121	A1	7/2003	Rosen
6,290,140	B1	9/2001	Pesko et al.	2003/0150926	A1	8/2003	Rosen
6,315,211	B1	11/2001	Sartain et al.	2003/0150927	A1	8/2003	Rosen
6,318,639	B1	11/2001	Toth	2003/0177012	A1	9/2003	Drennan
6,330,806	B1	12/2001	Beaverson et al.	2004/0074978	A1	4/2004	Rosen
6,344,861	B1	2/2002	Naughton et al.	2004/0193324	A1	9/2004	Hoog et al.
6,351,693	B1	2/2002	Monie et al.	2004/0245352	A1	12/2004	Smith

2004/0262410 A1* 12/2004 Hull 236/91 R
 2006/0102732 A1* 5/2006 Garrett et al. 236/94

FOREIGN PATENT DOCUMENTS

EP	0070414	1/1983
EP	0678204	3/2000
EP	0985994	3/2000
EP	1033641	9/2000
EP	1074009	7/2001
FR	2711230	4/1995
WO	WO 97/11448	3/1997
WO	WO 97/39392	10/1997
WO	WO 00/43870	7/2000
WO	WO 01/52515	7/2001
WO	WO 01/79952	10/2001

OTHER PUBLICATIONS

“Hai Company Background,” http://www.homeauto.com/AboutHAI/abouthai_main.htm, 2 pages, printed Aug. 19, 2004.
 “High-tech options take hold in new homes—200-08-28—Dallas Business Journal,” <http://bizjournals.com/dallas/stories/2000/08/28/focus4>, 3 pages, dated Aug. 28, 2000, printed Aug. 19, 2004.
 “Home Toys Review—TouchLinc”, <http://www.hometoys.com/htinews/aug99/reviews/touchlinc/touchlinc.htm>, 3 pages, dated Aug. 1999, printed Aug. 20, 2004.
 “HTI New Release,” <http://www.hometoys.com/htinews/apr99/releases/ha101.htm>, 3 pages, Apr. 1999.
 “Mark of Excellence Award Finalist Announced,” <http://64.233.167.104/search?Q=cache:ciOA2YtYaBIJ:www.hometoys.com/releases/mar...>, 6 pages, Leopard Touchscreen on p. 2, dated prior to Mar. 4, 2000, printed Aug. 20, 2004.
 “Product Review—Philips Pronto Remote Control,” http://hometheaterhifi.com/volume_6_2/philipsprontoremotecontrol.html, 5 pages, dated May 1999, printed Aug. 20, 2004.
 “RC X10 Automation Forum: Control your Heating and Cooling System with Pronto(1/1),” <http://www.remotecentral.com/cgi-bin/mboard/rc-x10/thread.cgi?12>, 2 pages, dated Apr. 23, 1999, printed Aug. 20, 2004.
 “Spotlight on integrated systems,” Custom Builder, V8, N2, p. 66(6), Mar.-Apr. 1993.
 “Vantage Expands Controls For Audio/Video, HVAC and Security,” <http://www.hometoys.com/htinews/aug99/releases/vantage03.htm>, 2 pages, dated Aug. 3, 1999, printed Aug. 20, 2004.
 ADI, “Leopard User Manual,” 93 pages, 2001.
 Adicon 2500, “The Automator,” 4 pages, Oct.-Dec. 2000.
 ADT Security Services, “iCenter Advanced User Interface 8142ADT,” Installation and Setup Guide, 5 pages, May 2001; First Sale Feb. 2001.
 Aprilaire Electronic Thermostats Models 8344, 8346, 8348, 8363, 8365, 8366 Operating Instructions, 8 pages, 2003.
 Aube Technologies, Electronic Thermostat for Heating System Model TH135-01, 5 pages, Aug. 14, 2001.
 Aube Technologies, TH140-28 Electronic Programmable Thermostat, Installation Instructions and User Guide, pp. 1-4, Jan. 22, 2004.
 AutomatedBuildings.com Article—“Thin Client” Solutions, “Pressure, Air Flow, Temperature, Humidity & Valves,” Dwyer Instruments, Inc., 5 pages, printed Sep. 20, 2004.
 Blake et al., “Seng 310 Final Project Demo Program” Illustration, 3 pages, Apr. 6, 2001.
 Blake et al., “Seng 310 Final Project” Report, dated Apr. 6, 2001.
 Blister Pack Insert from a Ritetemp 8082 Touch Screen Thermostat Product, 2 pages, 2002.
 Braeburn Model 3000 Owner’s Manual, pp. 1-13, 2001.
 Braeburn Model 5000 Owner’s Manual, pp. 1-17, 2001.
 BRK Electronics Maximum Protection Plus Ultimate Convenience Smoke Alarm, 24 pages, Sep. 2000.
 BRK First Alert, User’s Manual, Smoke and Fire Alarms, pp. 1-7, Nov. 2002.
 Business Wire, “MicroTouch Specialty Products Group to Capitalize on Growing Market for Low-Cost Digital Matrix Touchscreens,” p. 1174 (2 pages), Jan. 6, 1999.

Cardio Manual, available at <http://www.secant.ca/En/Documentation/Cardio2é-Manual.pdf>, Cardio Home Automation Inc., 55 pages, printed Sep. 28, 2004.
 Cardio, by Secant; <http://www.hometoys.com/htinews/apr98/reviews/cardio.htm>, “HTINews Review,” Feb. 1998, 5 pages, printed Sep. 14, 2004.
 Carrier Microelectronic Programmable Thermostat Owner’s Manual, pp. 1-24, May 1994.
 Carrier TSTATCCRF01 Programmable Digital Thermostat, pp. 1-21, prior to Apr. 21, 2005.
 Carrier, “Programmable Dual Fuel Thermostat,” Installation, Start-Up & Operating Instructions, pp. 1-12, Oct. 1998.
 Carrier, “Programmable Thermostats,” Installation, Start-Up & Operating Instructions, pp. 1-16, Sep. 1998.
 Carrier, “Standard Programmable Thermostat,” Homeowner’s Manual, pp. 1-8 pages, 1998.
 Carrier, “Thermidistat Control,” Installation, Start-Up, and Operating Instructions, pp. 1-12, Aug. 1999.
 Climatouch, User Manual, Climatouch CT03TSB Thermostat, Climatouch CT03TSHB Thermostat with Humidity Control, Outdoor UHF Temperature Transmitter 217S31, 19 pages, Printed Sep. 15, 2004.
 CorAccess, “Companion 6,” User Guide, pp. 1-20, Jun. 17, 2002.
 Danfoss RT51/51RF & RT52/52RF User Instructions, 2 pages, Jun. 2004.
 DeKoven et al., “Designing Collaboration in Consumer Products,” 2 pages, 2001.
 DeKoven et al., “Measuring Task Models in Designing Intelligent Products,” 2 pages, Jan. 13-16, 2002.
 Domotique Secant Home Automation—Web Page, available at <http://www.secant.ca/En/Company/Default.asp>, 1 page, printed Sep. 28, 2004.
 Firex Smoke Alarm, Ionization Models AD, ADC Photoelectric Model Pad, 4 pages, prior to Apr. 21, 2005.
 Freudenthal et al., “Communicating extensive smart home functionality to users of all ages: the design of a mixed-initiative multimodal thermostat-interface,” pp. 34-39, Mar. 12-13, 2001.
 Gentex Corporation, HD135, 135° Fixed Temperature Heat Detector AC Pwered, 120V, 60Hz, With Battery Backup, Installation Instructions—Owner’s Information, pp. 1-5, Jun. 1, 1998.
 Gentex Corporation, 9000 Series, Photoelectric Type Single Station/Multi-Station Smoke Alarms AC Powered With Battery Backup, Installation Instructions—Owner’s Information, pp. 9-1 to 9-6, Jan. 1, 1993.
 Honeywell Brivis Deluxe Programmable Thermostat, pp. 1-20, 2002.
 Honeywell Brivis T8602C Chronotherm IV Deluxe Programmable Thermostat, Installation Instructions, pp. 1-12, 2002.
 Honeywell CT8602C Professional Fuel Saver Thermostat, pp. 1-6, 1995.
 Honeywell Electronic Programmable Thermostat, Owner’s Guide, pp. 1-20, 2003.
 Honeywell Electronic Programmable Thermostats, Installation Instructions, pp. 1-8, 2003.
 Honeywell News Release, “Honeywell’s New Sysnet Facilities Integration System For Boiler Plant and Combustion Safety Processes,” 4 pages, Dec. 15, 1995.
 Honeywell T8002 Programmable Thermostat, Installation Instructions, pp. 1-8, 2002.
 Honeywell T8602A,B,C,D and TS8602A,C Chronotherm III Fuel Saver Thermostats, Installation Instructions, pp. 1-12, 1995.
 Honeywell T8602D Chronotherm IV Deluxe Programmable Thermostats, Installation Instructions, pp. 1-12, 2002.
 Honeywell TH8000 Series Programmable Thermostats, Owner’s Guide, pp. 1-44, 2004.
 Honeywell, “Introduction of the S7350A Honeywell WebPAD Information Appliance,” Home and Building Control Bulletin, 2 pages, Aug. 29, 2000; Picture of WebPad Device with touch screen, 1 Page; and screen shots of WebPad Device, 4 pages.
 Honeywell, “W7006A Home Controller Gateway User Guide,” 31 pages, Jul. 2001.
 Honeywell, MagicStat® CT3200 Programmable Thermostat, Installation and Programming Instructions, pp. 1-24, 2001.

- http://www.cc.gatech.edu/computing/classes/cs6751_94_fall/groupc/climate-2/node1.html, "Contents," 53 pages, printed Sep. 20, 2004.
- http://www.ritetemp.info/rtMenu_13.html, Rite Temp 8082, 8 pages, printed Jun. 20, 2003.
- <http://www.thermostatsales.com>, Robertshaw, "9610 Digital Programmable Thermostat," 3 pages, printed Jun. 17, 2004.
- <http://www.thermostatsales.com>, Robertshaw, "9700 Deluxe Programmable Thermostat," 3 pages, printed Jun. 17, 2004.
- <http://www.thermostatsales.com>, Robertshaw, "9710 Deluxe Programmable Thermostat," 3 pages, printed Jun. 17, 2004.
- <http://www.thermostatsales.com>, Robertshaw, "9720 Deluxe Programmable Thermostat," 3 pages, printed Jun. 17, 2004.
- Hunter, "44200/44250," Owner's Manual, 32 pages, prior to Jul. 7, 2004.
- Hunter, "44300/44350," Owner's Manual, 35 pages, prior to Jul. 7, 2004.
- Hunter, "Auto Saver 550", Owner's Manual Model 44550, 44 pages, prior to Jul. 7, 2004.
- Install Guide for Ritetemp Thermostat 8082, 6 pages, 2002.
- Invensys™, "9700i 9701i 9715i 9720i Deluxe Programmable Thermostats," User's Manual, pp. 1-28, prior to Jul. 7, 2004.
- Lux ELV1 Programmable Line Voltage Thermostat, Installation Instructions, 3 pages, prior to Jul. 7, 2004.
- Lux TX500 Series Smart Temp Electronic Thermostat, 3 pages, prior to Jul. 7, 2004.
- Lux TX9000 Installation, 3 pages, prior to Apr. 21, 2005.
- Lux, "511 Series Smart Temp Electronic Thermostat," Owner's Manual, 3 pages, prior to Jul. 7, 2004.
- Lux, "600 Series Smart Temp Electronic Thermostat," Owner's Manual, 3 pages, prior to Jul. 7, 2004.
- Lux, "602 Series Multi-Stage Programmable Thermostat," Owner's Manual, 2 pages, prior to Jul. 7, 2004.
- Lux, "605/2110 Series Programmable Heat Pump Thermostat," Owner's Manual, 3 pages, prior to Jul. 7, 2004.
- Lux, "700/9000 Series Smart Temp Electronic Thermostat," Owner's Manual, 3 pages, prior to Jul. 7, 2004.
- Lux, "PSPH521 Series Programmable Heat Pump Thermostat," Owner's Manual, 3 pages, prior to Jul. 7, 2004.
- Lux, "TX1500 Series Smart Temp Electronic Thermostat," Owner's Manual, 6 pages, prior to Jul. 7, 2004.
- Metasys, "HVAC PRO for Windows User's Manual," 308 pages, 1998.
- Mounting Template for Ritetemp Thermostat 8082, 1 page, 2002.
- Operation Manual for Ritetemp Touch Screen Thermostat 8082, 8 pages, 2002.
- Proliphix, "Web Enabled IP Thermostats, Intelligent HVAC Control," Proliphix Inc., 2 pages, on or before Aug. 28, 2004.
- Proliphix, "Web Enabled IP Thermostats, Ultimate in Energy Efficiency!," Proliphix Inc., 2 pages, on or before Aug. 28, 2004.
- Proliphix, Inc., "NT10e & NT20e," 54 pages, on or before Aug. 30, 2005.
- Quick Start Guide for Ritetemp Thermostat 8082, 1 page, 2002.
- Remote Control Power Requirement for Ritetemp Thermostat 8082, 1 page, 2002.
- Ritetemp Operation 8029, 3 pages, Jun. 19, 2002.
- Ritetemp Operation 8050, 5 pages, Jun. 26, 2002.
- Ritetemp Operation 8085, pp. 1-6, prior to Apr. 21, 2005.
- Sealed Unit Parts Co., Inc., Supco & CTC Thermostats . . . loaded with features, designed for value!, 6 pages, prior to Apr. 21, 2005.
- Totaline Model P474-1035 Owner's Manual Programmable 5-2 Day Digital Thermostat, pp. 1-21, Apr. 2003.
- Totaline Star CPE230RF, Commercial Programmable Thermostat Wireless Transmitter, Owner's Manual, pp. 1-16, Oct. 1998.
- Totaline Star P/N P474-0130 Non-Programmable Digital Thermostat Owner's Manual, pp. 1-22, prior to Apr. 21, 2005.
- Totaline, "1 For All programmable Digital Thermostat," Owner's Manual P/N P374-1100FM, 23 pages, Nov. 1998.
- Totaline, "1 For All Programmable Digital Thermostat," Owner's Manual P/N P474-1050, 21 pages, Nov. 1998.
- Totaline, "1 For All Programmable Digital Thermostat," Owner's Manual P/N P374-1100, 24 pages, Apr. 2001.
- Totaline, "Intellistat Combination Temperature and Humidity Control," Owner's Manual P/N P374-1600, 25 pages, Jun. 2001.
- Totaline, "1 Programmable Thermostat Configurable for Advanced Heat Pump or Dual Fuel Operation," Owner's Manual P/N P374-1500, 24 pages, Jun. 1999.
- Totaline, "Instructions P/N P474-1010", Manual, 2 pages, Dec. 1998.
- Totaline, "1 Programmable Thermostat," Homeowner's Guide, 27 pages, Dec. 1998.
- Totaline, "Wireless Programmable Digital Thermostat," Owner's Manual 474-1100RF, 21 pages, 2000.
- Trouble Shooting Guide for Ritetemp Thermostat 8082, 1 page, 2002.
- Visor Handheld User Guide, Copyright 1999-2000.
- Warmly Yours, "Model TH111GFCI-P (120 VAC)," Manual, pp. 1-4, prior to Jul. 7, 2004.
- White-Rodgers 1F80-224 Programmable Electronic Digital Thermostat, Installation and Operation Instructions, 8 pages, prior to Apr. 21, 2005.
- White-Rodgers Comfort-Set III Thermostat, pp. 1-44, prior to Jul. 7, 2004.
- White-Rodgers Installation Instructions for Heating & Air Conditioning IF78 Non-Programmable Thermostat, 6 pages, prior to Apr. 21, 2005.
- White-Rodgers Installation Instructions for Heating & Air Conditioning IF78 5/2 Day Programmable Thermostat, 7 pages, prior to Jul. 7, 2004.
- White-Rodgers, "Installation Instructions for Heating & Air Conditioning IF72 5/2 Day Programmable Heat Pump Thermostat," 8 pages, prior to Jul. 7, 2004.
- White-Rodgers, "Comfort-Set 90 Series Thermostat," Manual, pp. 1-24, prior to Jul. 7, 2004.
- White-Rodgers, 1F80-240 "(for Heating Only systems) Programmable Electronic Digital Thermostat," Installation and Operation Instructions, 8 pages, prior to Jul. 7, 2004.
- White-Rodgers, 1F80-241 "Programmable Electronic Digital Thermostat," Installation and Operation Instructions, 6 pages, prior to Jul. 7, 2004.
- White-Rodgers, 1F80-261 "Programmable Electronic Digital Thermostat," Installation and Operation Instructions, 8 pages, prior to Jul. 7, 2004.
- White-Rodgers, 1F81-261 "Programmable Electronic Digital Multi-Stage Thermostat," Installation and Operation Instructions, 8 pages, prior to Jul. 7, 2004.
- White-Rodgers, 1F82-261 "Programmable Electronic Digital Heat Pump Thermostat," Installation and Operation Instructions, 8 pages, prior to Jul. 7, 2004.
- White-Rodgers, Comfort-Set 90 Series Premium, 4 pages, prior to Apr. 21, 2005.
- www.icmcontrols.com, Simplecomfort, SC3000 Single Stage Heat/Single Stage Cool or Single Stage Heat Pump/Manual Changeover, 1 page, prior to Jul. 7, 2004.
- www.icmcontrols.com, Simplecomfort, SC3001 Single Stage Heat/Single Stage Cool or Single Stage Heat Pump/Manual Changeover, 1 page, prior to Jul. 7, 2004.
- www.icmcontrols.com, Simplecomfort, SC3006 Single Stage Heat/Single Stage Cool or Single Stage Heat Pump/Manual Changeover, 1 page, prior to Jul. 7, 2004.
- www.icmcontrols.com, Simplecomfort, SC3201 2 Stage Heat Pump Manual Changeover, 1 page, prior to Jul. 7, 2004.
- www.icmcontrols.com, Simplecomfort, SC3801 2 Stage Heat/2 Stage Cool 2 Stage Heat Pump/Audio Changeover, 1 page, prior to Jul. 7, 2004.

* cited by examiner

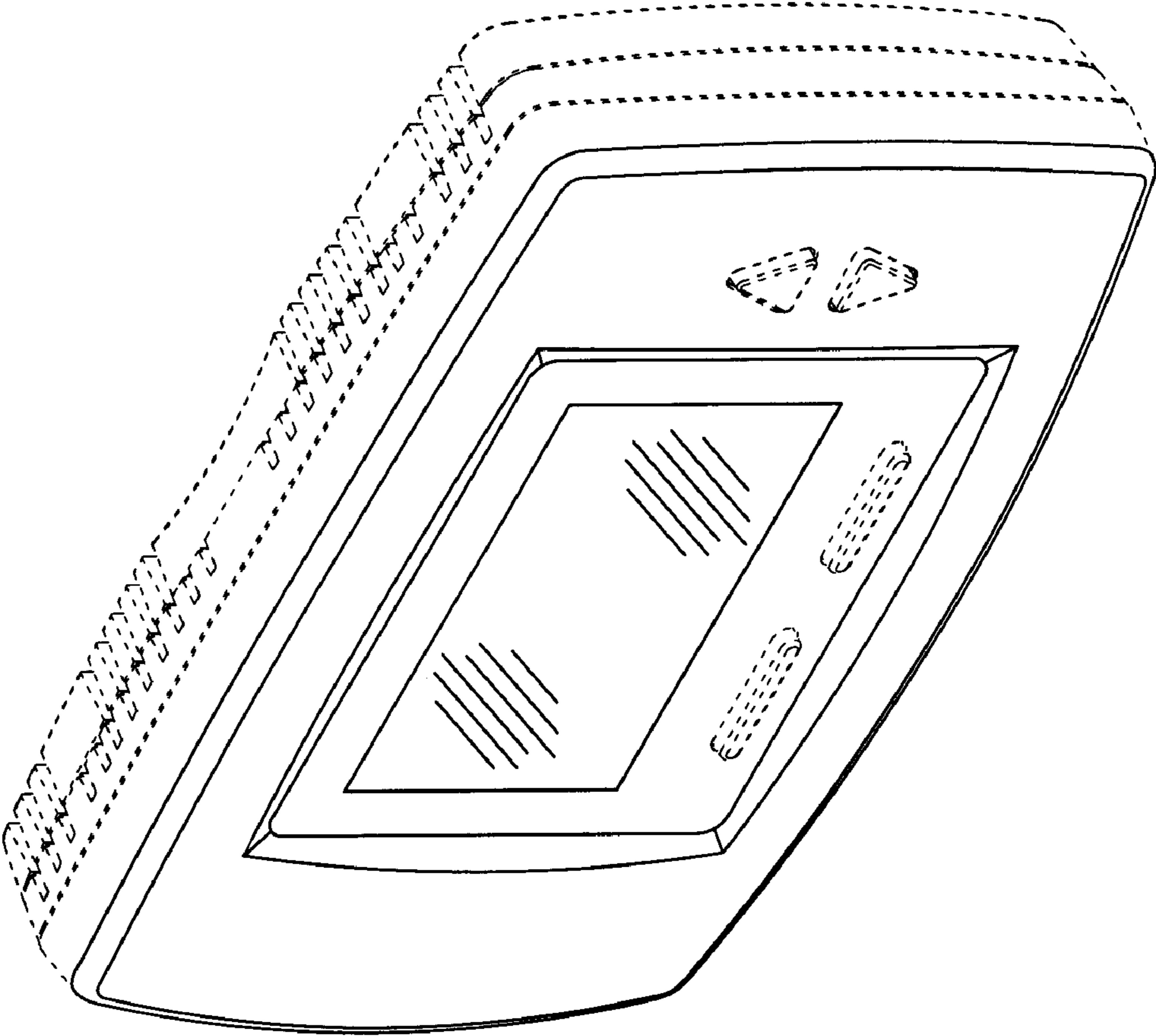

Figure 1

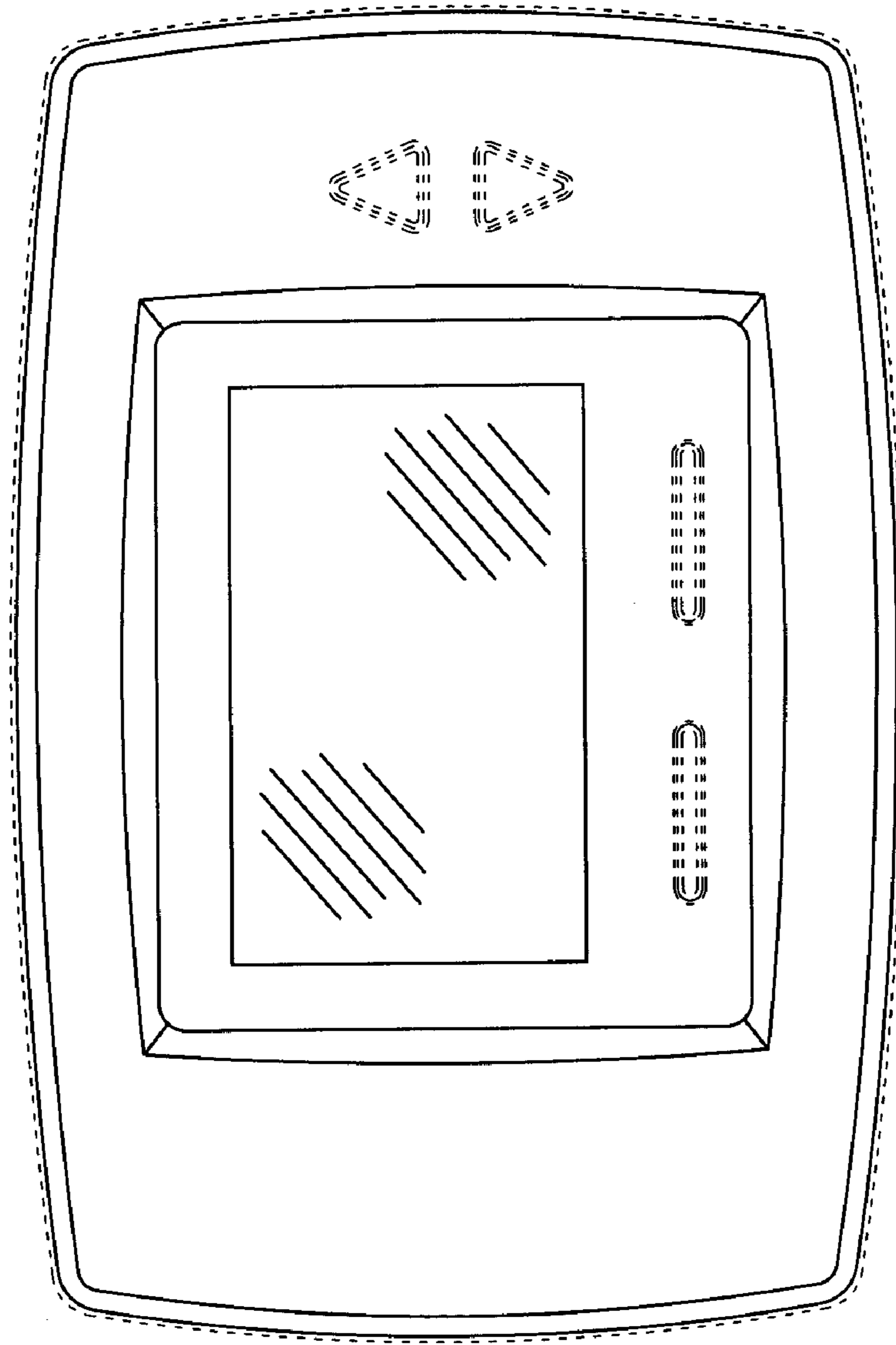

Figure 2

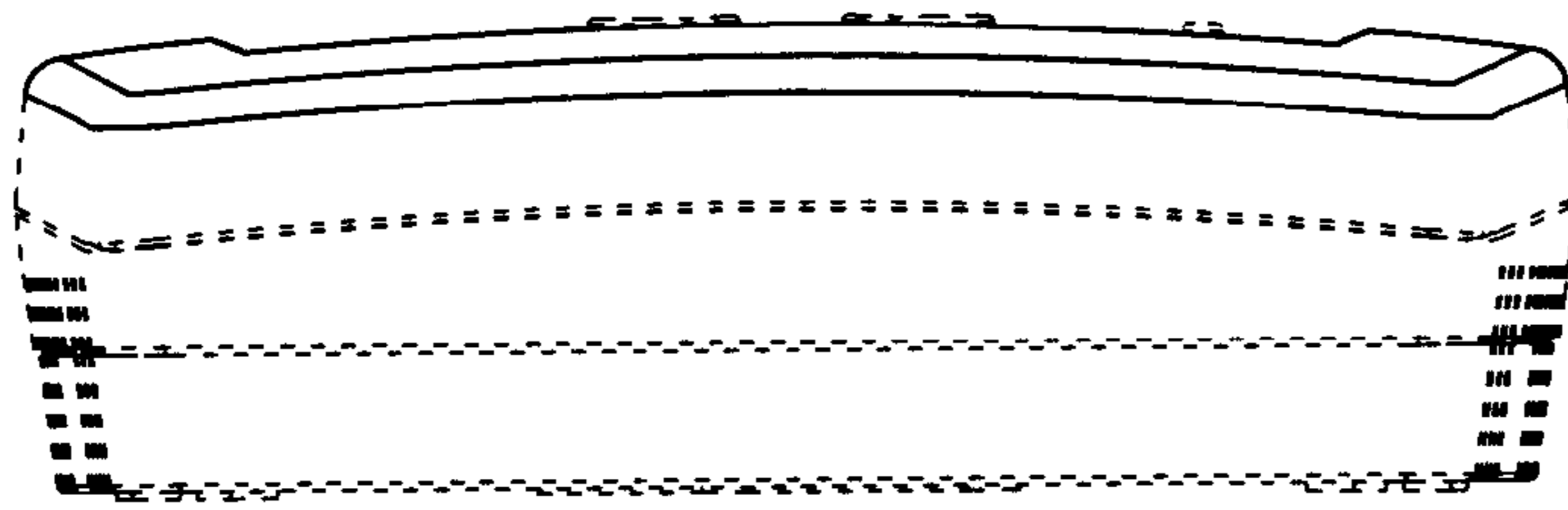

Figure 3

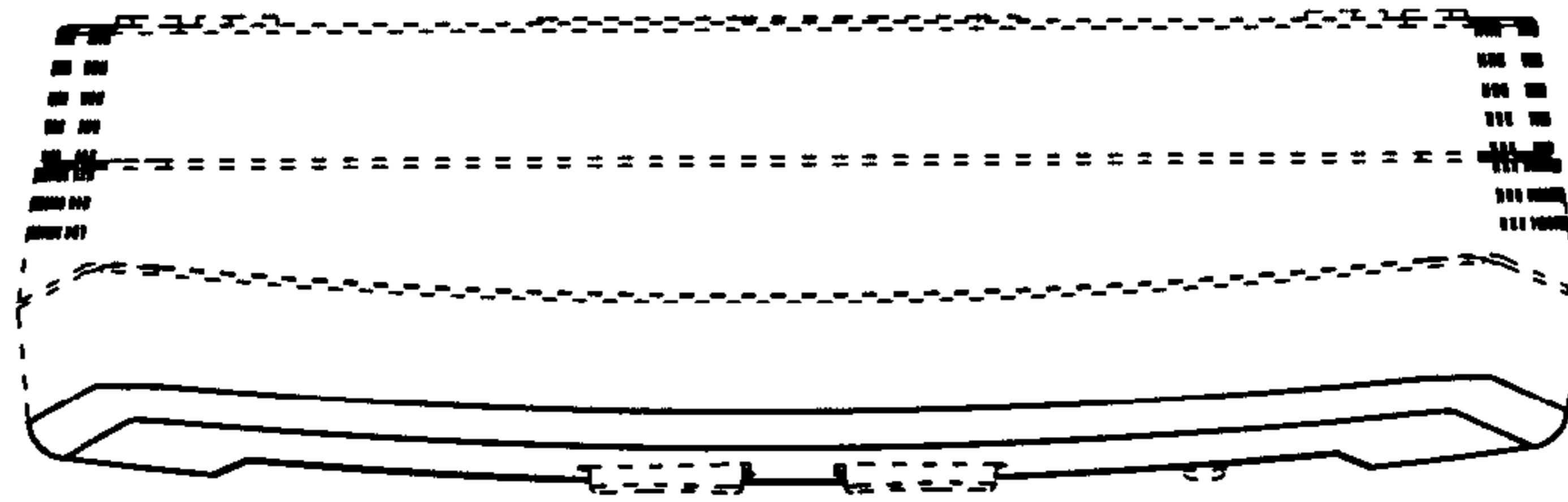

Figure 4

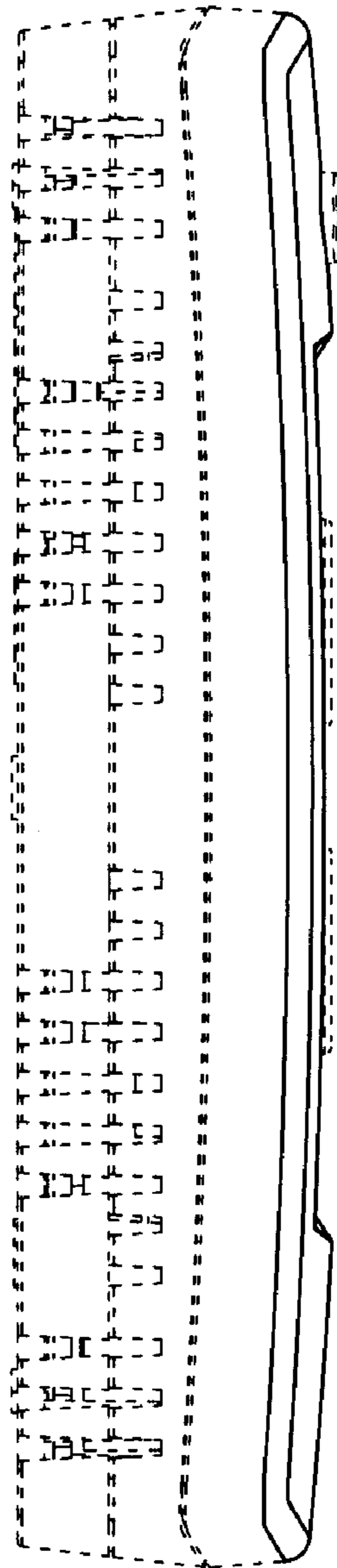

Figure 5

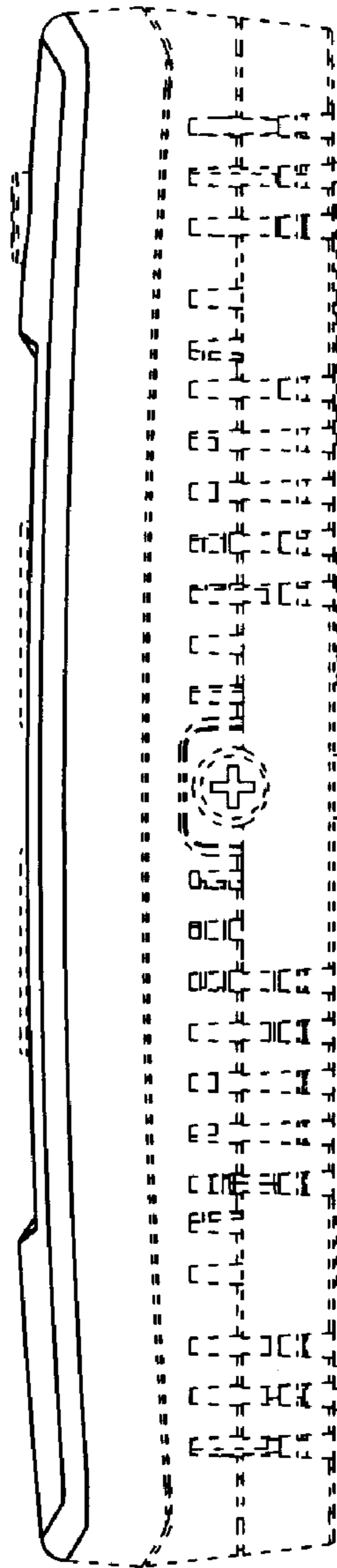

Figure 6