



US00D596953S

(12) **United States Design Patent**
Wonderley et al.

(10) **Patent No.:** **US D596,953 S**
(45) **Date of Patent:** **** Jul. 28, 2009**

(54) **RAZOR TRAY**

JP 2006-232325 9/2006
WO WO 98/36879 8/1998

(75) Inventors: **Jeffrey W. Wonderley**, Fort Defiance, VA (US); **Paradee Bunnag**, Waynesboro, VA (US)

Primary Examiner—Philip S Hyder
Assistant Examiner—Roselyne Cody
(74) *Attorney, Agent, or Firm*—McDermott Will & Emery LLP

(73) Assignee: **American Safety Razor**, Verona, VA (US)

(**) Term: **14 Years**

(57) **CLAIM**

(21) Appl. No.: **29/300,866**

The ornamental design for a razor tray, as shown and described.

(22) Filed: **May 22, 2008**

DESCRIPTION

(51) **LOC (9) Cl.** **09-03**
(52) **U.S. Cl.** **D9/749; D3/205; D3/295**
(58) **Field of Classification Search** D3/201, D3/203.1, 203.3, 203.6, 203.8, 205–206, D3/273, 294, 295; D9/735, 748, 749; D28/73; 206/216, 228, 351, 356, 570, 581, 823; 30/541
See application file for complete search history.

FIG. 1 is a perspective view of the razor tray with its lid open, showing the new design;
FIG. 2 is a front view of the razor tray with its lid open;
FIG. 3 is a rear view of the razor tray with its lid open;
FIG. 4 is a side view of the razor tray with its lid open;
FIG. 5 is another side view of the razor tray with its lid open;
FIG. 6 is a top view of the razor tray with its lid open;
FIG. 7 is a bottom view of the razor tray with its lid open;
FIG. 8 is a top perspective view of the razor tray with its lid closed;
FIG. 9 is a bottom perspective view of the razor tray with its lid closed;
FIG. 10 is a front view of the razor tray with its lid closed;
FIG. 11 is a rear view of the razor tray with its lid closed;
FIG. 12 is a side view of the razor tray with its lid closed;
FIG. 13 is another side view of the razor tray with its lid closed;
FIG. 14 is a top view of the razor tray with its lid closed; and,
FIG. 15 is a bottom view of the razor tray with its lid closed.

(56) **References Cited**

U.S. PATENT DOCUMENTS

2,070,430 A * 2/1937 Wallenthin 206/228

(Continued)

FOREIGN PATENT DOCUMENTS

EP	1 577 228 A1	2/1998
GB	2 245 859 A	1/1992
GB	2 437358 A	10/2007
JP	64-22204	1/1989
JP	64-83206	3/1989
JP	7-222619	8/1995
JP	7-227487	8/1995
JP	2001-2132	1/2001
JP	2001-310088	11/2001
JP	2003-24121	1/2003
JP	2006-75188	3/2006

1 Claim, 11 Drawing Sheets

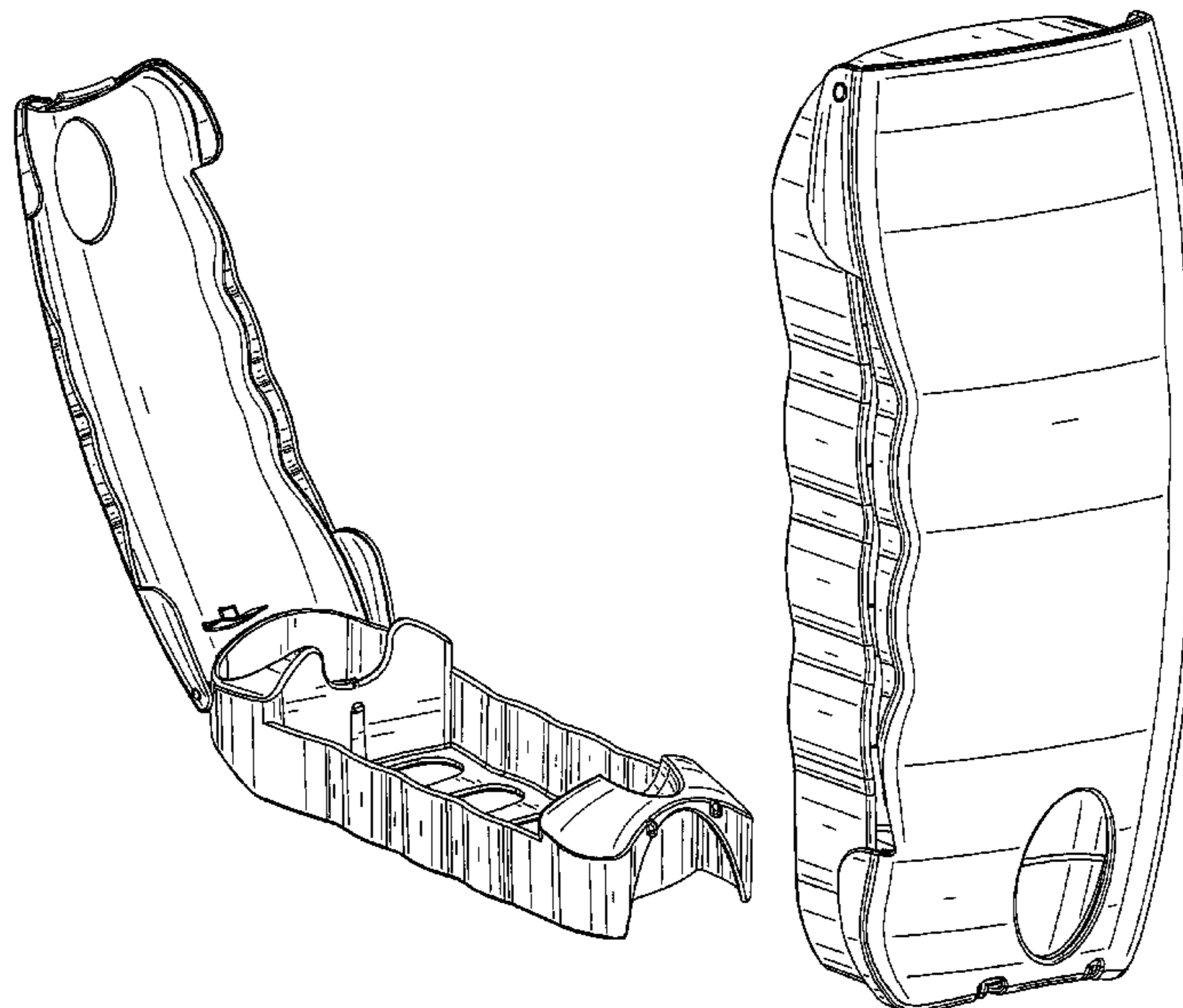

US D596,953 S

Page 2

U.S. PATENT DOCUMENTS

D172,912 S *	8/1954	Wark et al.	D9/748	6,415,517 B1	7/2002	Worrick, III	
2,822,916 A *	2/1958	Wark et al.	206/228	D466,283 S *	12/2002	Kim	D3/205
D198,410 S *	6/1964	Tyte	D9/748	D466,806 S *	12/2002	Chan	D9/424
D216,001 S *	11/1969	Grange	D9/748	6,499,595 B1	12/2002	Petricca	
D216,635 S *	2/1970	Grange	D9/748	D470,306 S *	2/2003	Halpern et al.	D3/205
D259,596 S *	6/1981	Gray	D3/205	D501,955 S *	2/2005	Long et al.	D28/73
D313,175 S	12/1990	Motta et al.		6,886,690 B2	5/2005	Petricca	
5,429,241 A	7/1995	Althaus		7,040,024 B2	5/2006	Lukan et al.	
D366,611 S	1/1996	Poisson		D529,711 S *	10/2006	Shamoon	D3/206
5,518,114 A	5/1996	Kohring et al.		D529,959 S *	10/2006	Oas	D19/36
D397,290 S	8/1998	Petricca et al.		D531,518 S	11/2006	Ramm et al.	
D401,060 S *	11/1998	Delle Donne et al.	D3/264	D534,815 S *	1/2007	White	D9/749
5,867,907 A	2/1999	Terry et al.		7,159,324 B2	1/2007	Worrick, III	
5,946,805 A	9/1999	Oldroyd		D542,675 S *	5/2007	Luxton et al.	D9/749
6,041,926 A	3/2000	Petricca et al.		D551,440 S *	9/2007	Stewart et al.	D3/203.3
6,052,903 A	4/2000	Metcalf et al.		2002/0184770 A1	12/2002	Peysen	
D425,296 S *	5/2000	Shurtleff	D3/205	2005/0198825 A1	9/2005	Apprille, Jr.	
6,192,586 B1	2/2001	Metcalf et al.		2007/0007155 A1	1/2007	Foster	
D449,442 S *	10/2001	Snider	D3/294				

* cited by examiner

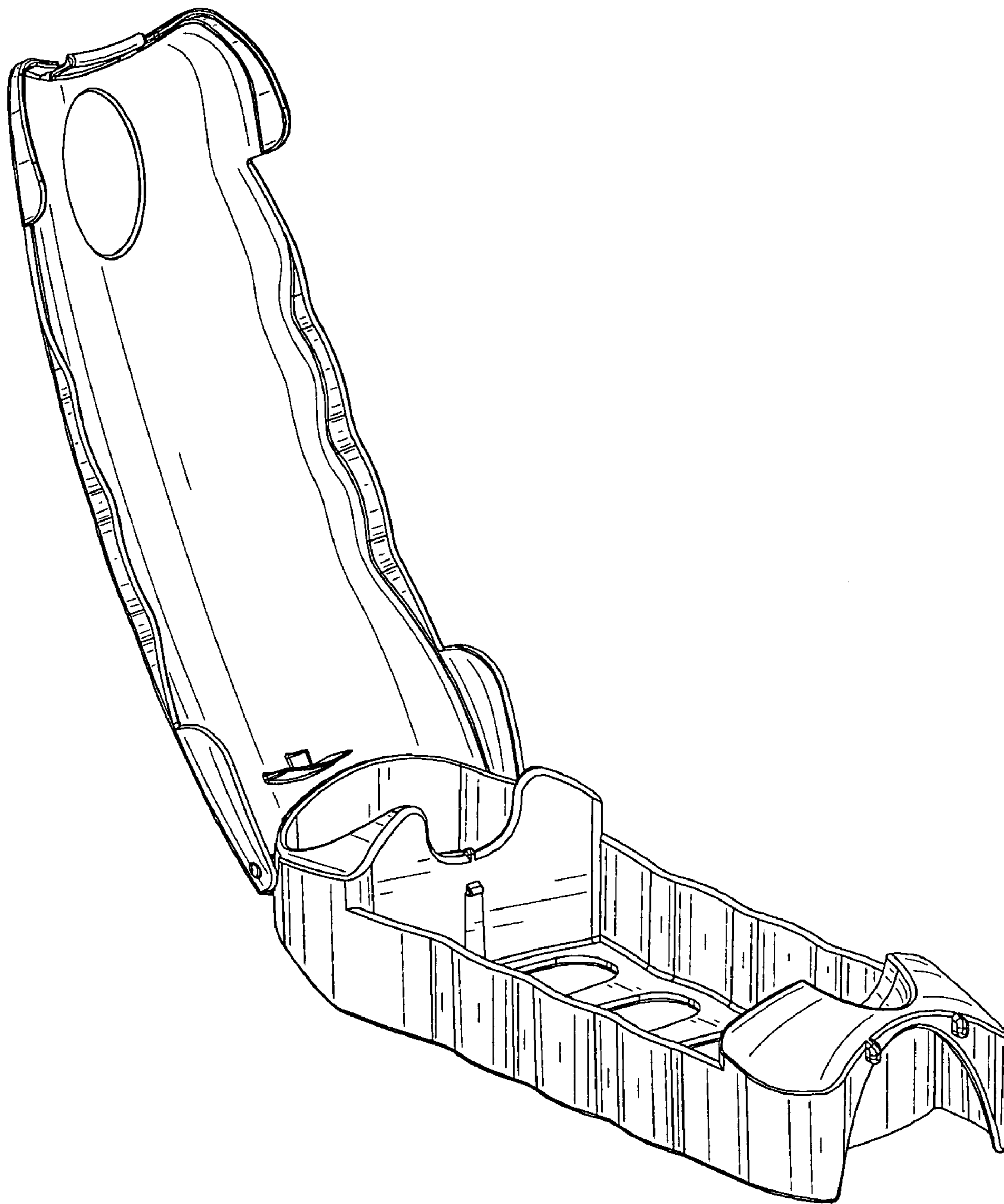

FIG. 1

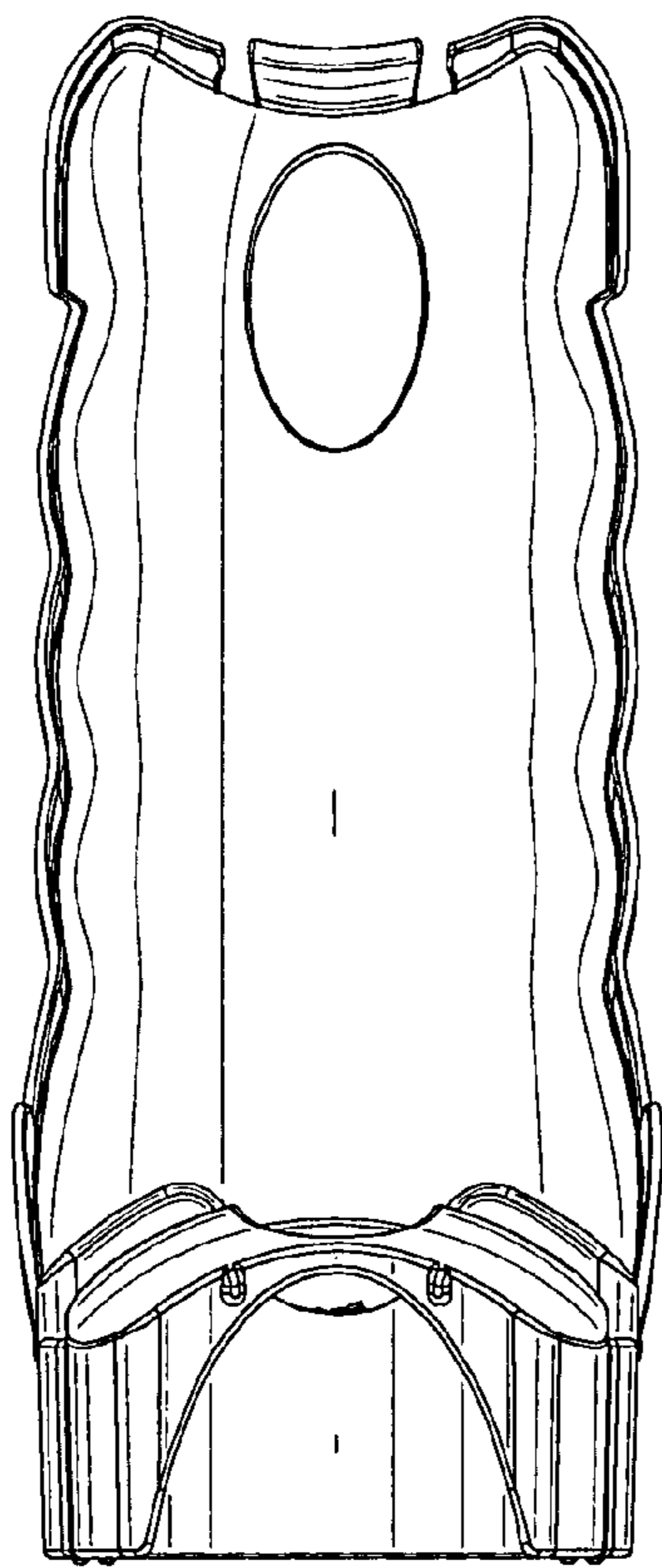

FIG. 2

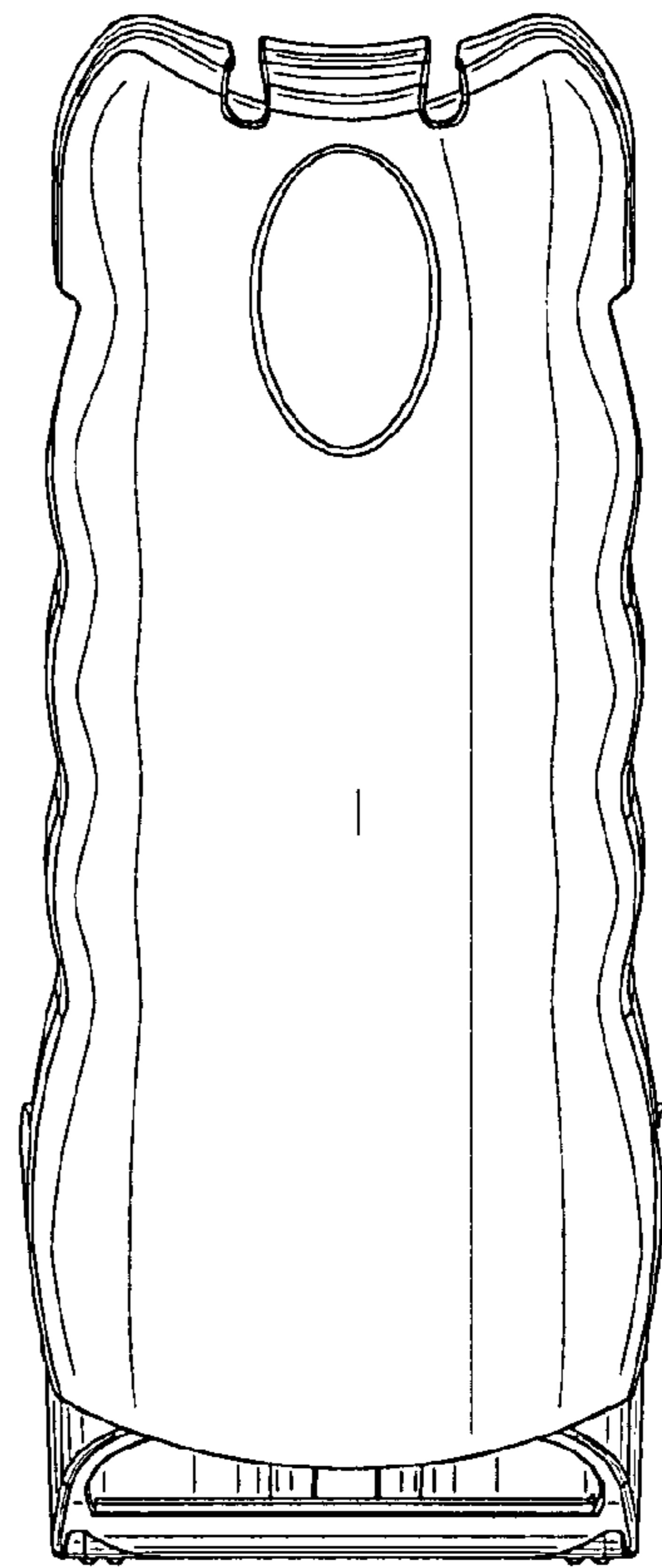

FIG. 3

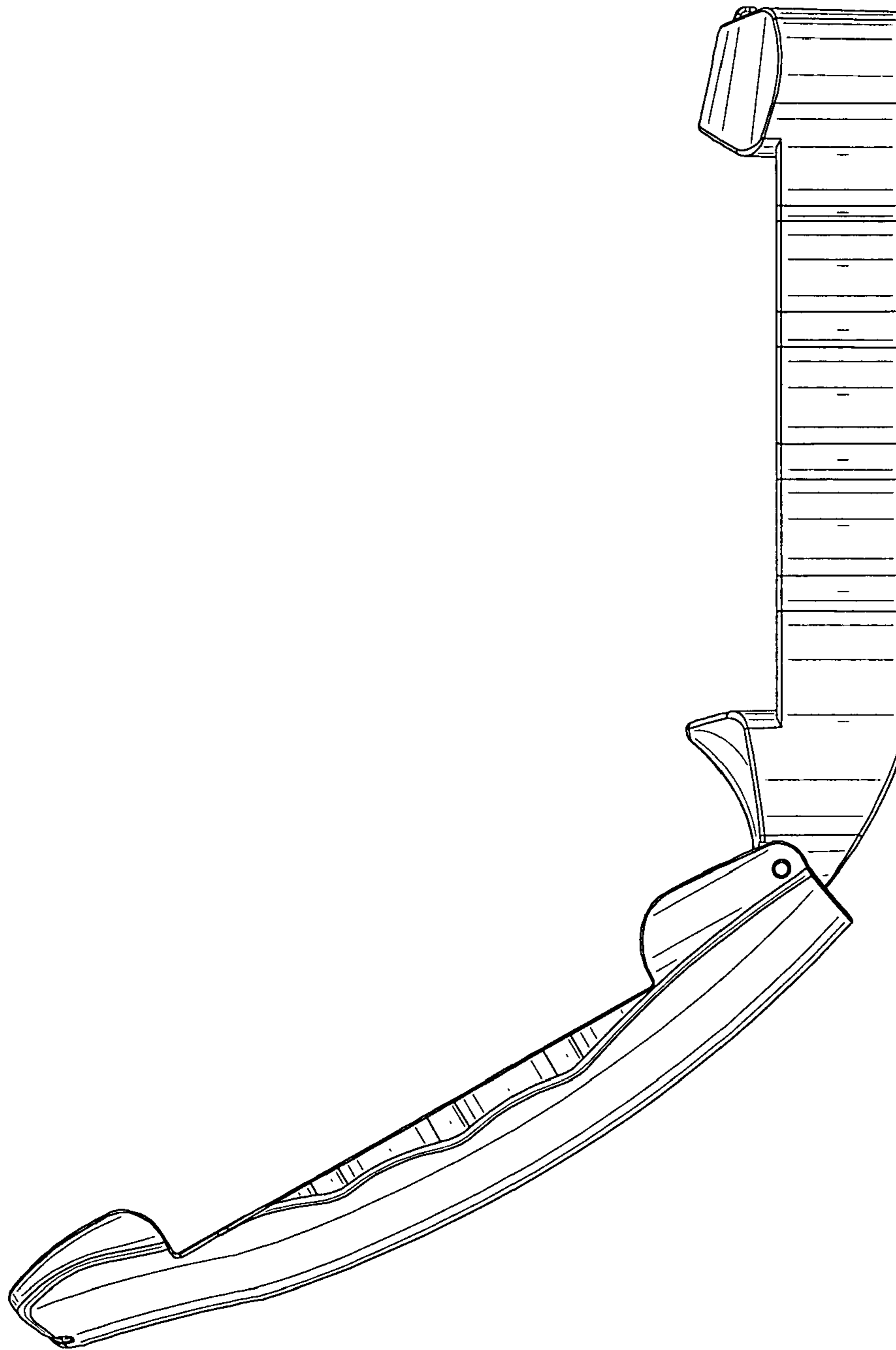

FIG. 4

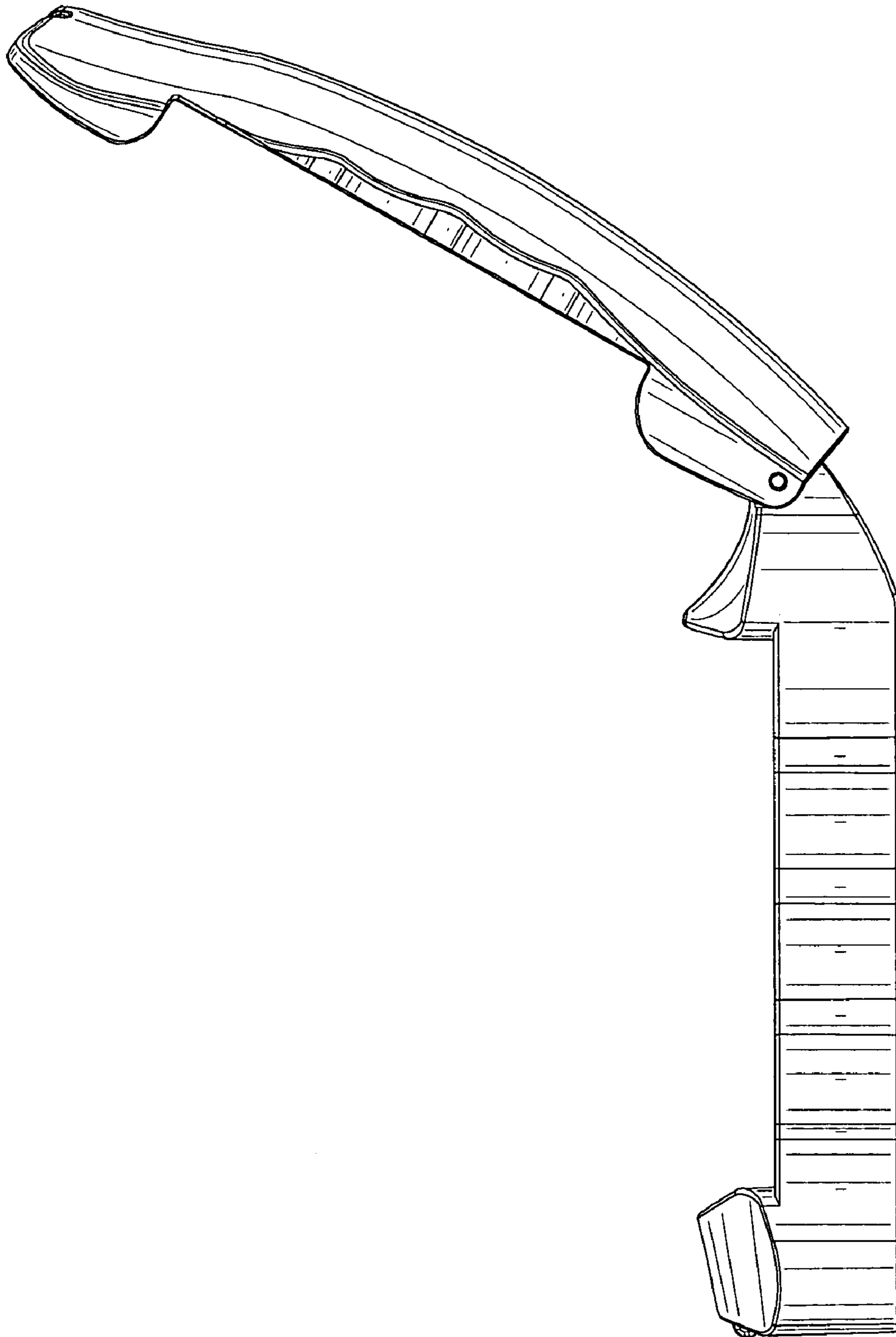

FIG. 5

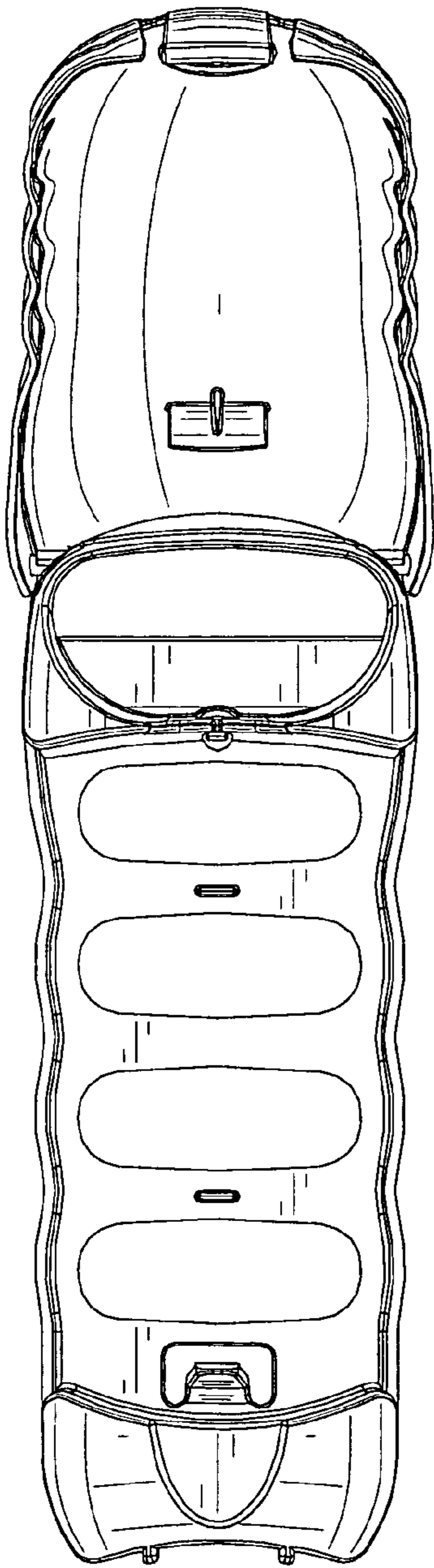

FIG. 6

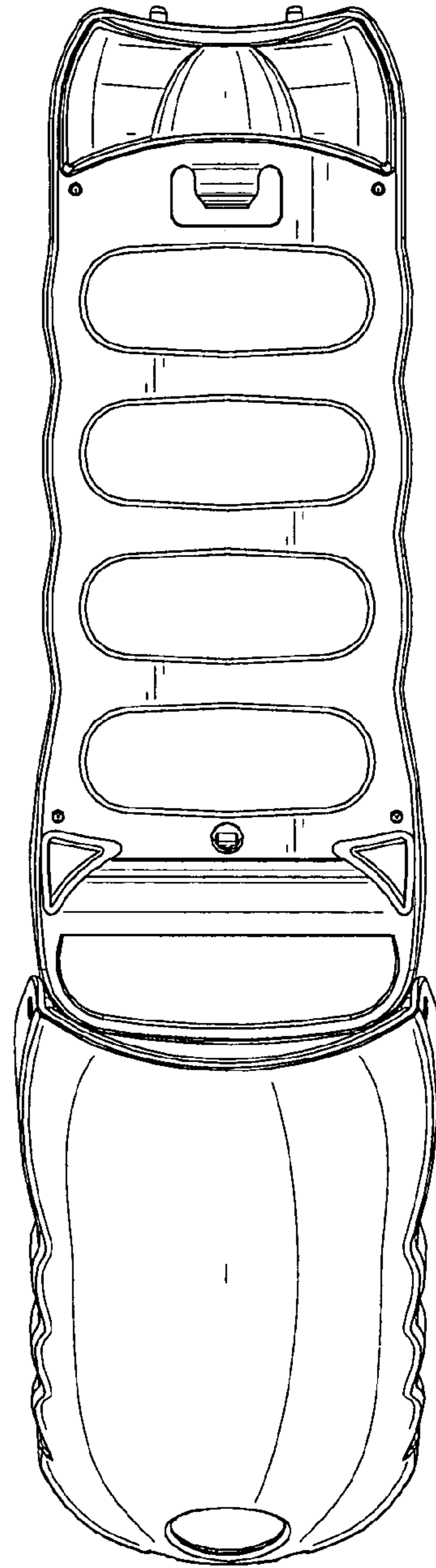

FIG. 7

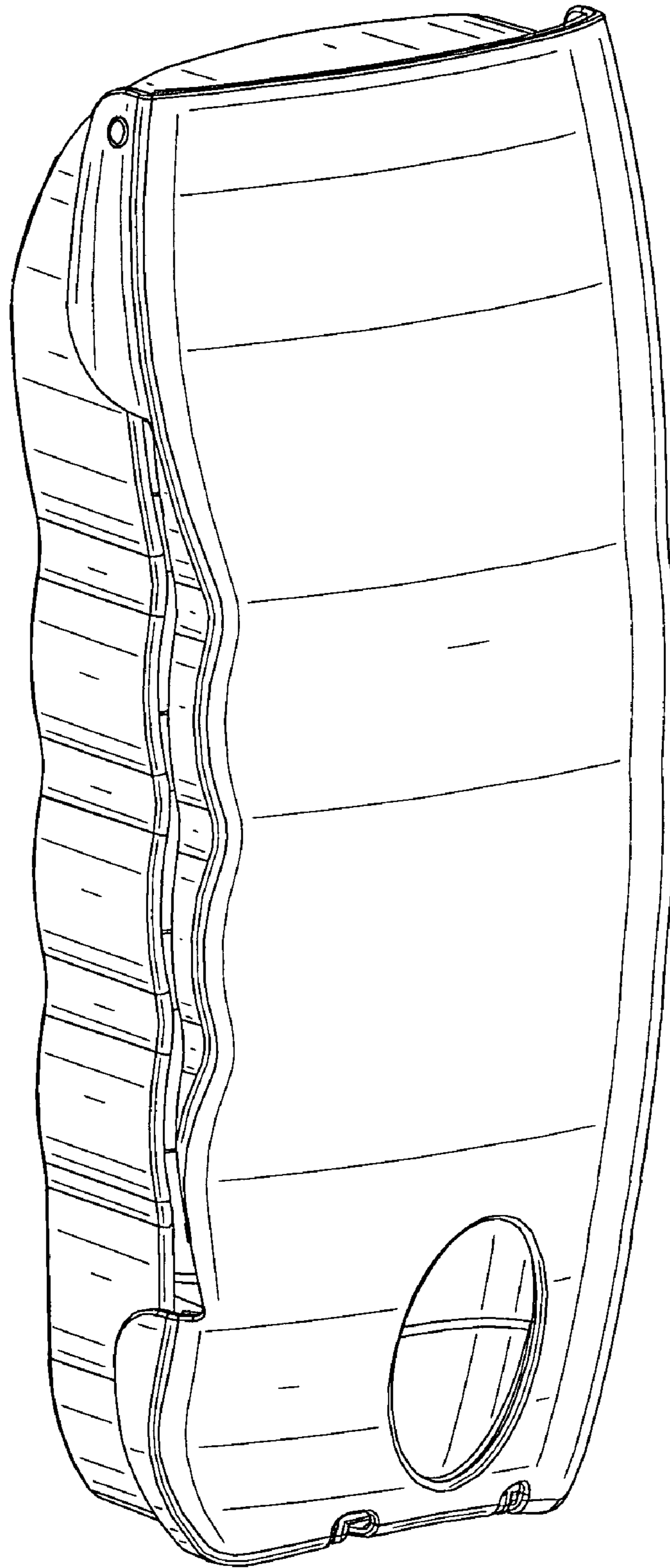

FIG. 8

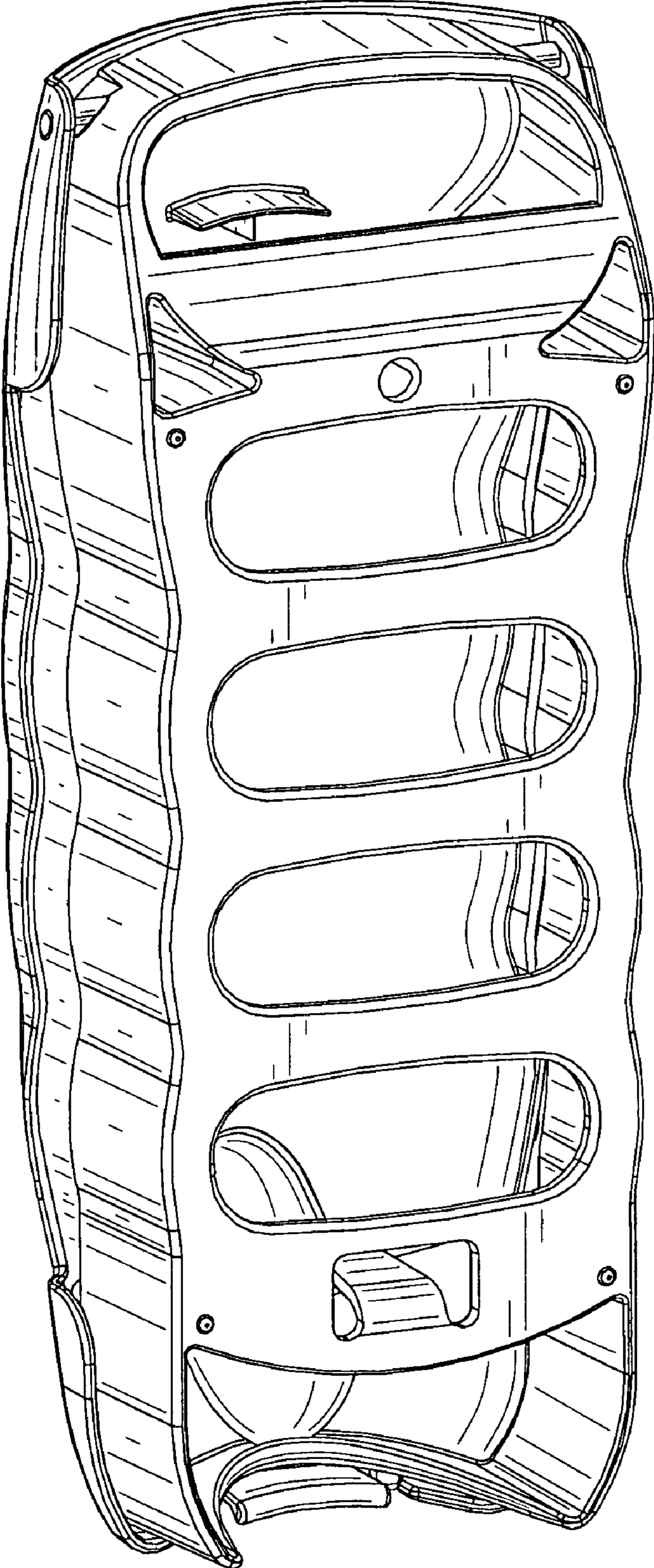

FIG. 9

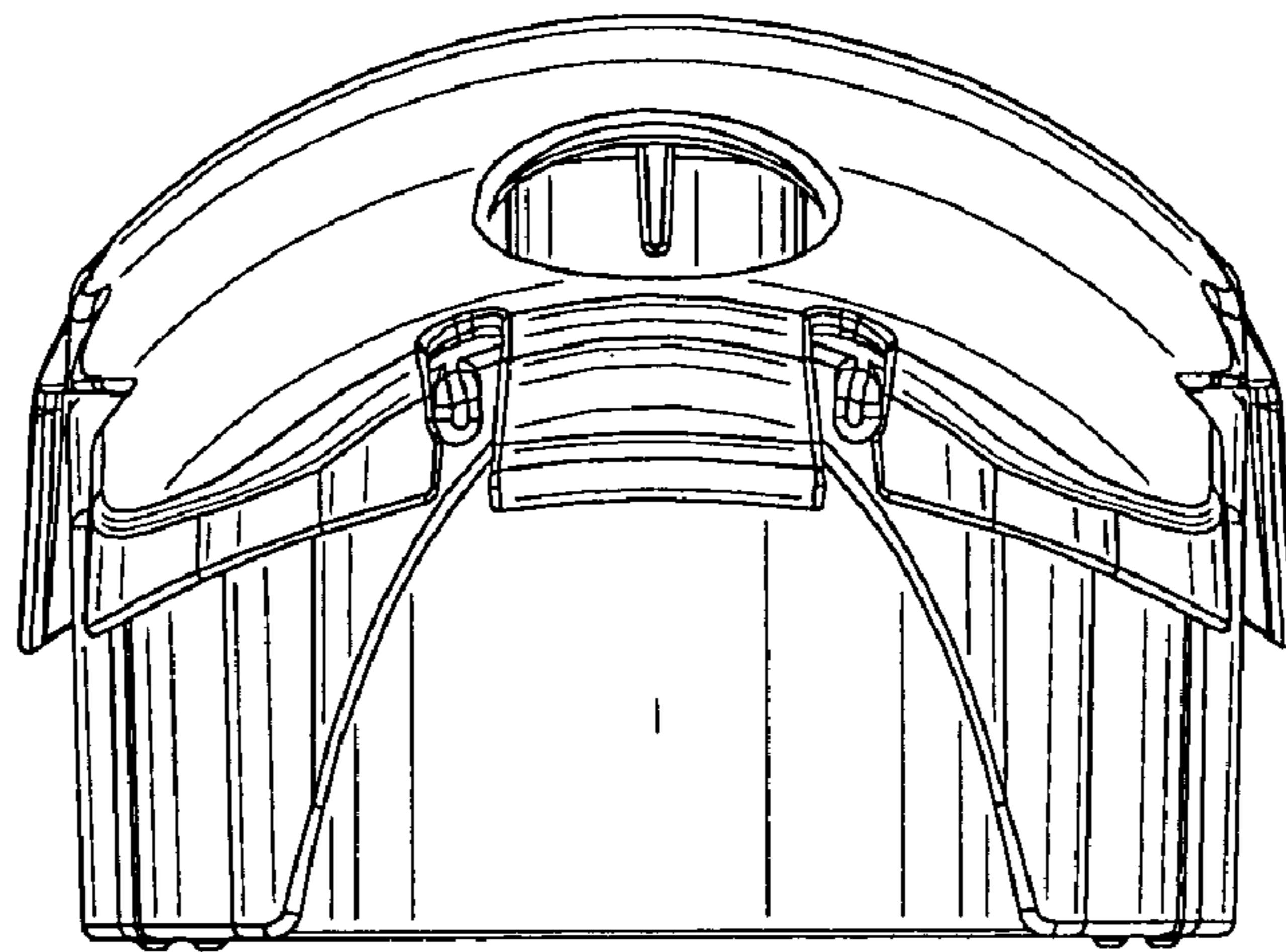

FIG. 10

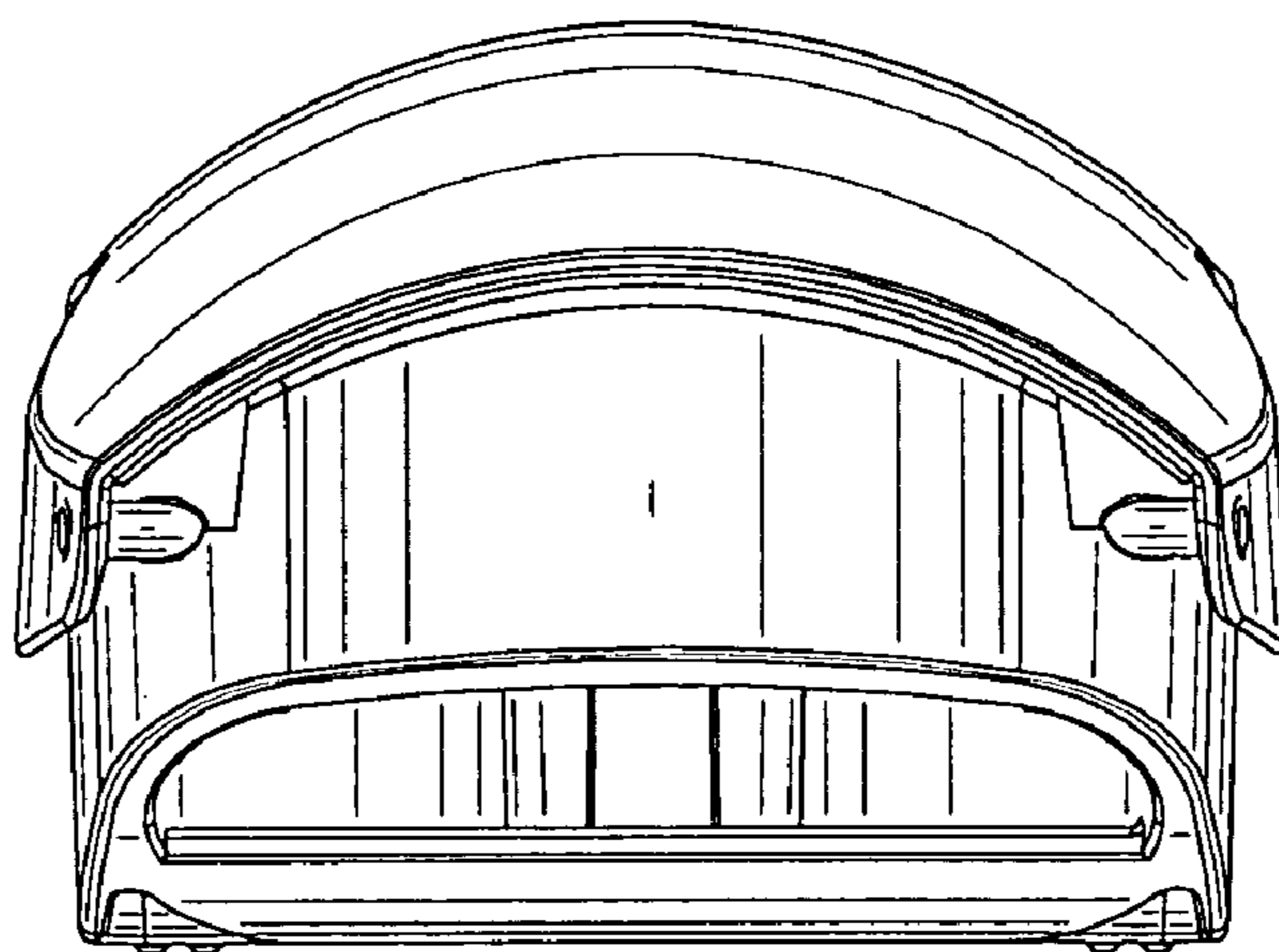

FIG. 11

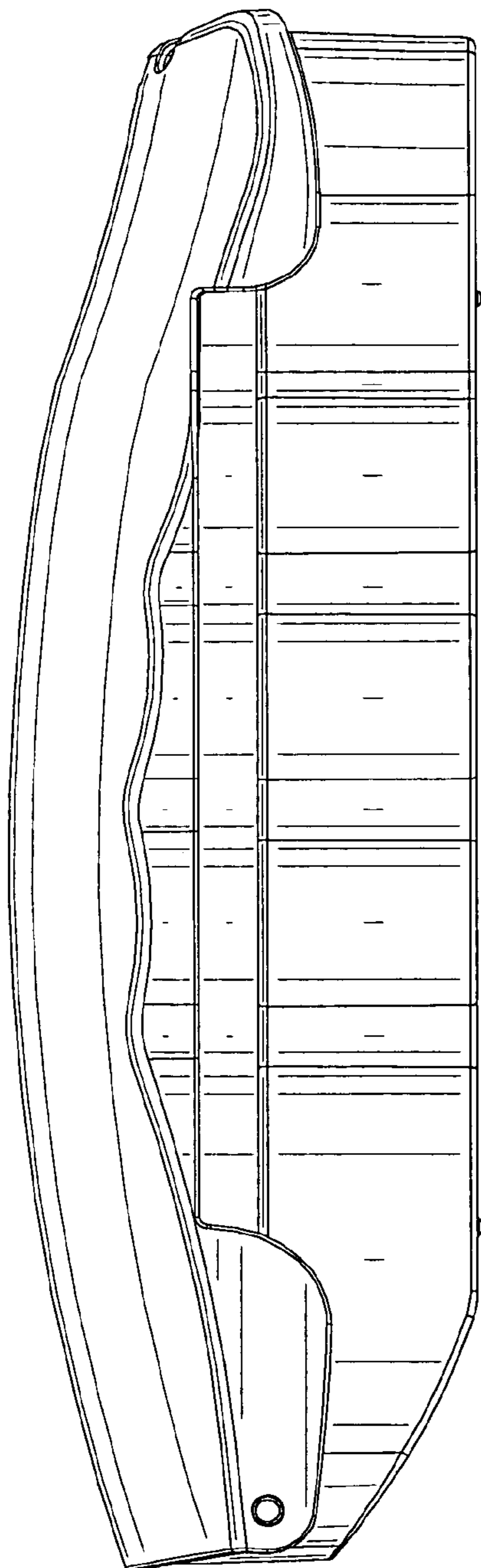

FIG. 12

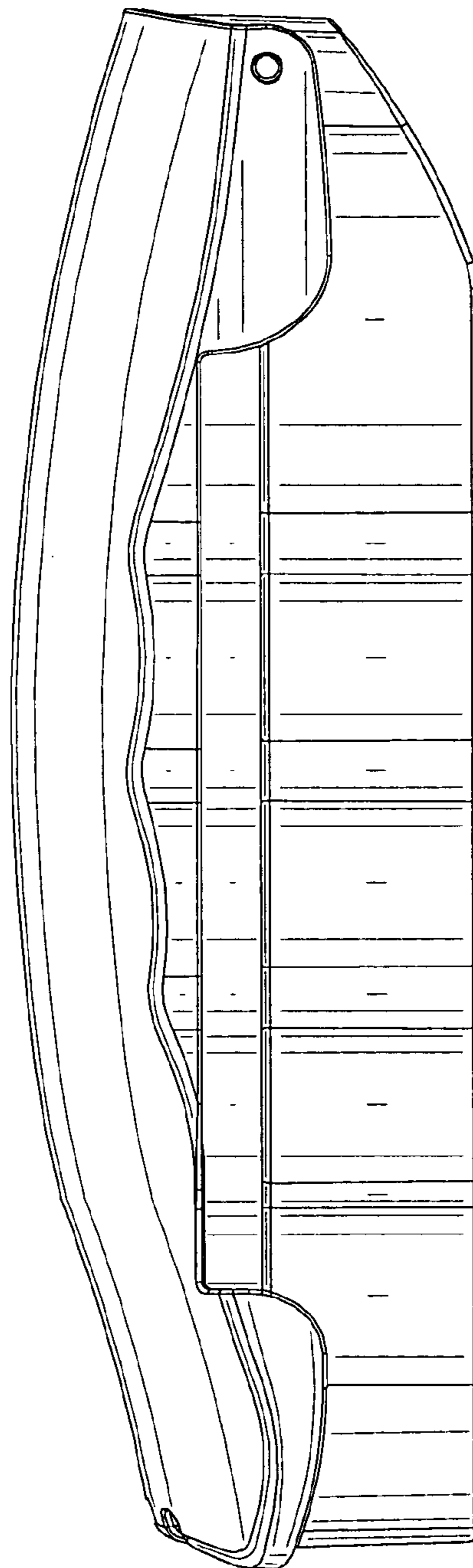

FIG. 13

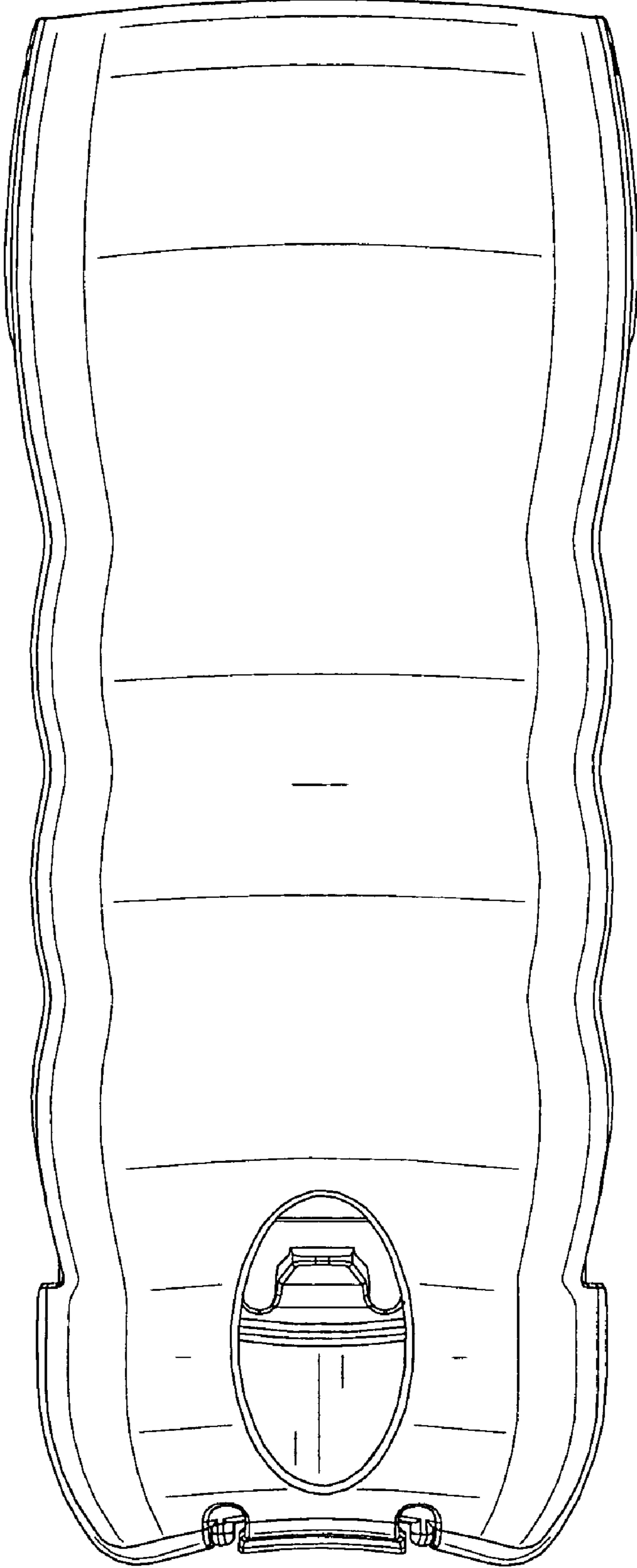

FIG. 14

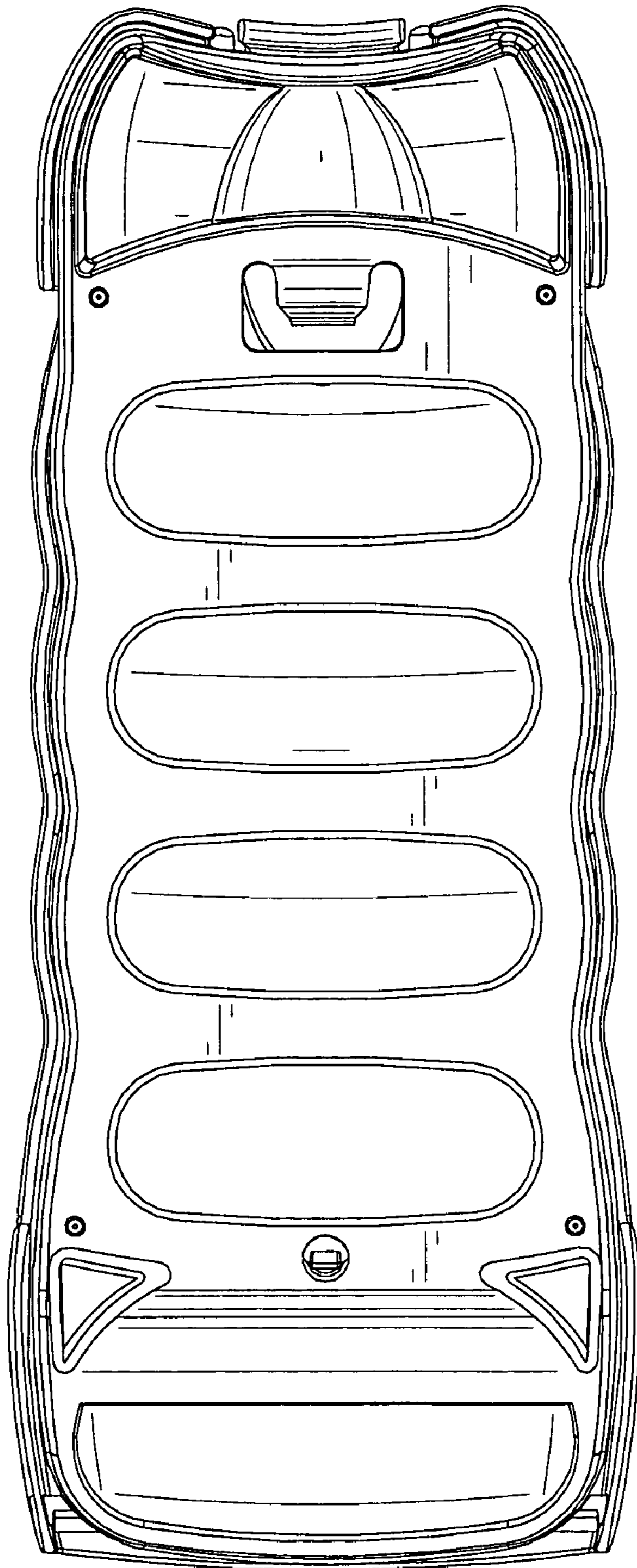

FIG. 15