

US00D596950S

(12) **United States Design Patent**  
**Nevins et al.**

(10) **Patent No.:** **US D596,950 S**

(45) **Date of Patent:** **\*\* Jul. 28, 2009**

(54) **FRAGRANCE BOTTLE**

(75) Inventors: **James Nevins**, New York, NY (US);  
**Allan E. Hafkin**, Plainview, NY (US);  
**Teresa W. Yeung**, Brooklyn, NY (US)

(73) Assignee: **Dafu Licensing, Inc.**, Los Angeles, CA  
(US)

(\*\*) Term: **14 Years**

(21) Appl. No.: **29/299,471**

(22) Filed: **Dec. 27, 2007**

(51) **LOC (9) Cl.** ..... **09-01**

(52) **U.S. Cl.** ..... **D9/690**; D9/691

(58) **Field of Classification Search** ..... D9/600-681,  
D9/682-694, 500-505; 215/6, 10, 382; 220/377,  
220/602, 662, 665, 669, 4.11, 4.26, 4.27,  
220/23.83, 23.86; 222/631, 635, 206, 211,  
222/212, 213, 215, 321.7-321.9, 372, 373,  
222/378, 379, 383.1, 384-386, 398, 400.7,  
222/400.8, 401, 402.1-402.25

See application file for complete search history.

(56) **References Cited**

**U.S. PATENT DOCUMENTS**

88,105 A	3/1869	Whitney	
D25,941 S	8/1896	Lindgren	
664,472 A	12/1900	Fenn	
D38,167 S	8/1906	Wintermann	
D43,239 S	11/1912	Tuttle	
D183,939 S	11/1958	Loewy	
D184,358 S	2/1959	Lagin	
2,917,766 A *	12/1959	Ciffo	206/15.2
D197,192 S	12/1963	Lorenzen	
3,143,250 A	8/1964	Pengue	
3,198,400 A	8/1965	Roehrich	
D208,885 S *	10/1967	Roehrich	D9/503
D212,525 S *	10/1968	Kneapler	D9/500
D220,248 S	3/1971	Blumenthal	
D223,437 S	4/1972	Lluch	
3,963,150 A *	6/1976	Steiman et al.	222/211
D244,256 S	5/1977	Dekker	

D268,897 S	5/1983	du Cret
D270,238 S	8/1983	Vilval
D291,179 S	8/1987	Frizon
D328,025 S	7/1992	Farricielli
D339,292 S	9/1993	Fareri et al.

(Continued)

**FOREIGN PATENT DOCUMENTS**

EP 000050141-0003 \* 7/2003

(Continued)

**OTHER PUBLICATIONS**

[http://www.fragrancenet.com/f/net/wf\\_items.html?cat=01112&cur\\_letter=H&gs\\_gen=W&id=ZbEMpjmR](http://www.fragrancenet.com/f/net/wf_items.html?cat=01112&cur_letter=H&gs_gen=W&id=ZbEMpjmR); May 7, 2007.

(Continued)

*Primary Examiner*—Catherine Tuttle  
(74) *Attorney, Agent, or Firm*—Cynthia R. Miller

(57) **CLAIM**

The ornamental design for a fragrance bottle, as shown and described.

**DESCRIPTION**

FIG. 1 is a top, front, right side perspective view of our new design for a fragrance bottle;

FIG. 2 is a front elevation view of the fragrance bottle shown in FIG. 1;

FIG. 3 is a right side elevation view of the fragrance bottle shown in FIG. 1, the left side being a mirror image thereof;

FIG. 4 is a rear elevation view of the fragrance bottle shown in FIG. 1;

FIG. 5 is a top plan view of the fragrance bottle shown in FIG. 1; and,

FIG. 6 is a bottom plan view of the fragrance bottle.

**1 Claim, 2 Drawing Sheets**

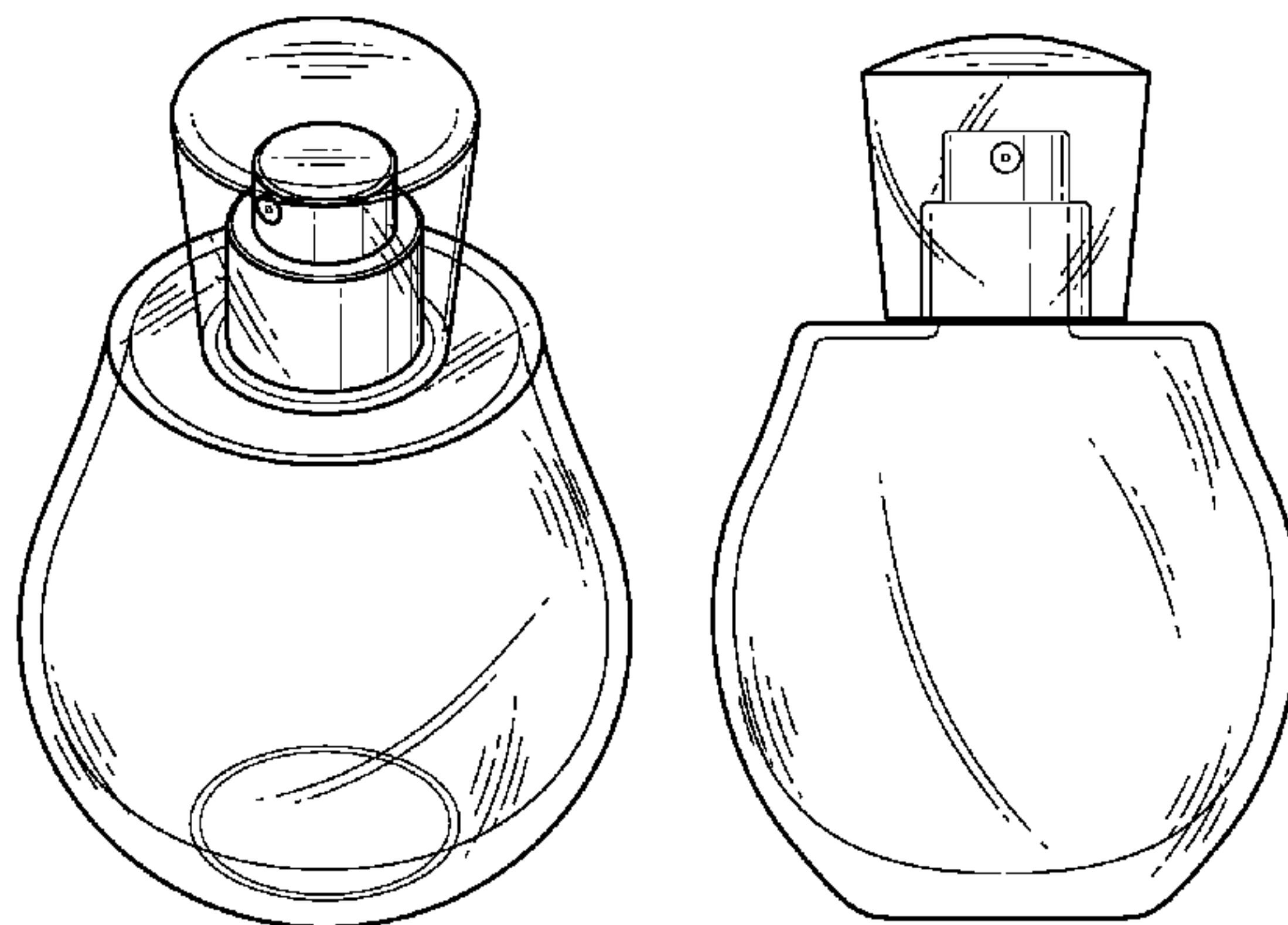

# US D596,950 S

Page 2

## U.S. PATENT DOCUMENTS

D345,914 S 4/1994 Fareri et al.  
D345,915 S 4/1994 Fareri et al.  
D354,441 S 1/1995 Fontanella  
D381,916 S 8/1997 Hundertmark et al.  
D390,470 S 2/1998 Mahlmann et al.  
D394,803 S \* 6/1998 Desgrippes ..... D9/532  
D414,684 S 10/1999 Usui et al.  
D423,360 S 4/2000 Hirato et al.  
D425,785 S 5/2000 Hirato et al.  
D434,314 S 11/2000 Vignon  
D446,121 S 8/2001 Maddy  
D449,516 S \* 10/2001 Modjeski ..... D9/692  
D449,517 S 10/2001 Vignon  
D449,777 S 10/2001 Vignon  
6,401,984 B1 \* 6/2002 Jumel ..... 222/183  
D460,693 S 7/2002 Flowers  
D463,263 S 9/2002 Gobe  
D463,735 S 10/2002 Gobe  
D472,147 S 3/2003 Herrmann  
D477,535 S 7/2003 Thorpe  
D485,182 S \* 1/2004 Gaydon ..... D9/504  
D487,697 S 3/2004 Rosen

D496,207 S 9/2004 Wang  
D497,795 S 11/2004 Fling et al.  
D507,188 S 7/2005 Chen  
D519,376 S 4/2006 Ames  
D529,805 S 10/2006 Cadena  
D570,690 S \* 6/2008 McGuinness ..... D9/504  
D576,880 S \* 9/2008 Couey ..... D9/503  
2006/0289537 A1 12/2006 Ficcadenti

## FOREIGN PATENT DOCUMENTS

EP 000204573-0006 \* 7/2004  
GB DES. 2069106 9/1997  
GB DES. 2096755 10/2000  
GB DES. 3015322 11/2003  
WO DM/063943 \* 7/2003

## OTHER PUBLICATIONS

<http://www.gnpd.com>; Glow Women's Fragrance; Record ID: 334012; Lancaster; J.Lo; Frangrances; Women's Frangrances, Australia; Jan. 1, 2005.

<http://www.gnpd.com>; Eau de Parfum; Record ID: 373147; Jajado; Jajado; Frangrances; Women's Frangrances; Vietnam; Jun. 30, 2005.

\* cited by examiner

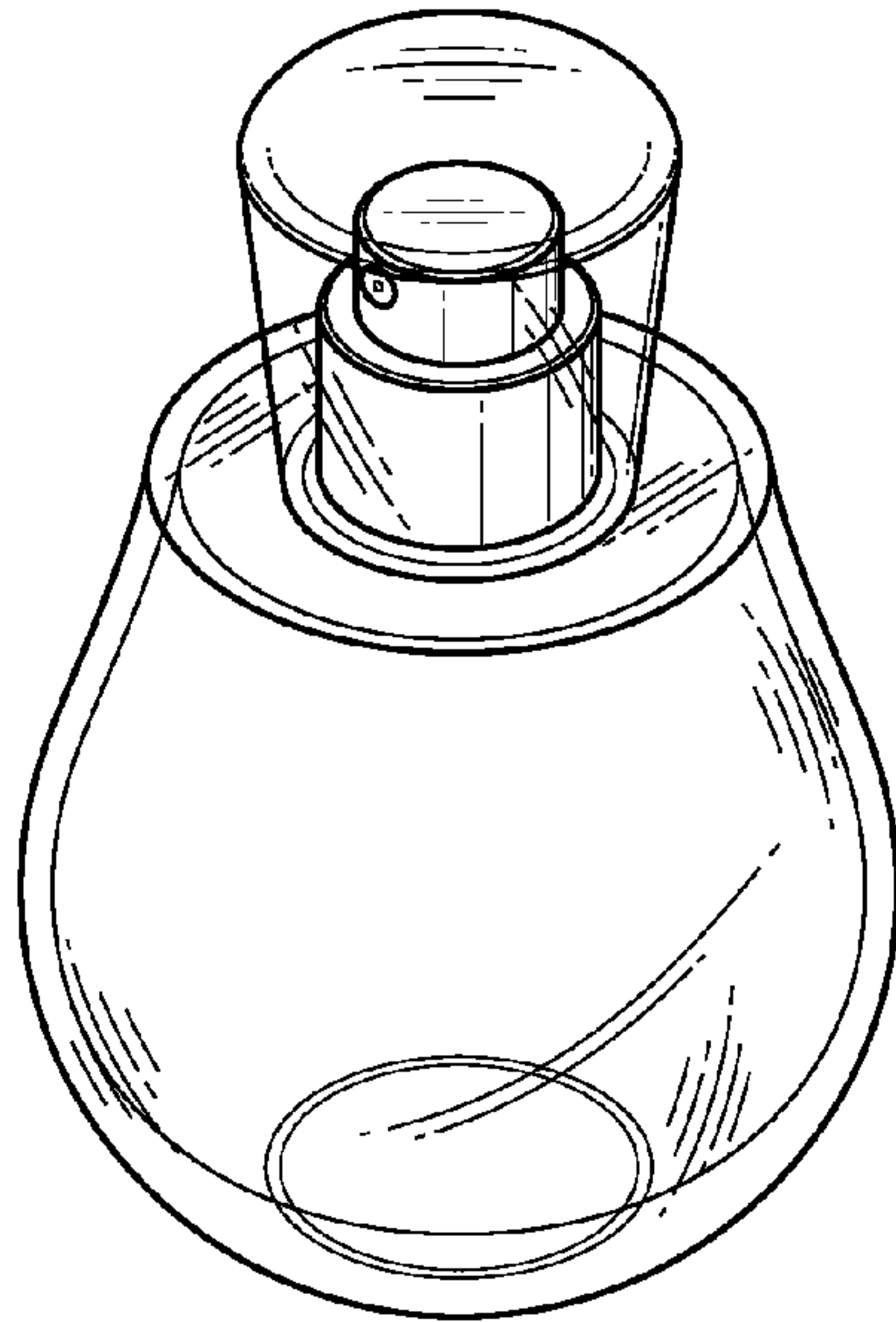

FIG. 1

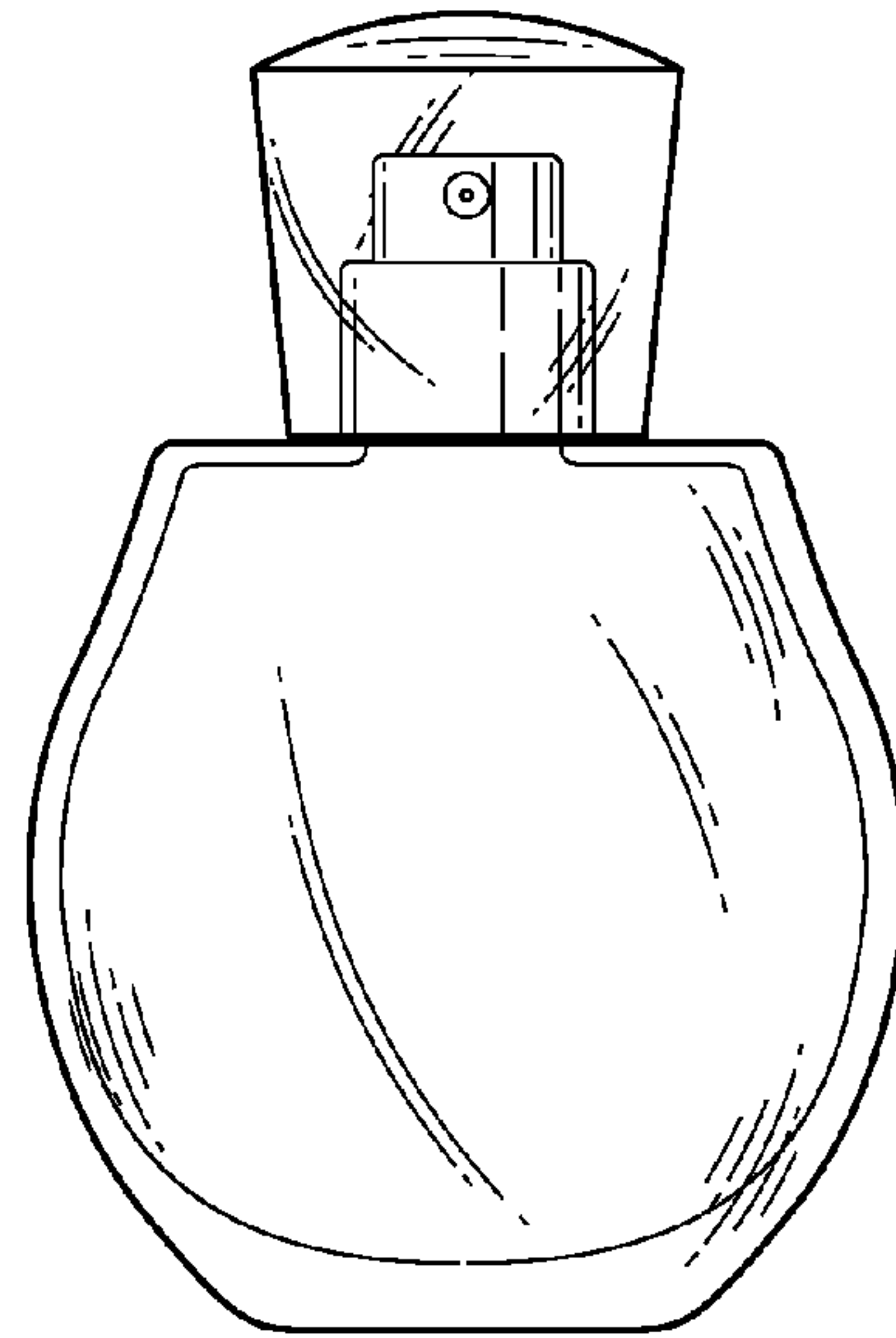

FIG. 2

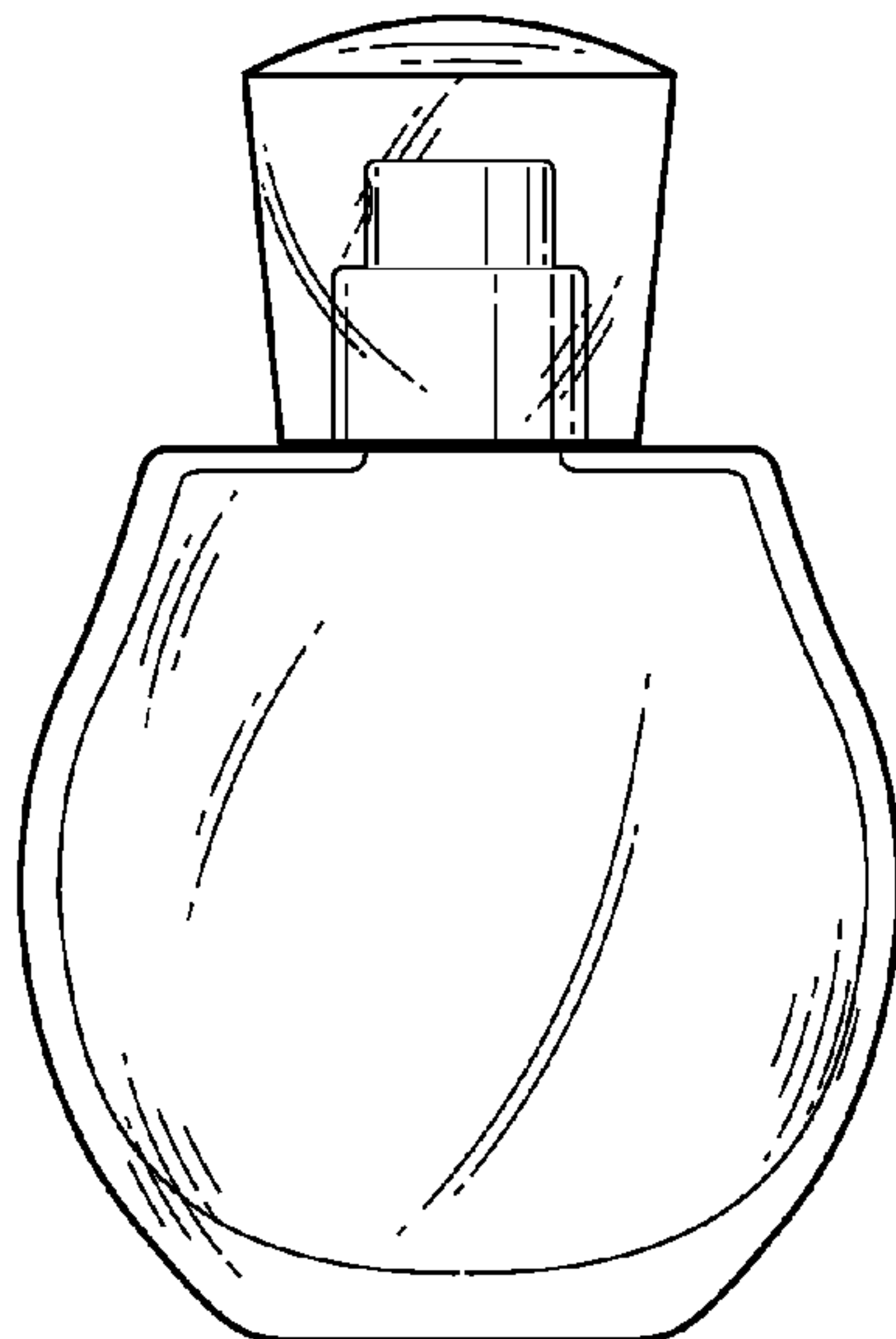

FIG. 3

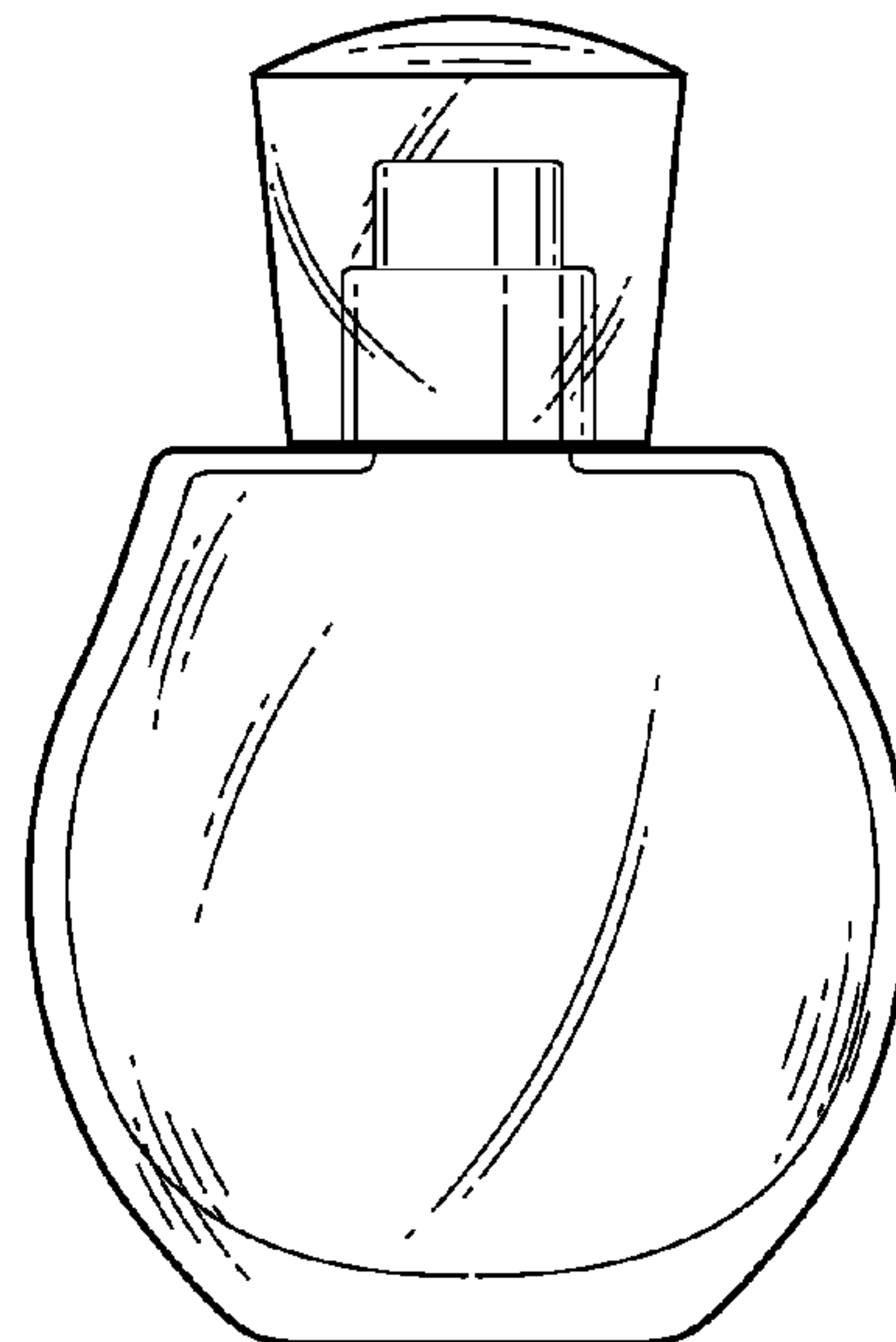

FIG. 4

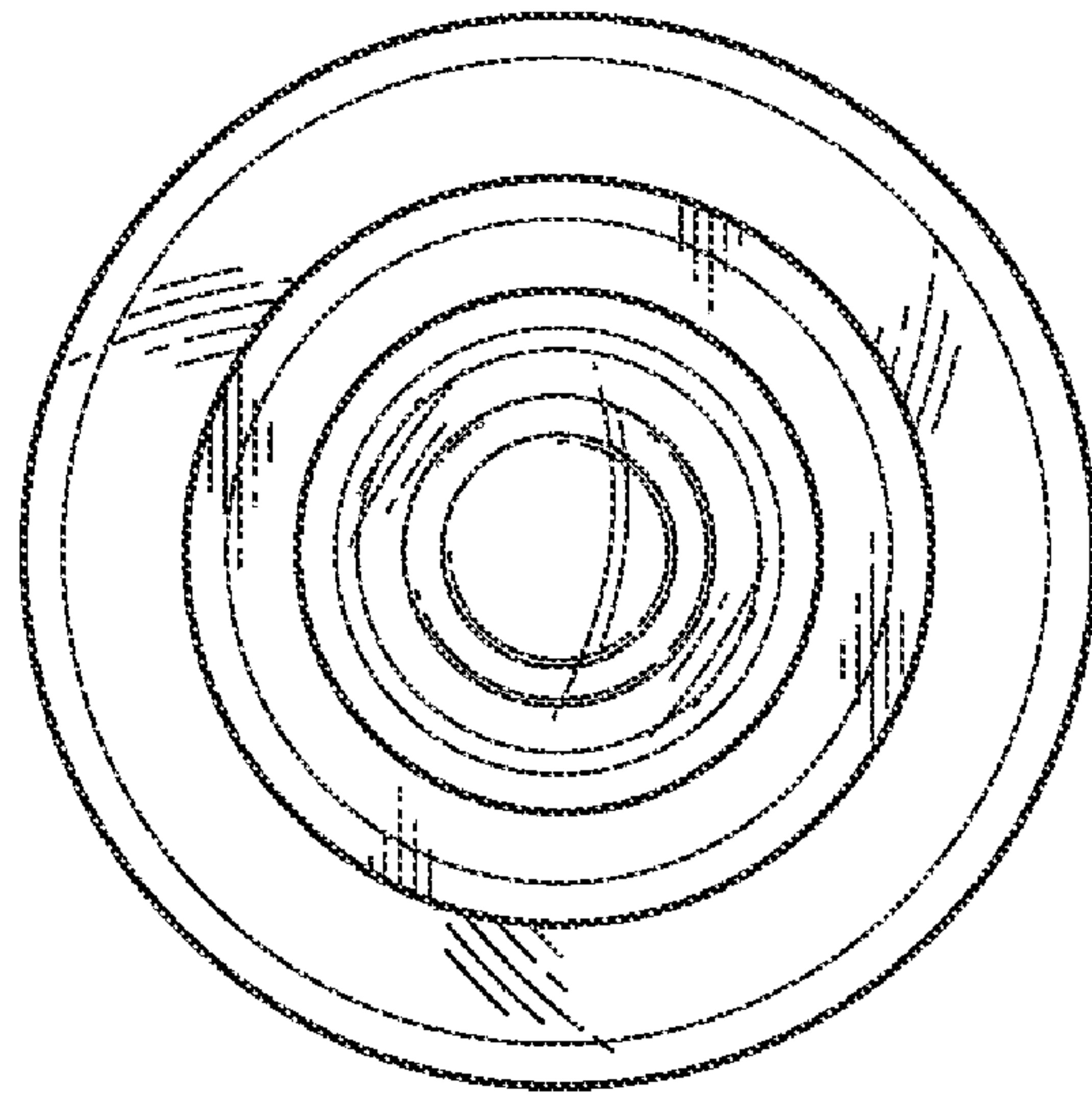

FIG. 5

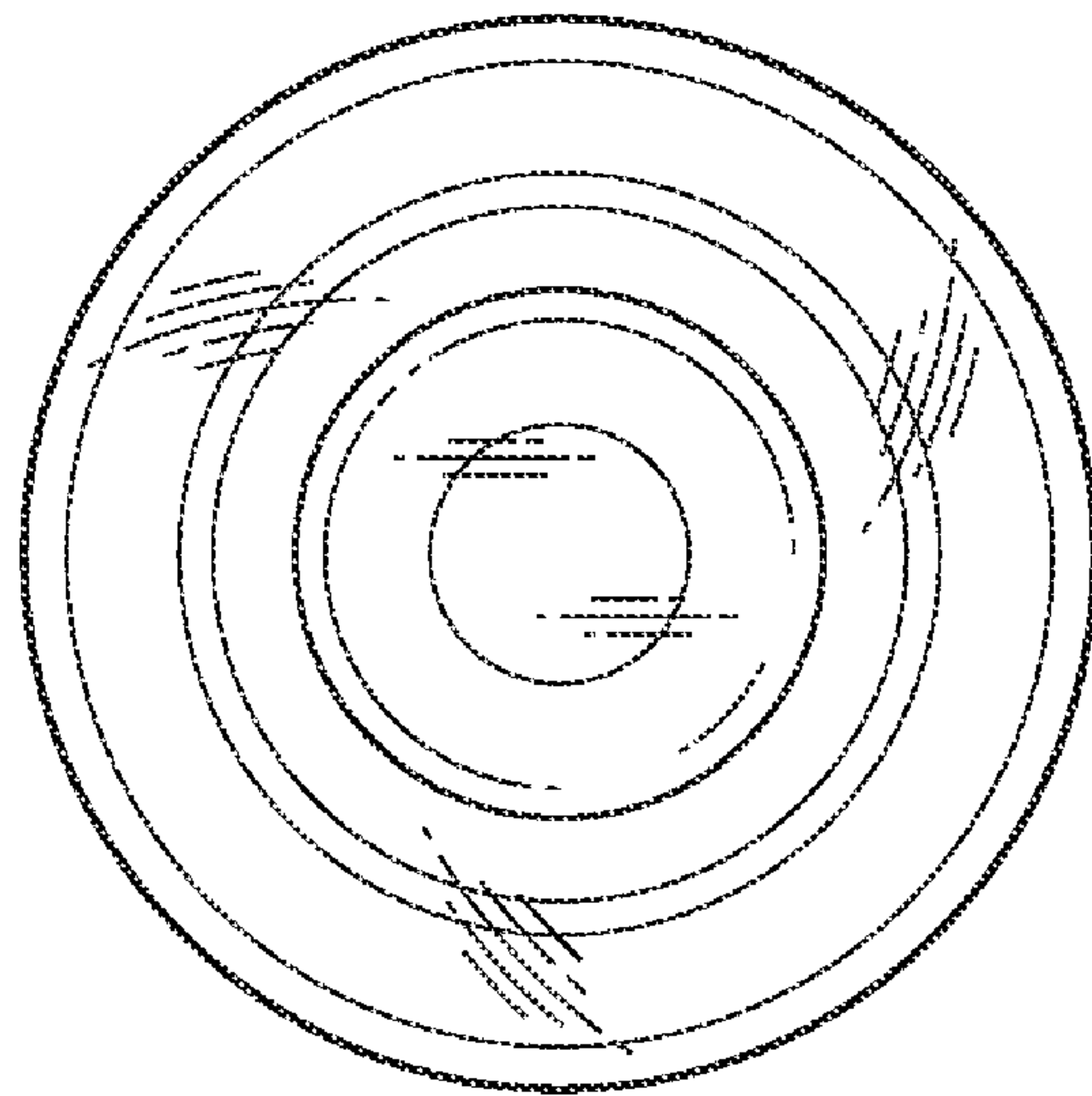

FIG. 6