



US00D596911S

(12) **United States Design Patent**  
**Carpenter et al.**

(10) **Patent No.:** **US D596,911 S**  
(45) **Date of Patent:** **\*\* Jul. 28, 2009**

(54) **FOLDING MULTIPURPOSE HAND TOOL**

(75) Inventors: **Jason C. Carpenter**, Battle Ground, WA (US); **Jeffrey B. Castro**, Portland, OR (US)

(73) Assignee: **Leatherman Tool Group, Inc.**, Portland, OR (US)

(\*\*) Term: **14 Years**

(21) Appl. No.: **29/327,869**

(22) Filed: **Nov. 14, 2008**

(51) **LOC (9) Cl.** ..... **05-02**

(52) **U.S. Cl.** ..... **D8/55; D8/105**

(58) **Field of Classification Search** ..... D8/4,  
D8/5, 51-56, 58, 70, 71, 81, 104-107; 81/385,  
81/405, 407-409, 411, 415-418, 326, 424.5,  
81/427.5, 426, 427, 300, 318, 329, 342, 393;  
D24/133, 148, 153; D22/149, 150; 7/125-128,  
7/137

See application file for complete search history.

(56) **References Cited**

**U.S. PATENT DOCUMENTS**

D352,436 S *	11/1994	Abel	.....	D8/52
D406,997 S *	3/1999	Robbins	.....	D8/55
D410,369 S *	6/1999	Yeh	.....	D8/55
D426,447 S *	6/2000	Chau	.....	D8/55
6,276,063 B1 *	8/2001	Chen	.....	30/161
D505,057 S *	5/2005	Ralph	.....	D8/99
D539,631 S *	4/2007	Taylor	.....	D8/107
D557,100 S *	12/2007	Stokes et al.	.....	D8/105
D568,710 S	5/2008	Kleckner et al.		
D569,212 S *	5/2008	Hawk et al.	.....	D8/99
D571,181 S	6/2008	Kleckner et al.		
D573,437 S *	7/2008	Nenadic	.....	D8/105
D573,865 S	7/2008	Kleckner et al.		
D576,002 S *	9/2008	Barber et al.	.....	D8/22
D585,250 S *	1/2009	Lee et al.	.....	D8/5
D588,885 S *	3/2009	Barber et al.	.....	D8/22

**OTHER PUBLICATIONS**

Deutsch, S., Preview: Leatherman Freestyle; available at <http://toolmonger.com/2008/02/18/preview-leatherman-freestyle/>, dated Jul. 18, 2008, 4 pages.

(Continued)

*Primary Examiner*—Cathron C Brooks

*Assistant Examiner*—Deanna Fluegeman

(74) *Attorney, Agent, or Firm*—Alston & Bird LLP

(57) **CLAIM**

The ornamental design for a folding multipurpose hand tool, as shown and described.

**DESCRIPTION**

FIG. 1 is a perspective view of an embodiment of a folding multipurpose hand tool according to our new design shown in an open configuration;

FIG. 2 is a top plan view thereof;

FIG. 3 is a bottom plan view thereof;

FIG. 4 is a left side elevation view thereof;

FIG. 5 is a right side elevation view thereof;

FIG. 6 is a rear elevation view thereof;

FIG. 7 is a front elevation view thereof;

FIG. 8 is another perspective view thereof shown in a closed, folded configuration thereof;

FIG. 9 is a top plan view thereof;

FIG. 10 is a bottom plan view thereof;

FIG. 11 is a left side elevation view thereof;

FIG. 12 is a right side elevation view thereof;

FIG. 13 is a rear elevation view thereof; and,

FIG. 14 is a front elevation view thereof.

**1 Claim, 14 Drawing Sheets**

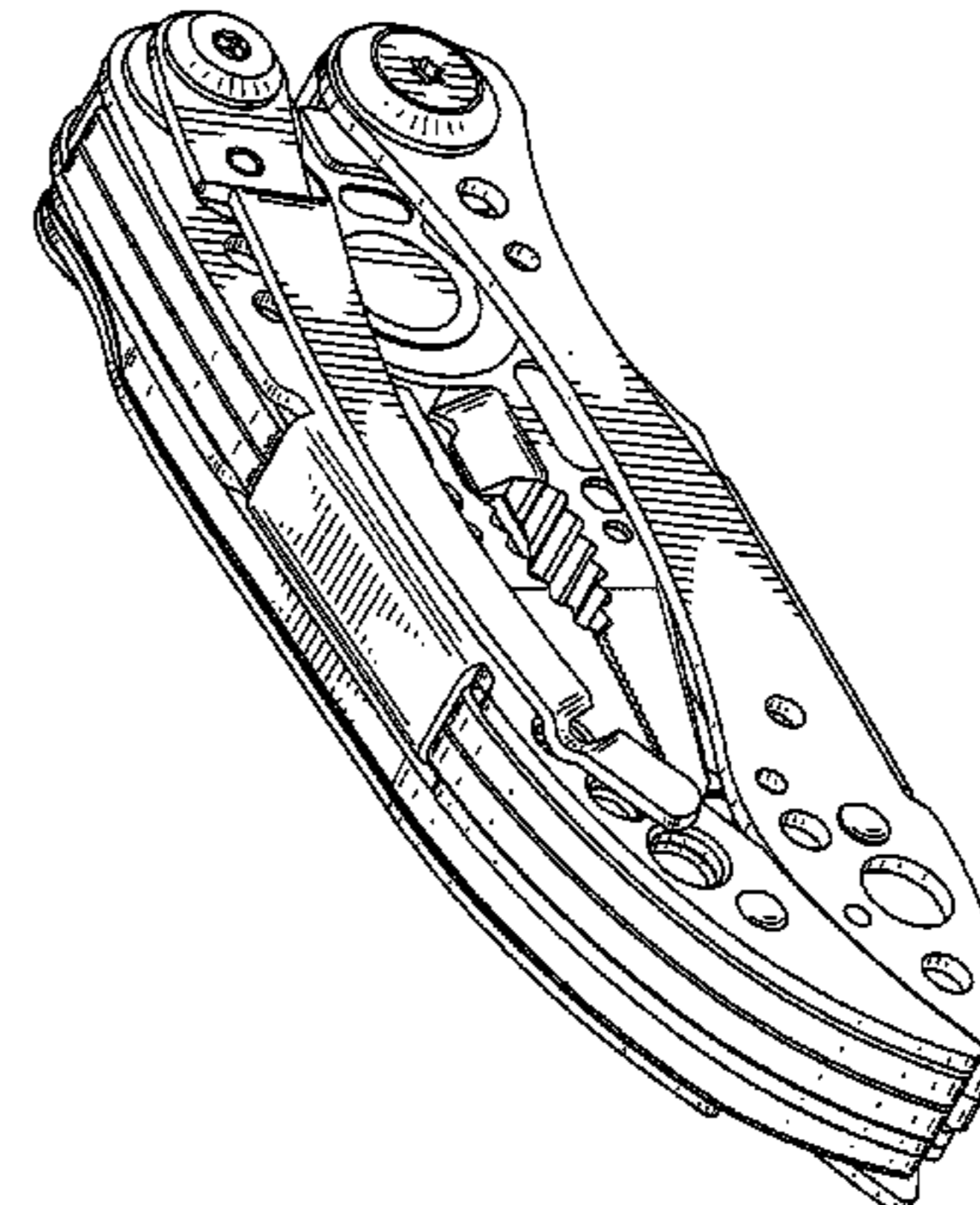
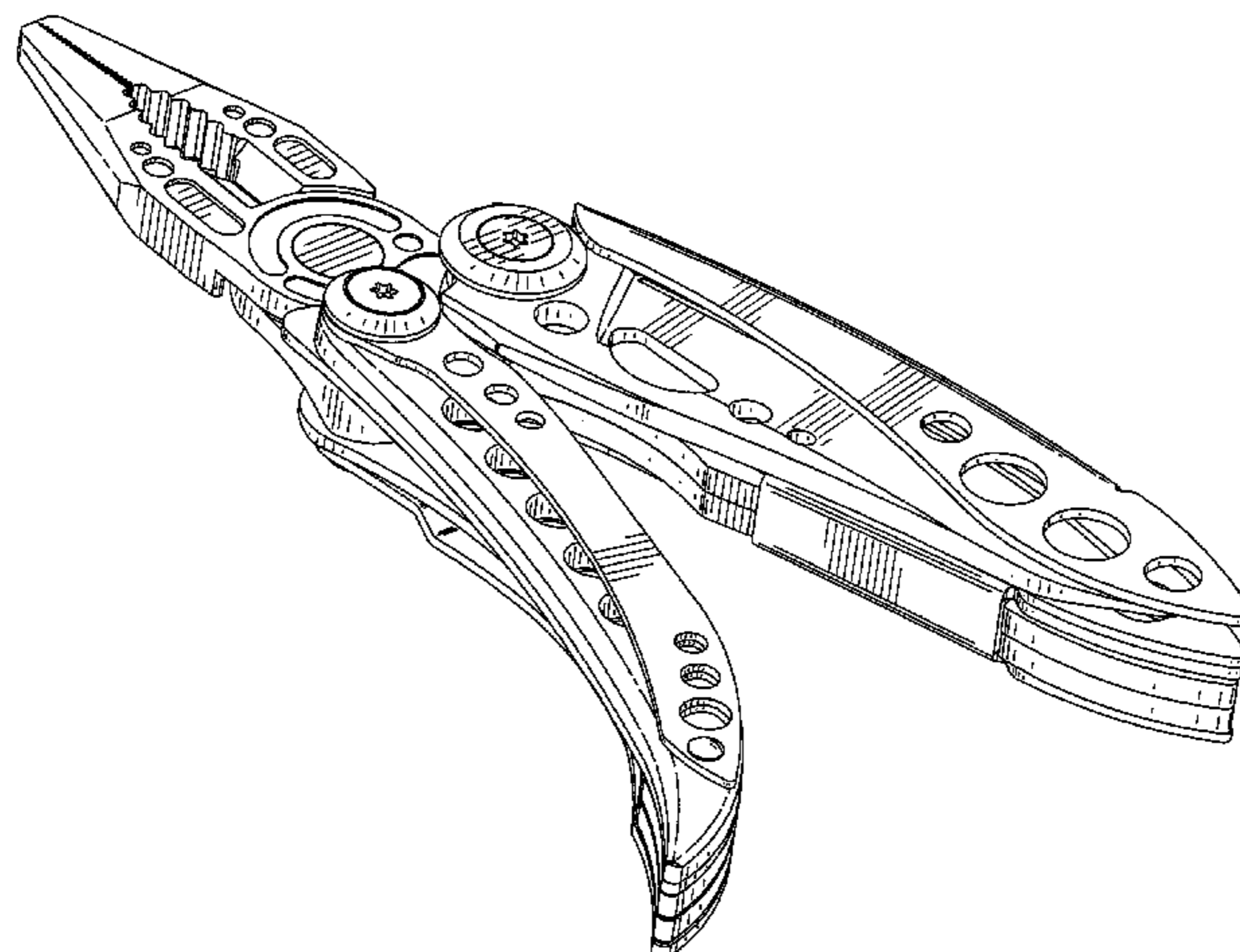

## OTHER PUBLICATIONS

[http://toolmonger.com/wp-content/uploads/2008/02/LM\\_Freestyle\\_Preview.jpg](http://toolmonger.com/wp-content/uploads/2008/02/LM_Freestyle_Preview.jpg), dated Jul. 18, 2008, 1 page.  
[http://toolmonger.com/wp-content/uploads/2008/02/LM\\_Freestyle\\_Skeletool1.jpg](http://toolmonger.com/wp-content/uploads/2008/02/LM_Freestyle_Skeletool1.jpg), dated Jul. 18, 2008, 1 page.  
Leatherman | Freestyle Tool With a Gift Tin | 830843 | B&H Photo, available at <http://www.bhphotovideo.com/c/product/511489-REG>, dated Jul. 18, 2008, 2 pages.  
<http://www.bhphotovideo.com/images/largeimages/511489.jpg>, dated Jul. 18, 2008, 1 page.  
[http://www.bhphotovideo.com/images/multiple\\_images/item\\_images/IMG\\_7174.jpg](http://www.bhphotovideo.com/images/multiple_images/item_images/IMG_7174.jpg), dated Jul. 18, 2008, 1 page.  
Johnson, J., Leatherman Freestyle: A Cheaper Skeletool, available at <http://gadgets.boingboing.net/2008/02/18/leatherman-freestyle.html>, dated Jul. 18, 2008, 3 pages.  
Shot Show 2007 Report—Knives, available at [http://www.equipped.org/shot\\_show\\_2007\\_knives4.htm](http://www.equipped.org/shot_show_2007_knives4.htm); dated Jul. 18, 2008, 10 pages.  
Leatherman Freestyle Rendering, available at <http://www.equipped.org/pp/pic1902.htm>, dated Jul. 18, 2008, 1 page.  
Leatherman Freestyle Bit Storage, available at <http://www.equipped.org/pp/pic1916.htm>, dated Jul. 18, 2008, 1 page.  
Leatherman Freestyle, available at <http://www.equipped.org/pp/pic1891.htm>, dated Jul. 18, 2008, 1 page.  
Leatherman Freestyle, available at <http://www.equipped.org/pp/pic1893.htm>, dated Jul. 18, 2008, 1 page.  
Leatherman Freestyle—Knifeforums.com, available at <http://www.knifeforums.com/forums/showtopic.php?tid/786138/>, dated Jul. 18, 2008, 3 pages.

ESPN.com—Day two new products unveiled, available at <http://sports.espn.go.com/espn/print?id=2730032&type=story>, dated Jul. 18, 2008, 1 page.  
Leatherman Freestyle: Lighter Tools In Your Pocket—Homotron.net, available at [http://www.homotron.net/2008/02/leatherman\\_freestyle\\_lighter\\_t.html](http://www.homotron.net/2008/02/leatherman_freestyle_lighter_t.html), dated Jul. 18, 2008, 2 pages.  
[http://www.camping-gear-outlet.com/images/product/7\\_87718.jpg](http://www.camping-gear-outlet.com/images/product/7_87718.jpg), dated Jul. 18, 2008, 1 page.  
Skeletool (production model) 2 pages.  
<http://raduborcea.files.wordpress.com/2008/05/skeletool-cx-diagram.jpg>, dated Jul. 18, 2008, 1 page.  
<http://www.vikingchalet.com/~server/images/stories/skeletool-detail.jpg>, dated Jul. 18, 2008, 1 page.  
[http://toolmonger.com/wp-content/uploads/2007/09/TM\\_Leatherman\\_Skeletool.jpg](http://toolmonger.com/wp-content/uploads/2007/09/TM_Leatherman_Skeletool.jpg), dated Jul. 18, 2008, 1 page.  
[http://toolmonger.com/wp-content/uploads/2008/02/Skeletool\\_Beauty.jpg](http://toolmonger.com/wp-content/uploads/2008/02/Skeletool_Beauty.jpg), dated Jul. 18, 2008, 1 page.  
[http://www.linux-mag.com/images/2007-12/gift-guide/Skeletool\\_CX\\_Beauty.jpg](http://www.linux-mag.com/images/2007-12/gift-guide/Skeletool_CX_Beauty.jpg), dated Jul. 18, 2008, 1 page.  
<http://www.gearcrave.com/wp-content/uploads/2007/11/skeletool.jpg>, dated Jul. 18, 2008, 1 page.  
<http://knivesandmultitools.com/library/SkeletoolCX.JPG>, dated Jul. 18, 2008, 1 page.  
Leatherman Freestyle, available at <http://www.equipped.org/pp/pic1892.htm>, dated Jul. 18, 2008, 1 page.

\* cited by examiner



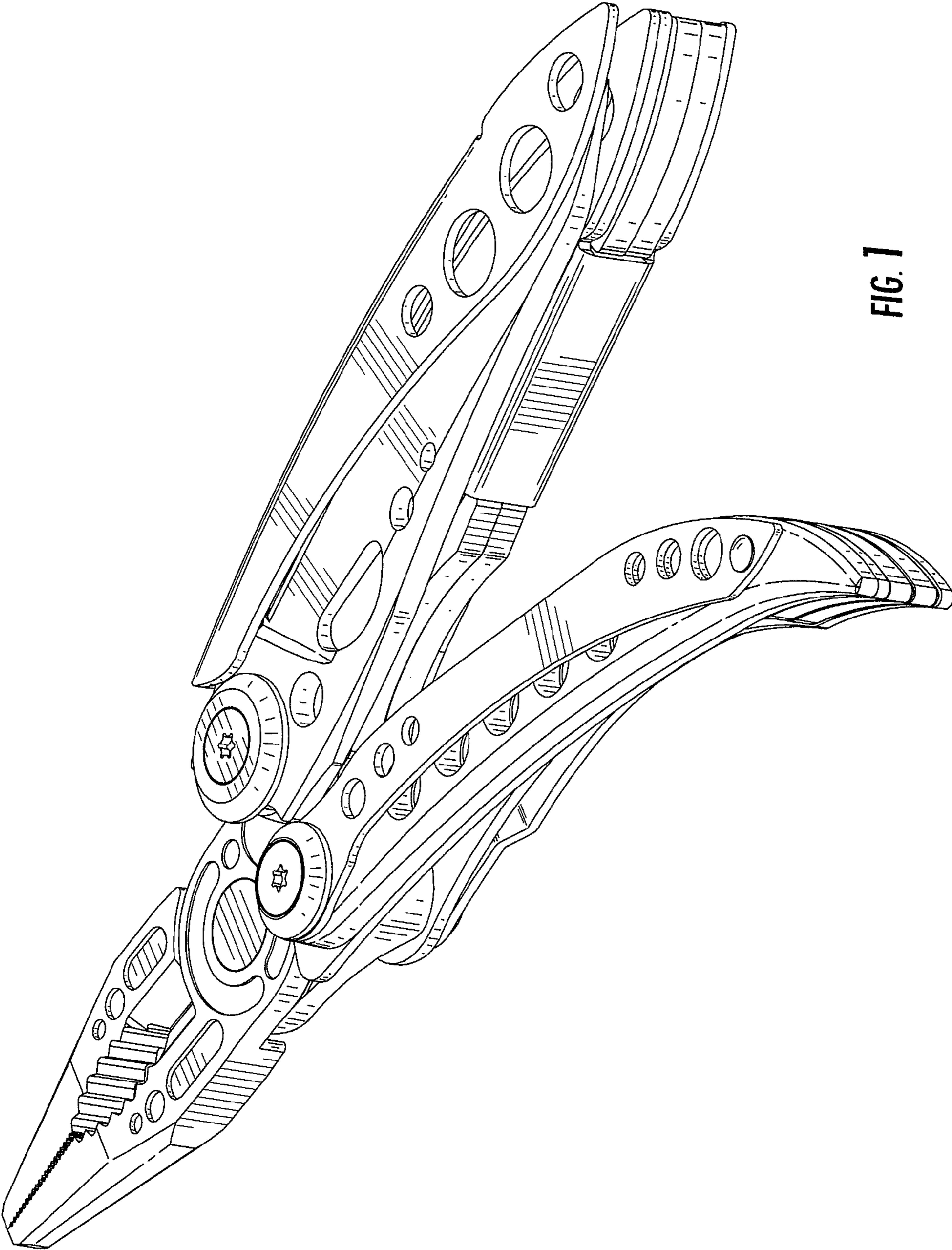

FIG. 1

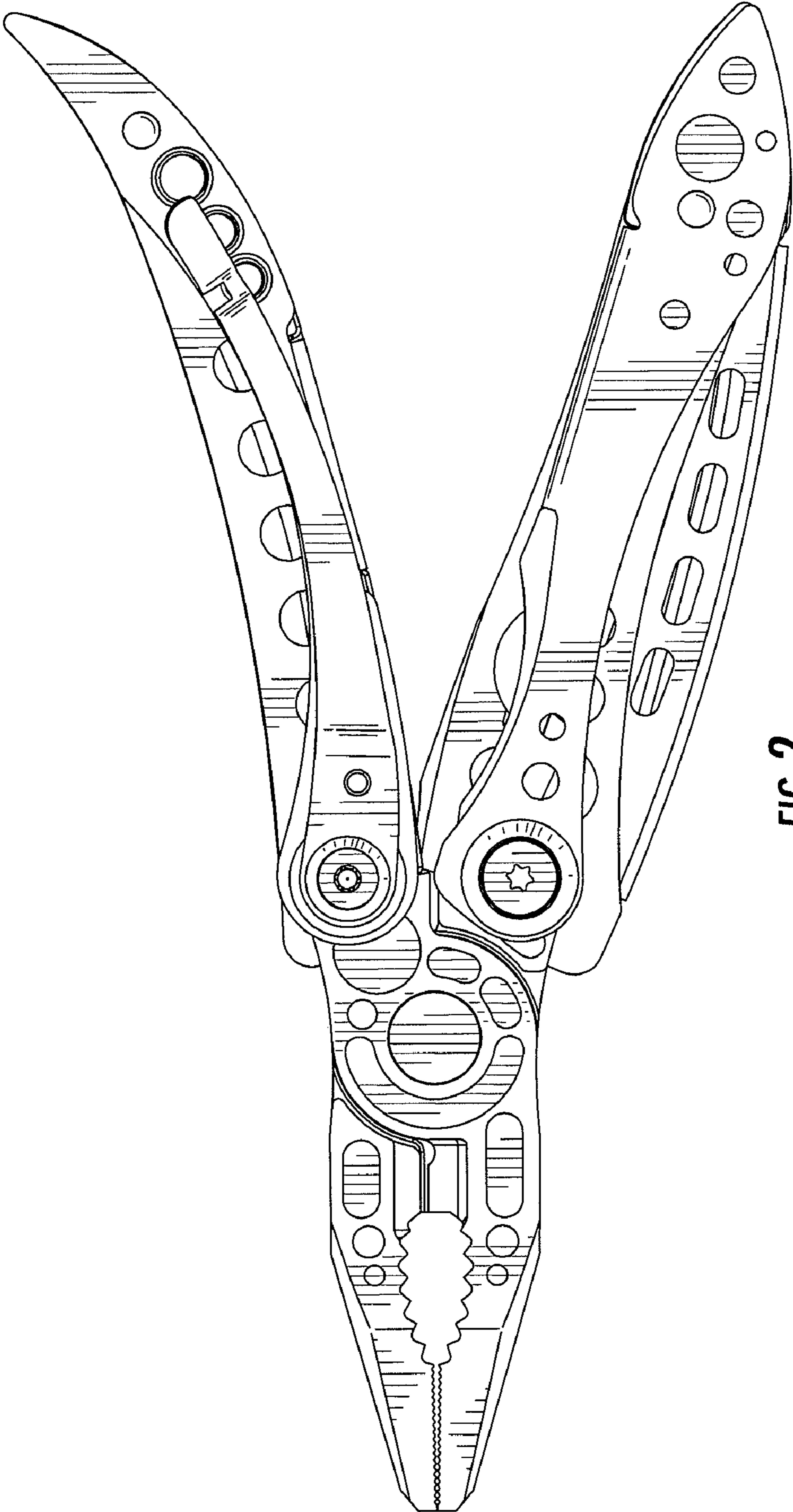

FIG. 2

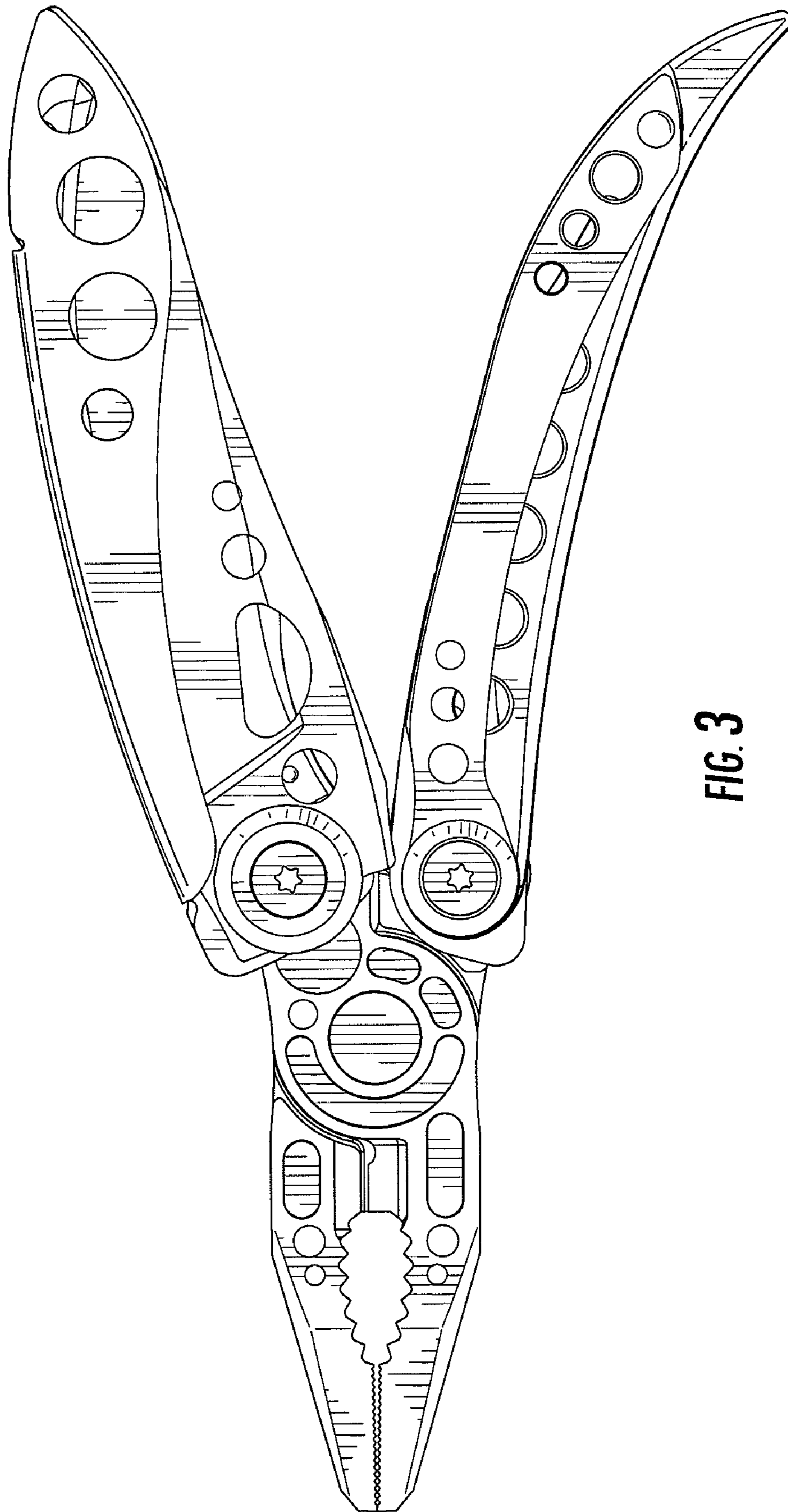

FIG. 3

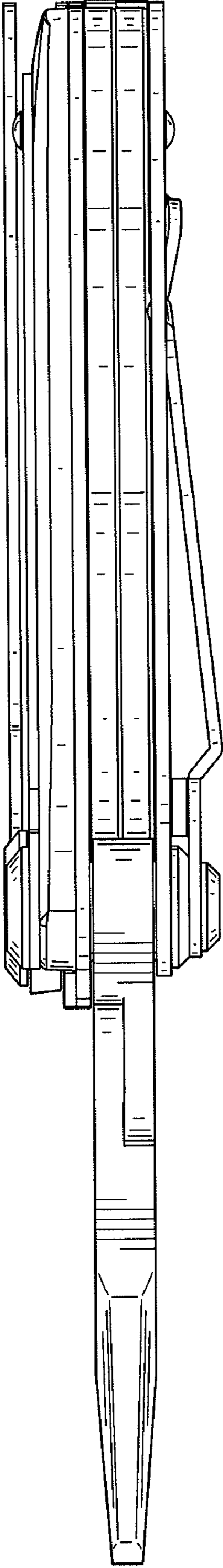

FIG. 4

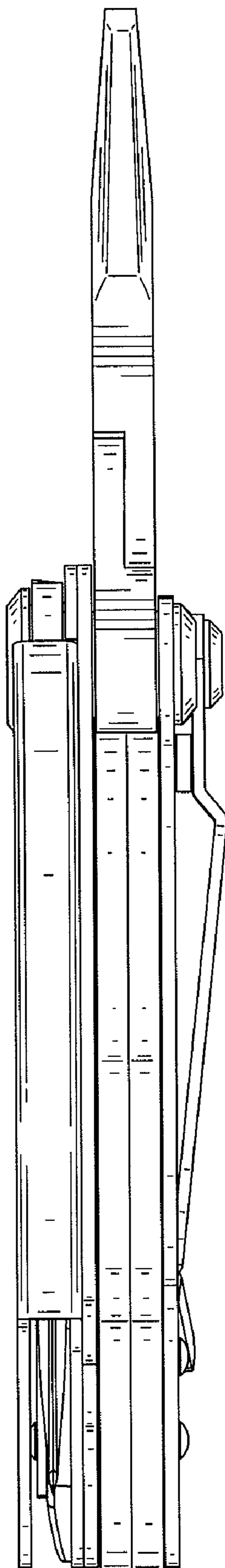
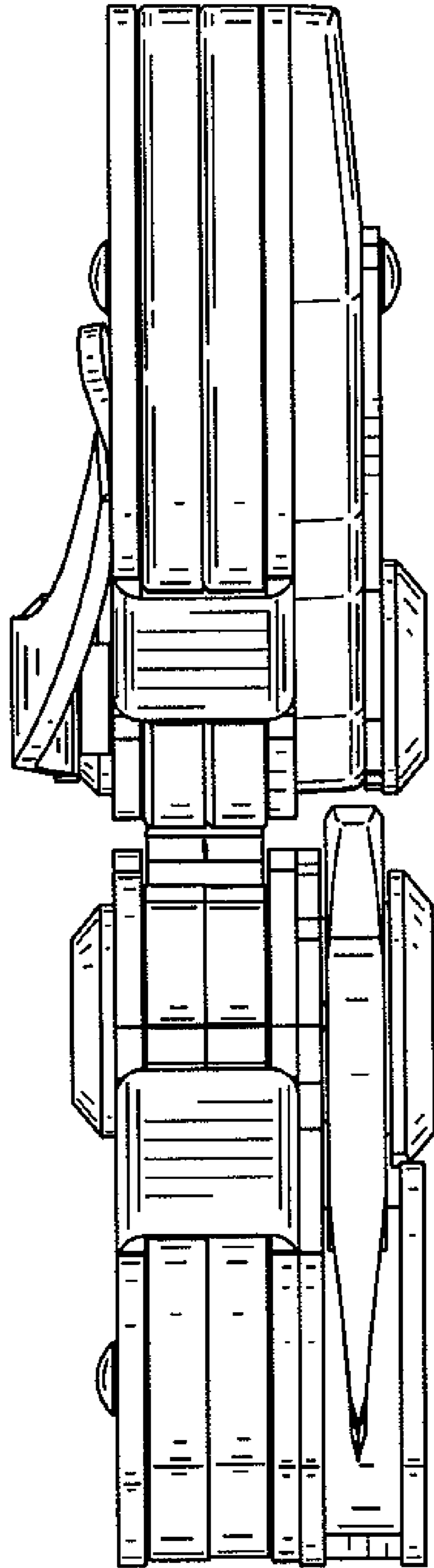

FIG. 5



**FIG. 6**



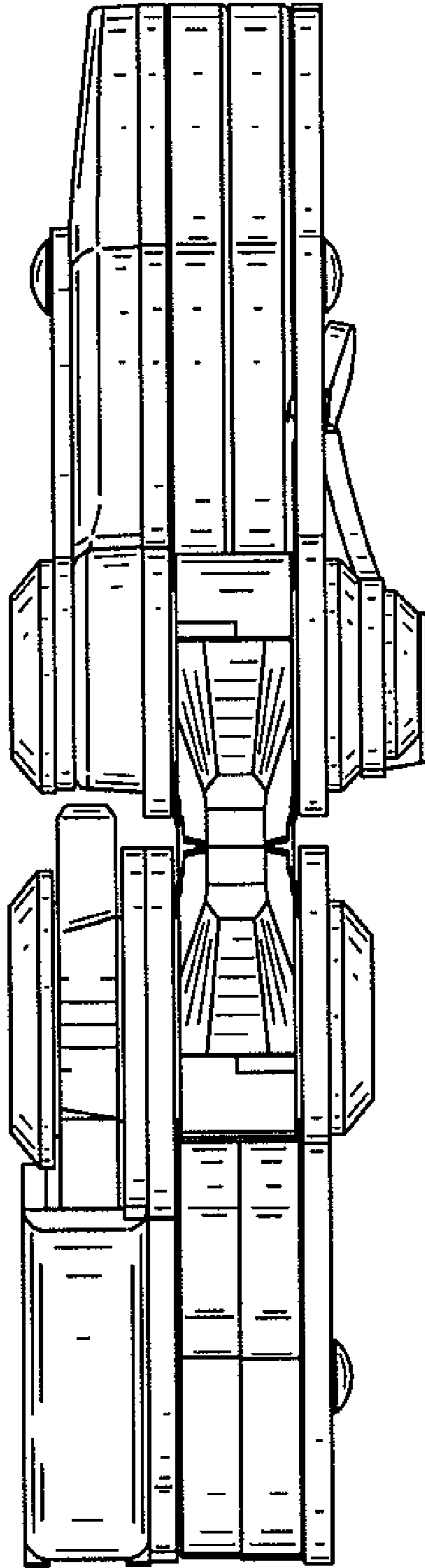

FIG. 7

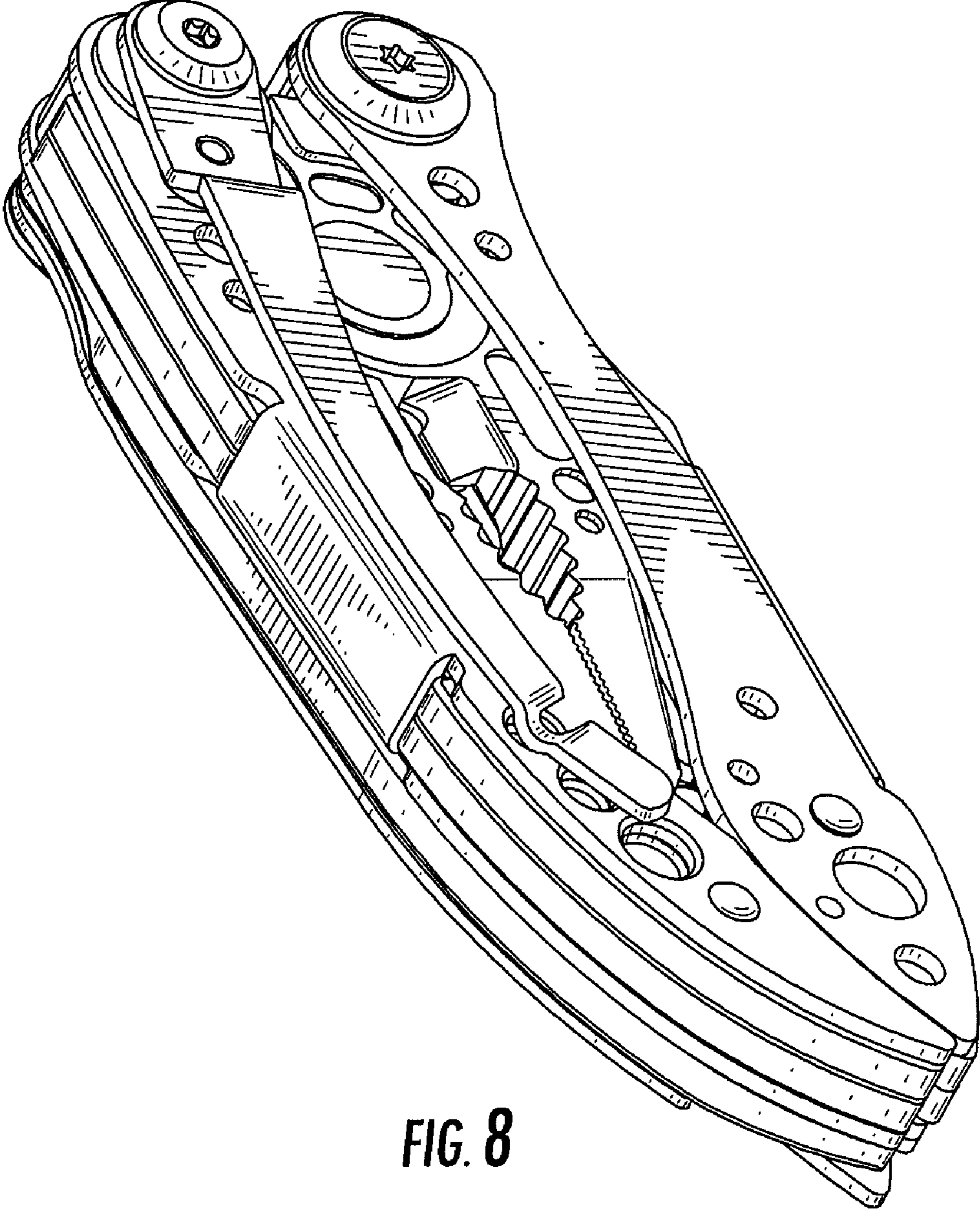

FIG. 8

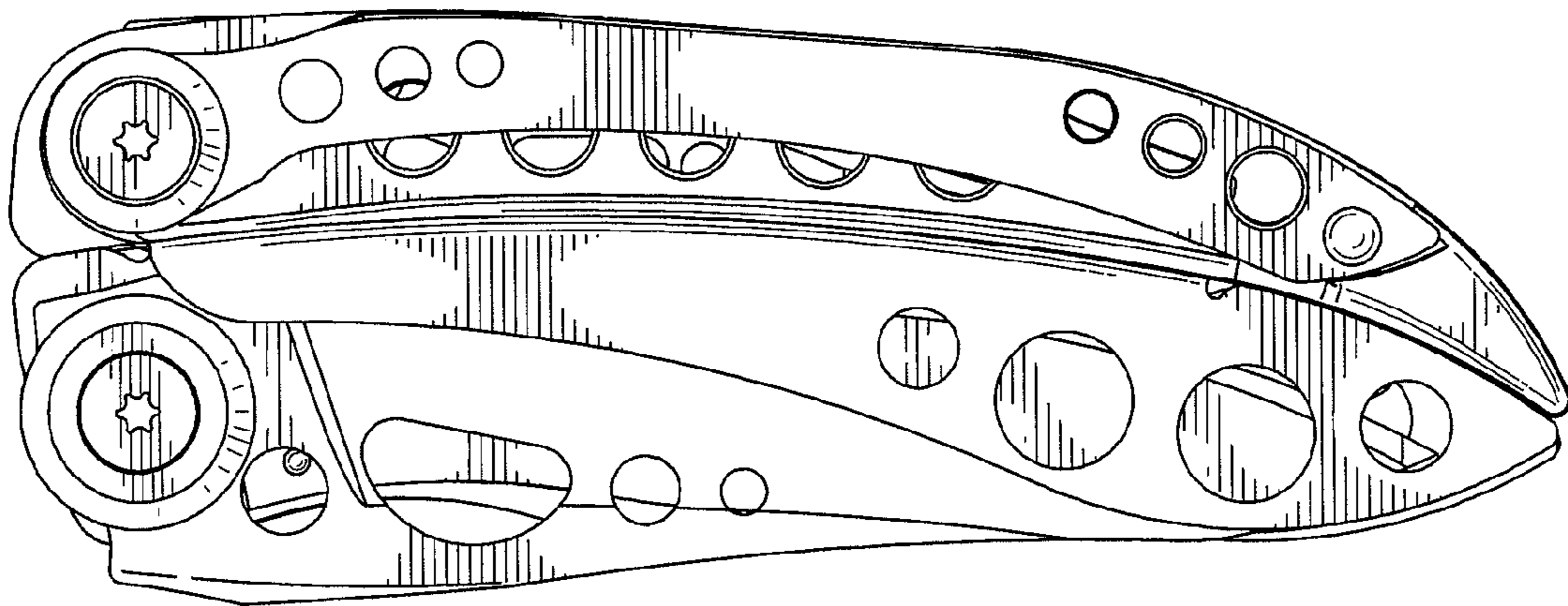
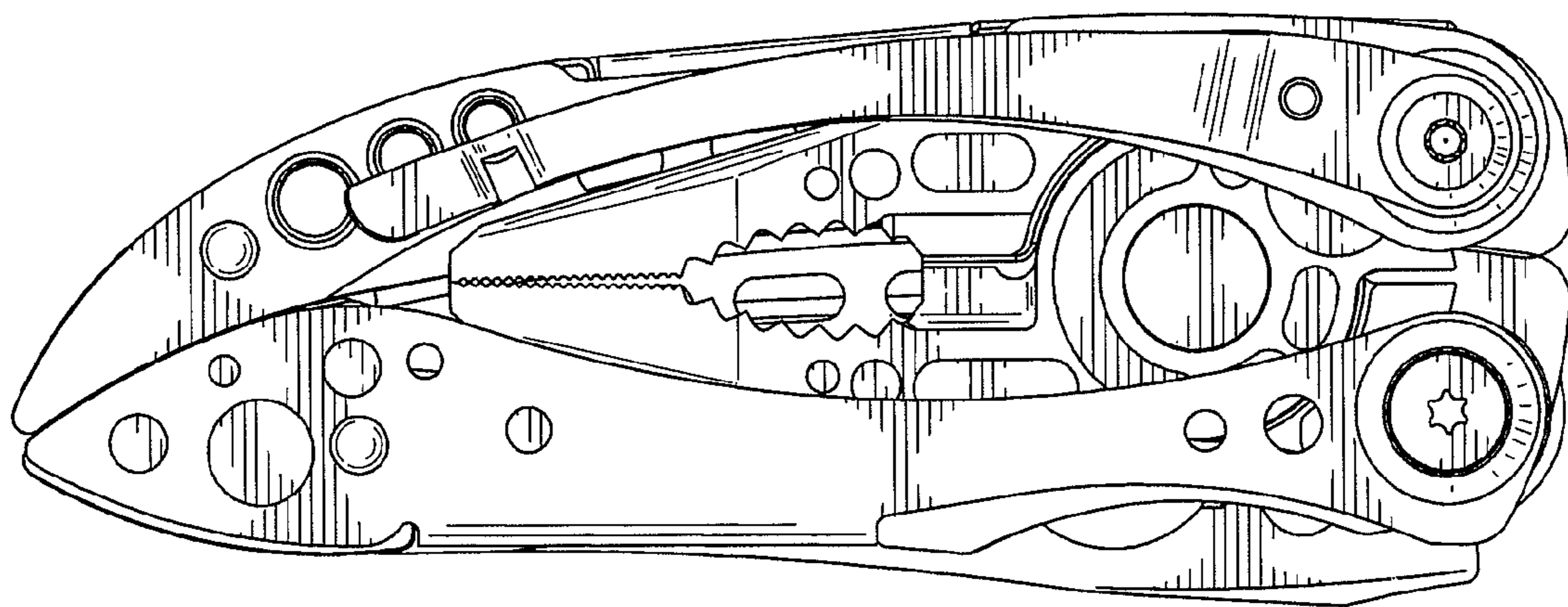
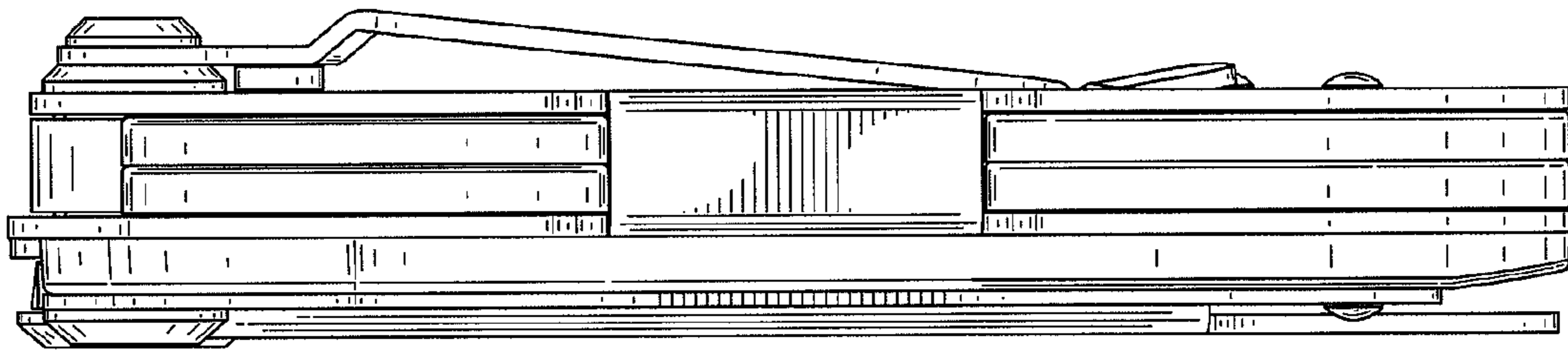

FIG. 9



**FIG. 10**





*FIG. 11*

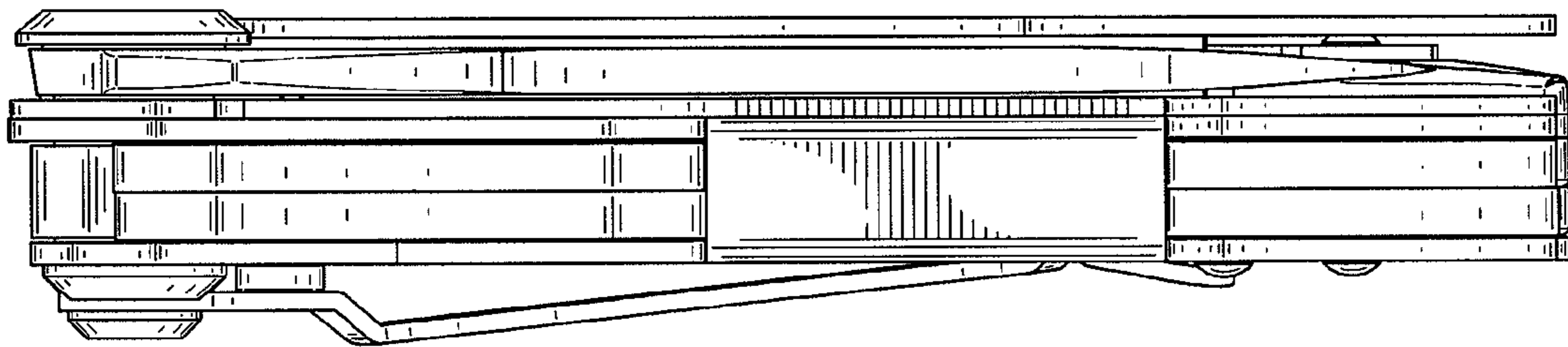
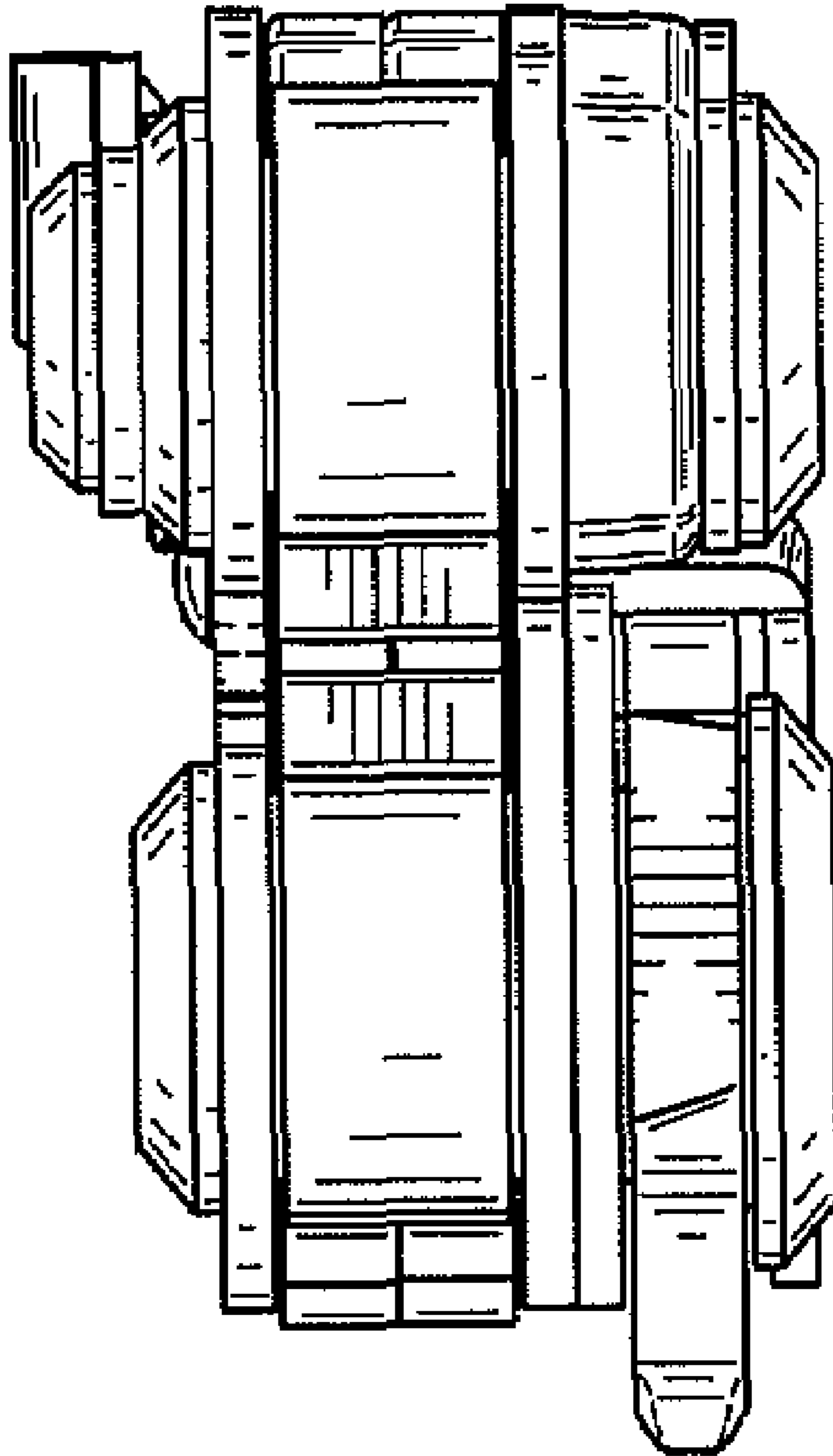
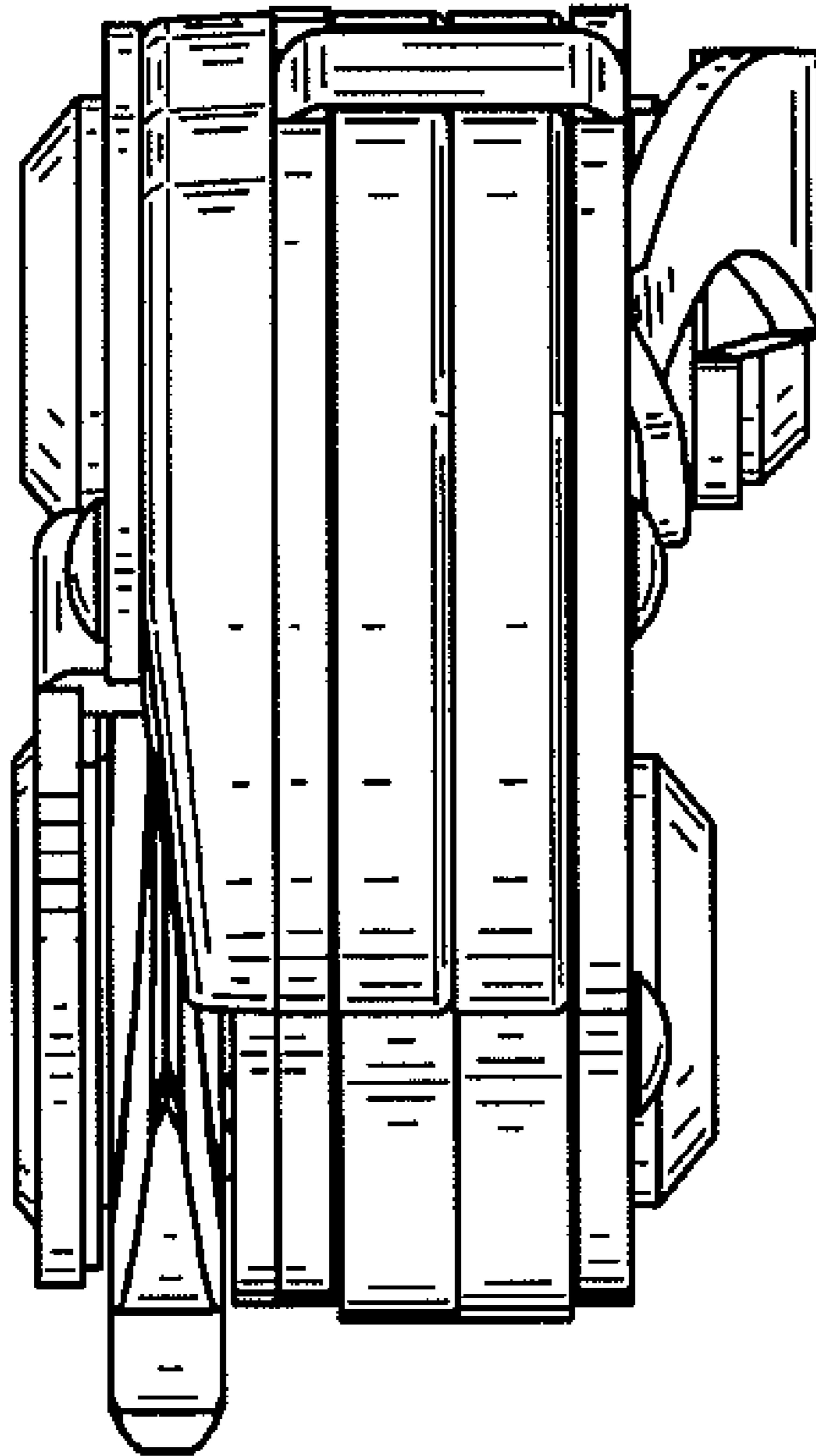

FIG. 12



**FIG. 13**



**FIG. 14**