



US00D596883S

(12) **United States Design Patent**
Tran

(10) **Patent No.:** **US D596,883 S**

(45) **Date of Patent:** **** Jul. 28, 2009**

(54) **BASE FOR SPA CHAIR**

(75) Inventor: **Minh Sang Tran**, Cambridge (CA)

(73) Assignee: **Gulfstream Plastics Ltd.**, Cambridge,
Ontario (CA)

(**) Term: **14 Years**

(21) Appl. No.: **29/328,655**

(22) Filed: **Nov. 26, 2008**

(30) **Foreign Application Priority Data**

May 30, 2008 (CA) 126250

(51) **LOC (9) Cl.** **06-01**

(52) **U.S. Cl.** **D6/495**

(58) **Field of Classification Search** D6/330,
D6/335-338, 340, 349-355, 358, 359, 364,
D6/366, 376, 491, 495, 500-502; 297/16.1,
297/39, 46, 135, 140, 156, 158.3, 158.4,
297/175, 177, 187, 195.1, 195.11, 211, 245,
297/423.1, 423.16, 445.1, 461, 462

See application file for complete search history.

(56) **References Cited**

U.S. PATENT DOCUMENTS

D455,017 S * 4/2002 Tran D6/336
D457,018 S * 5/2002 Park D6/495
6,503,212 B2 * 1/2003 Park 601/158
D498,599 S * 11/2004 Luong D6/336
D526,505 S * 8/2006 Gruenwald et al. D6/381

D541,060 S * 4/2007 Fugate et al. D6/335
D569,135 S * 5/2008 Galati et al. D6/495
D583,171 S * 12/2008 Tran D6/500
D583,576 S * 12/2008 Tran D6/336
D585,142 S * 1/2009 Galati et al. D24/213
D588,844 S * 3/2009 Tran D6/495

* cited by examiner

Primary Examiner—Sandra Snapp

(74) *Attorney, Agent, or Firm*—Alleman Hall McCoy Russell
& Tuttle LLP

(57) **CLAIM**

The ornamental design for a base for spa chair, as shown and
described.

DESCRIPTION

FIG. 1 is a perspective view of the base according to the
present invention.

FIG. 2 is an alternate perspective view of the base of FIG. 1.

FIG. 3 is a top view of the base of FIG. 1.

FIG. 4 is a left side view of the base of FIG. 1.

FIG. 5 is a bottom view of the base of FIG. 1.

FIG. 6 is a right side view of the base of FIG. 1.

FIG. 7 is a front view of the base of FIG. 1; and,

FIG. 8 is a rear view of the base of FIG. 1.

The dashed lines illustrate a pedestal for the base, and form no
part of the claimed design.

1 Claim, 4 Drawing Sheets

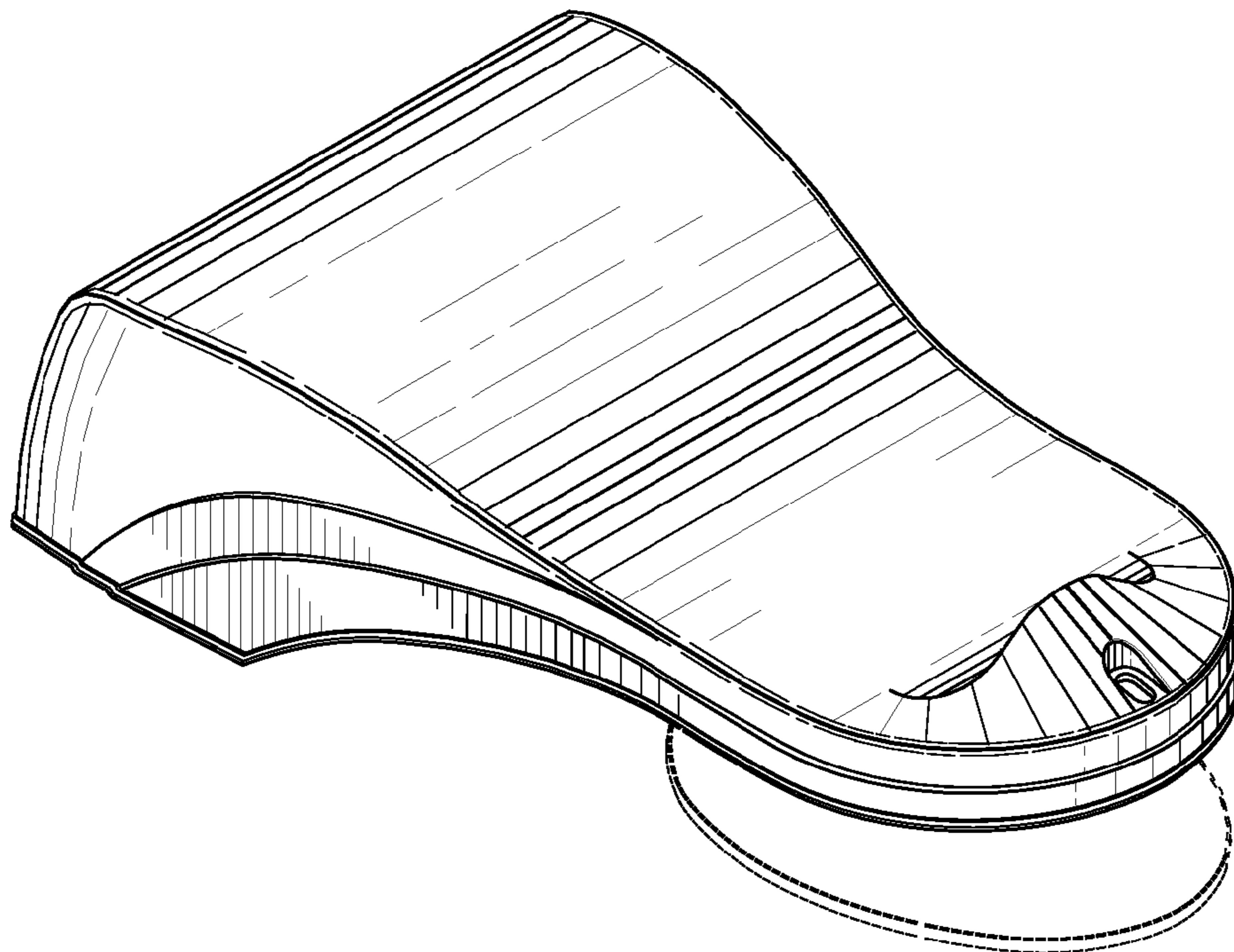

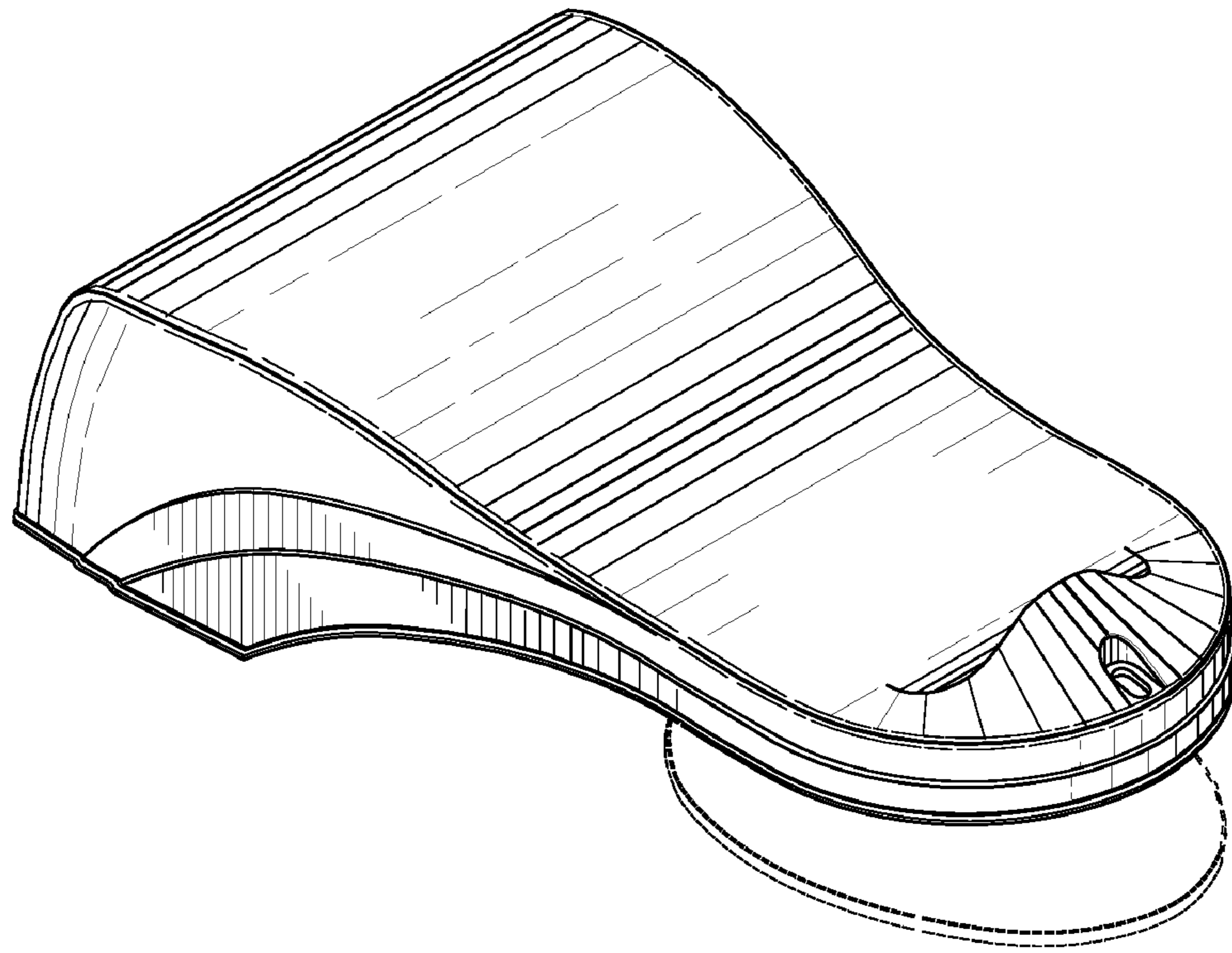

FIG.1

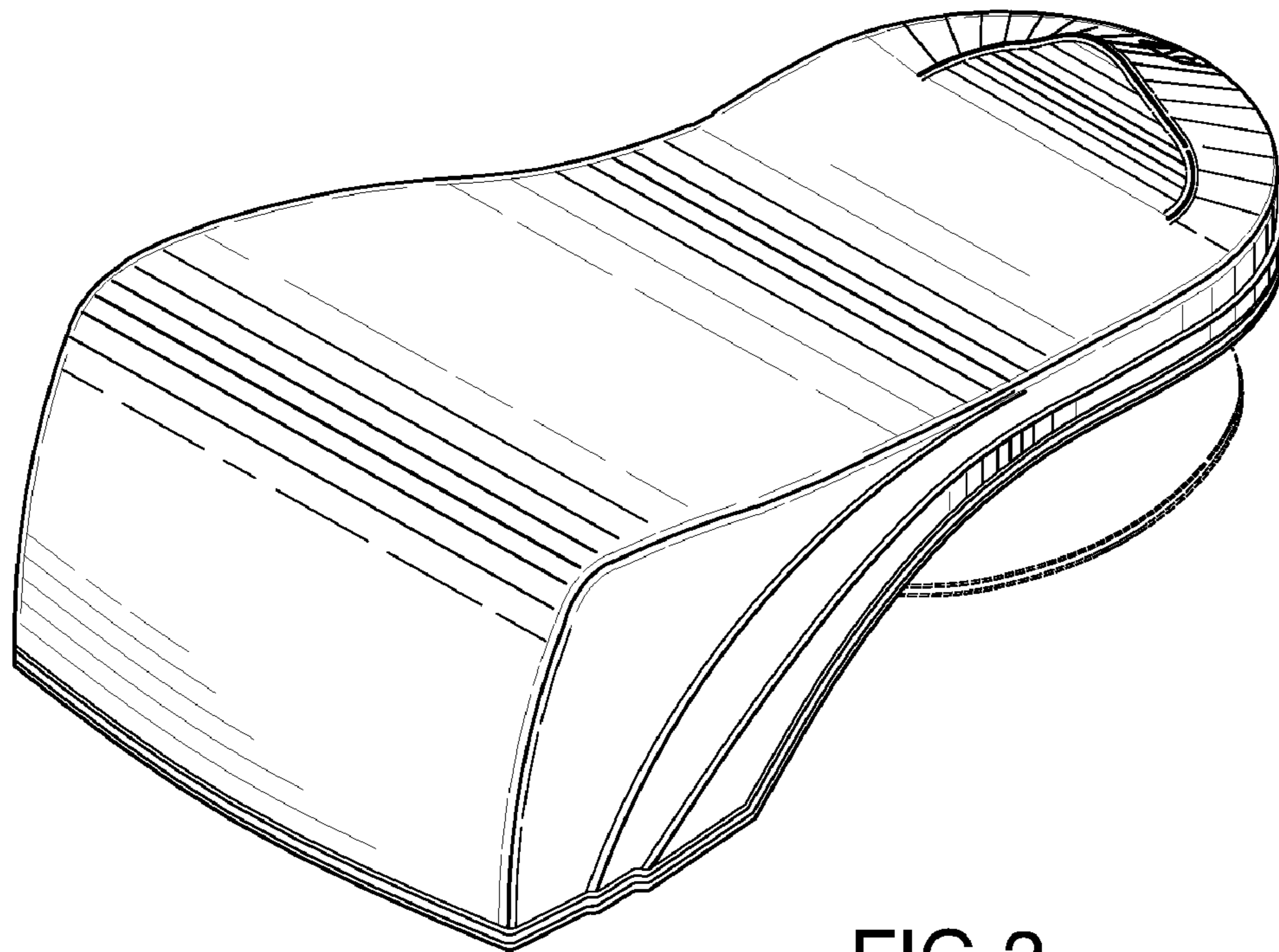

FIG.2

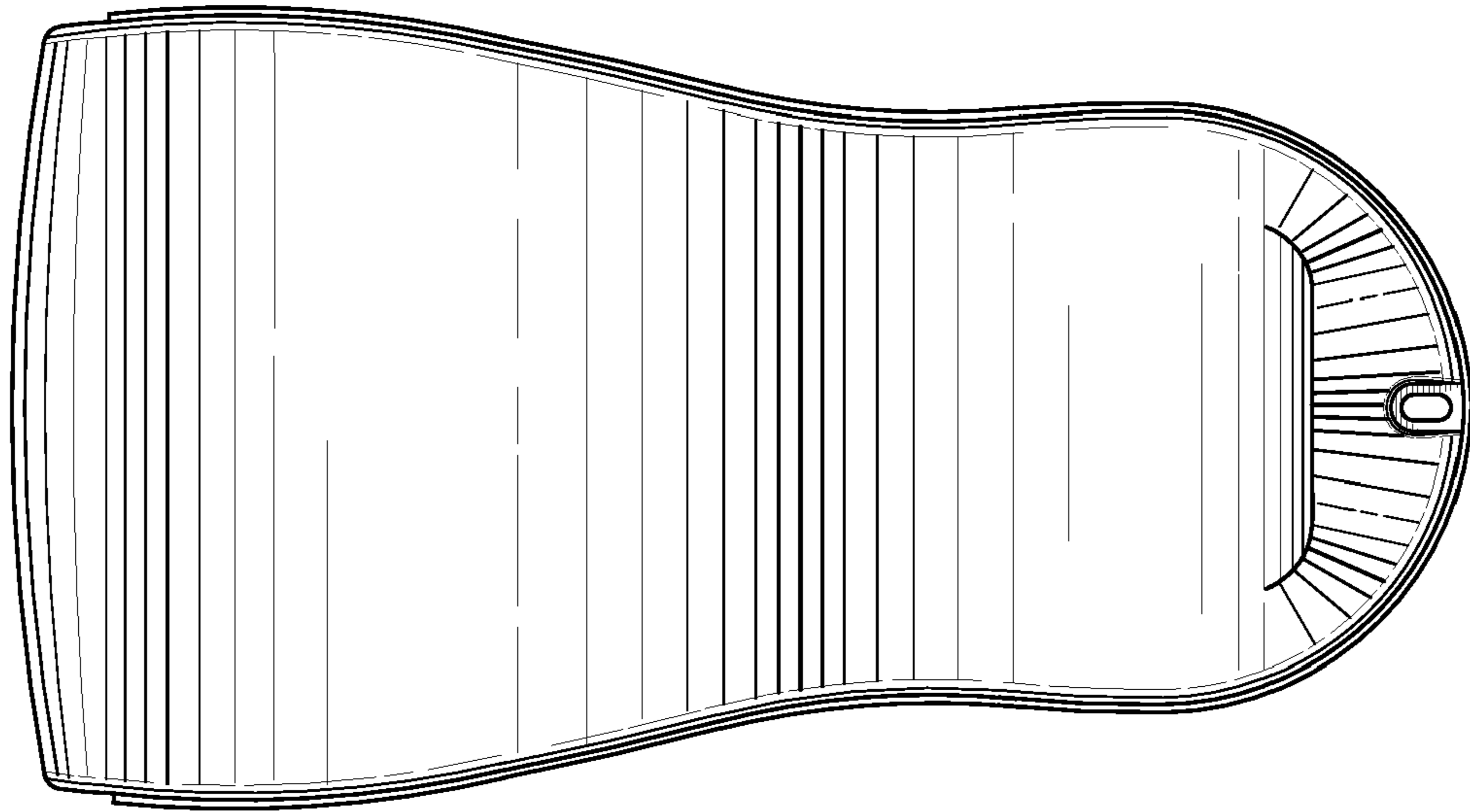

FIG.3

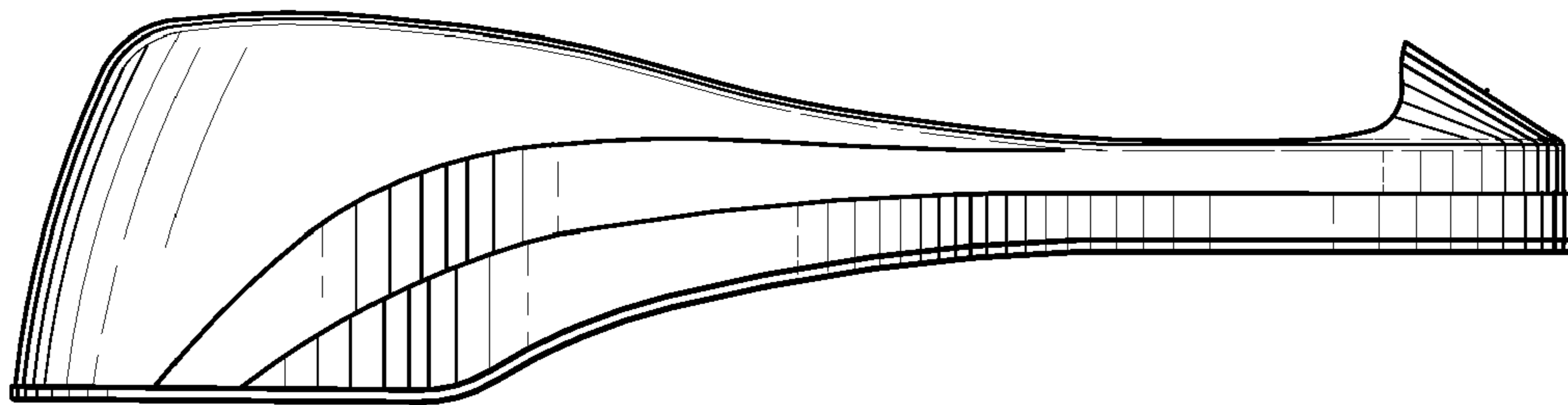

FIG.4

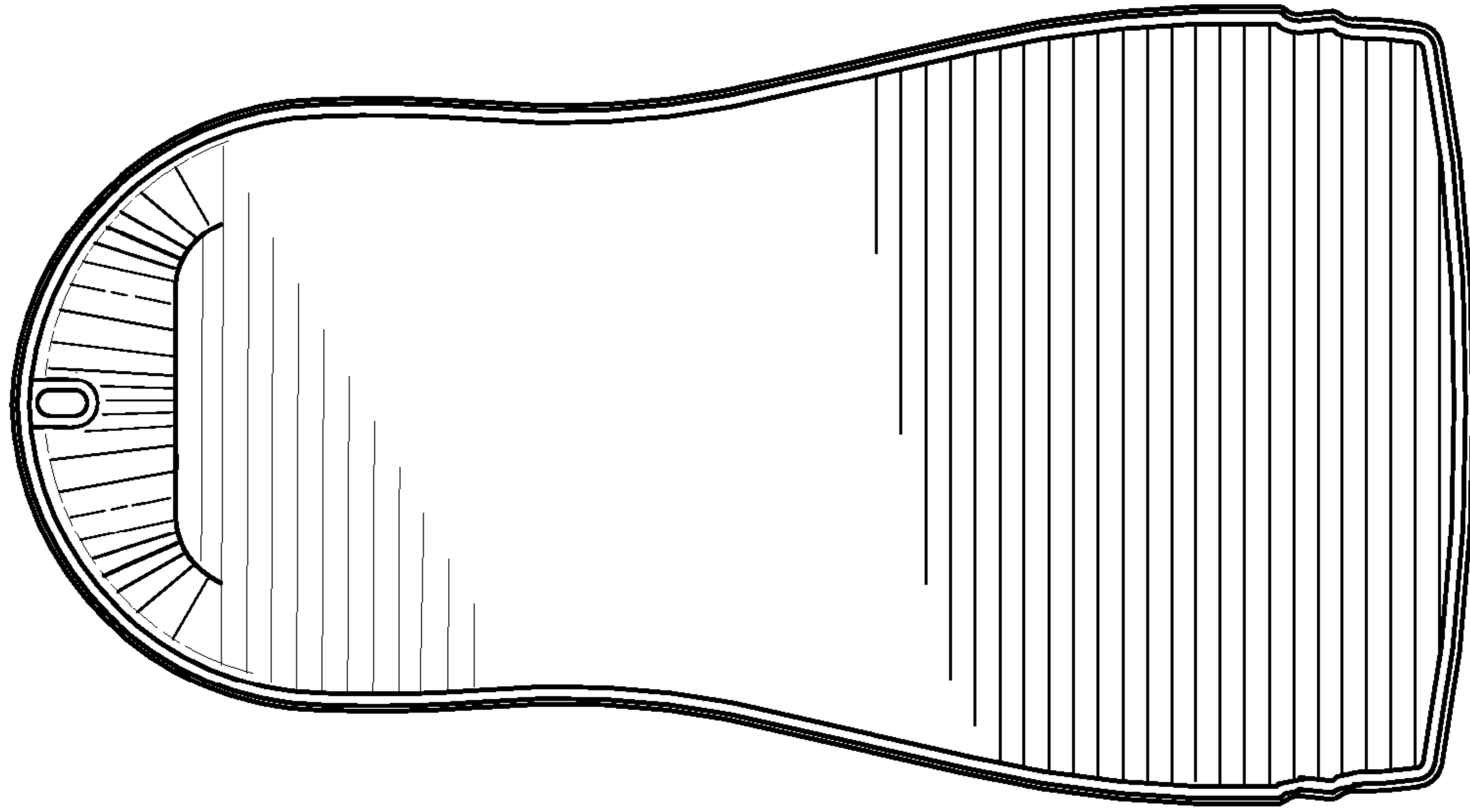

FIG. 5

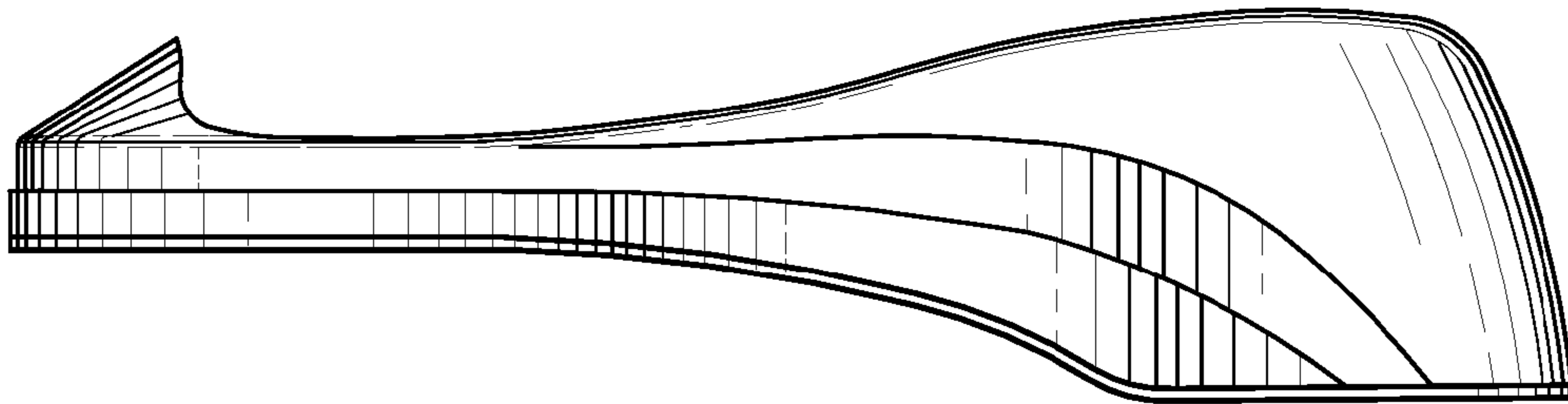

FIG. 6

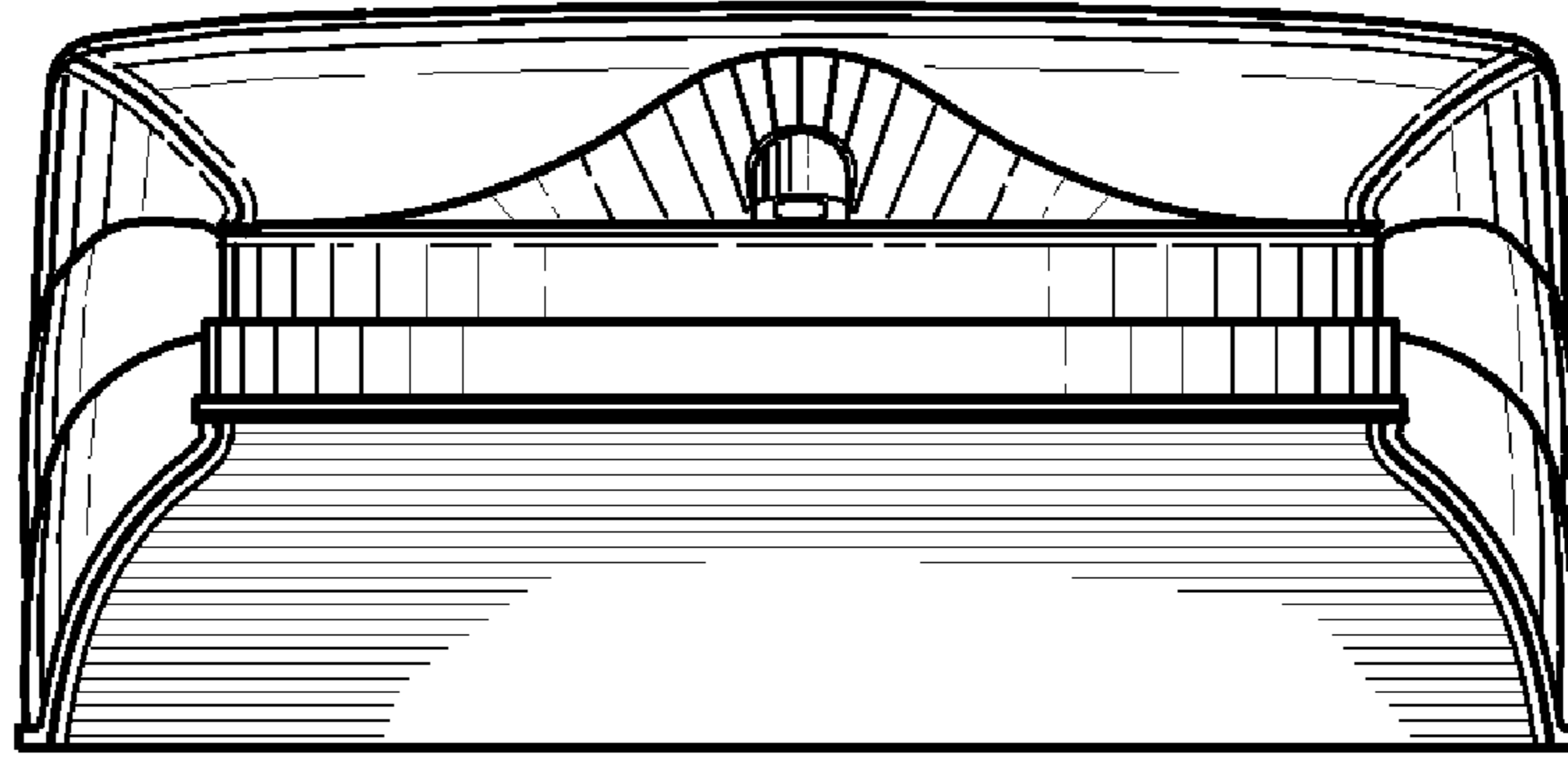

FIG. 7

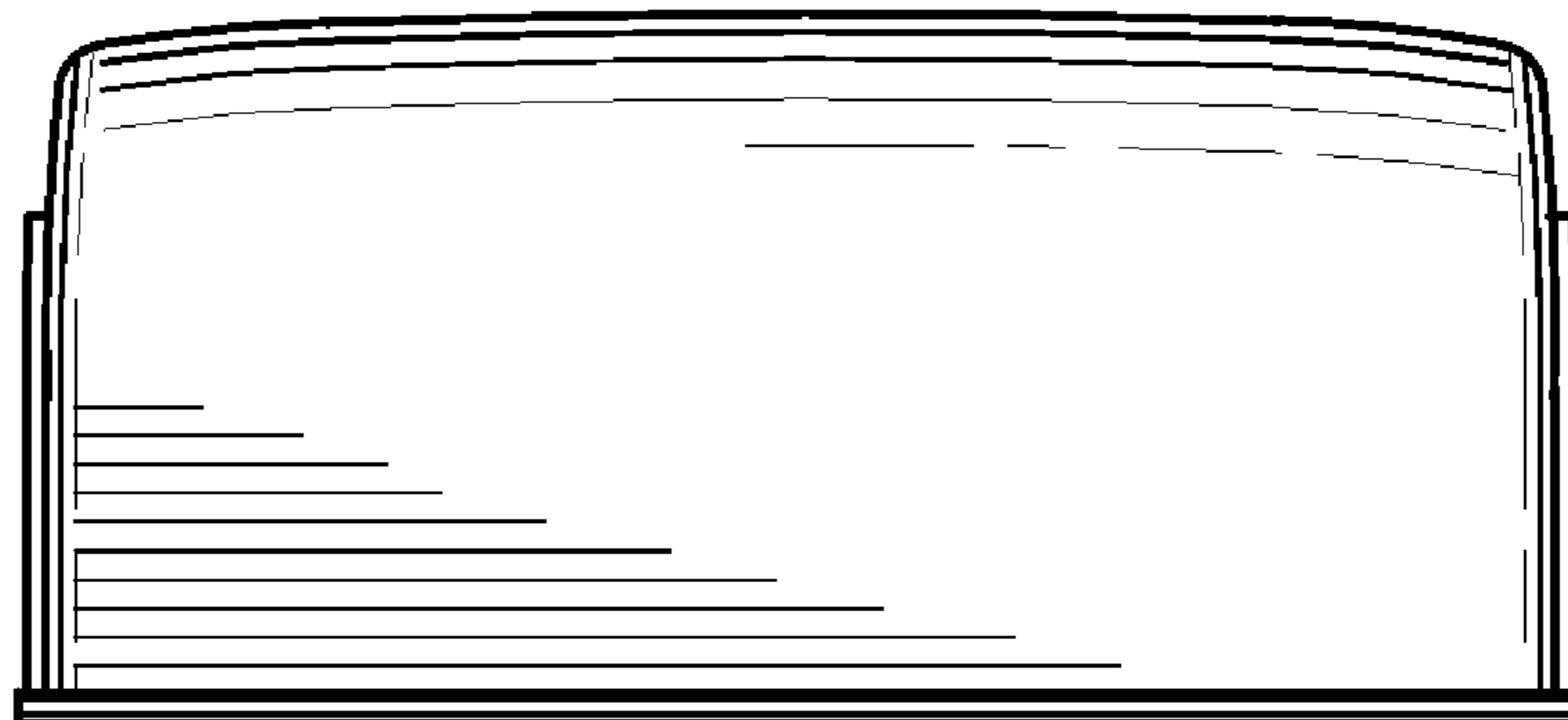

FIG. 8