

US00D596858S

(12) **United States Design Patent**
Chu et al.

(10) **Patent No.:** **US D596,858 S**
(45) **Date of Patent:** **** Jul. 28, 2009**

(54) **BRIEFCASE**

(75) Inventors: **David Ching Chi Chu**, New York, NY (US); **Victor Sanz**, Whitehouse Station, NJ (US); **Paul Victor Scicluna**, Penndel, PA (US)

(73) Assignee: **Tumi, Inc.**, South Plainfield, NJ (US)

(**) Term: **14 Years**

(21) Appl. No.: **29/317,929**

(22) Filed: **May 9, 2008**

(51) **LOC (9) Cl.** **03-01**

(52) **U.S. Cl.** **D3/321**

(58) **Field of Classification Search** D3/324,
D3/327, 321, 318, 326; 150/100, 107, 118
See application file for complete search history.

(56) **References Cited**

U.S. PATENT DOCUMENTS

D368,370 S *	4/1996	Tawil	D3/276
D507,107 S *	7/2005	Goldberg	D3/246
D517,321 S *	3/2006	Wilde et al.	D3/321
D527,904 S *	9/2006	Rafanelli	D3/318
D545,056 S *	6/2007	Leighton	D3/217

* cited by examiner

Primary Examiner—Holly H Baynham
Assistant Examiner—Sheryl Lane

(74) *Attorney, Agent, or Firm*—Baker Botts L.L.P.

(57) **CLAIM**

The ornamental design for a briefcase, as shown and described.

DESCRIPTION

FIG. 1 is a perspective view of a first embodiment of the briefcase.

FIG. 2 is a front view of the embodiment of FIG. 1.

FIG. 3 is a rear view of the embodiment of FIG. 1.

FIG. 4 is a right side view of the embodiment of FIG. 1.

FIG. 5 is a left side view of the embodiment of FIG. 1.

FIG. 6 is a top view of the embodiment of FIG. 1.

FIG. 7 is a bottom view of the embodiment of FIG. 1.

FIG. 8 is a perspective view of a second embodiment of the briefcase.

FIG. 9 is a front view of the embodiment of FIG. 8.

FIG. 10 is a rear view of the embodiment of FIG. 8.

FIG. 11 is a right side view of the embodiment of FIG. 8.

FIG. 12 is a left side view of the embodiment of FIG. 8.

FIG. 13 is a top view of the embodiment of FIG. 8; and,

FIG. 14 is a bottom view of the embodiment of FIG. 8.

1 Claim, 10 Drawing Sheets

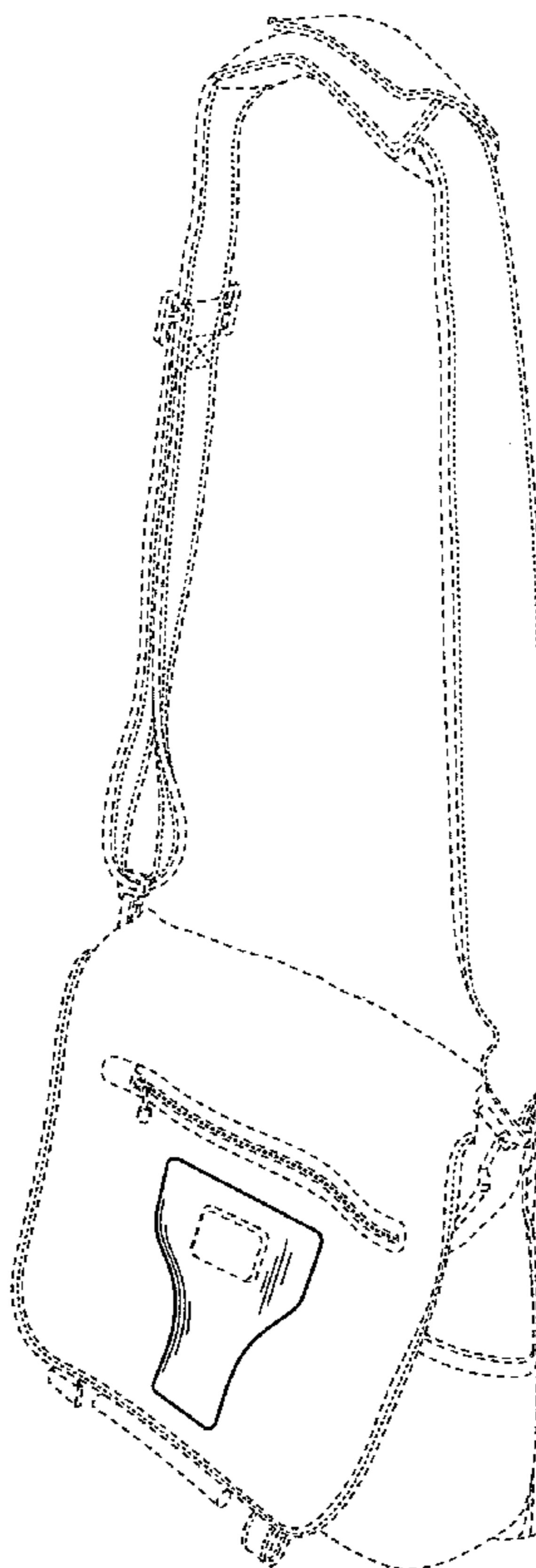

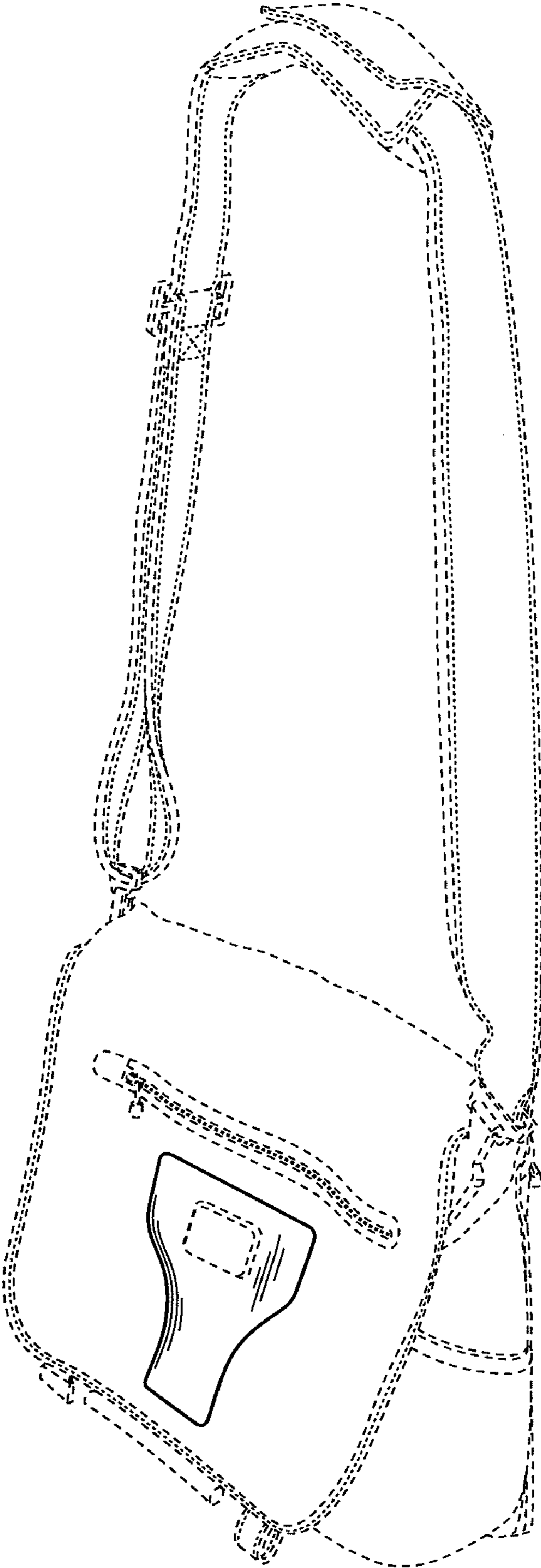

FIG. 1

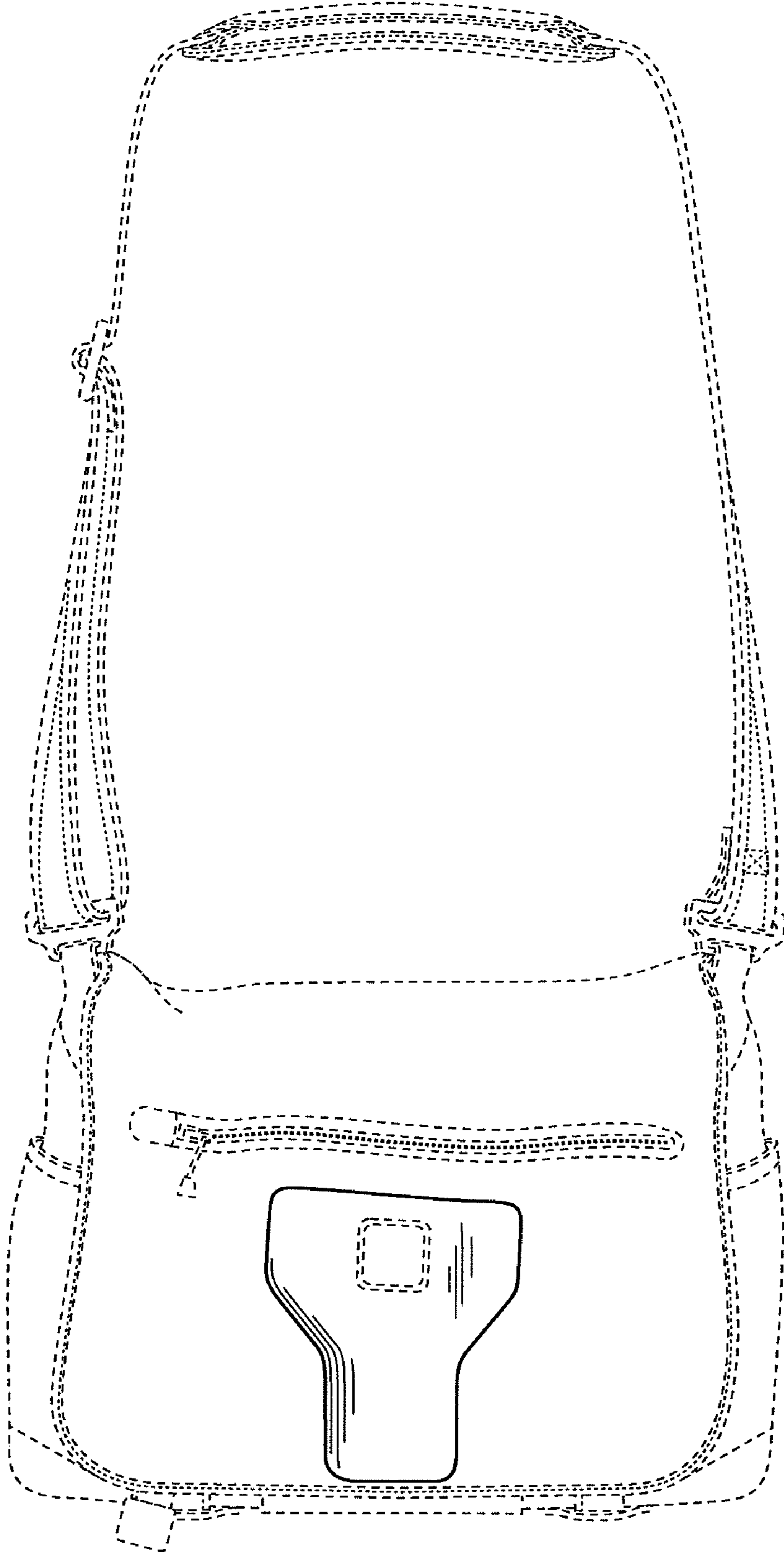

FIG. 2

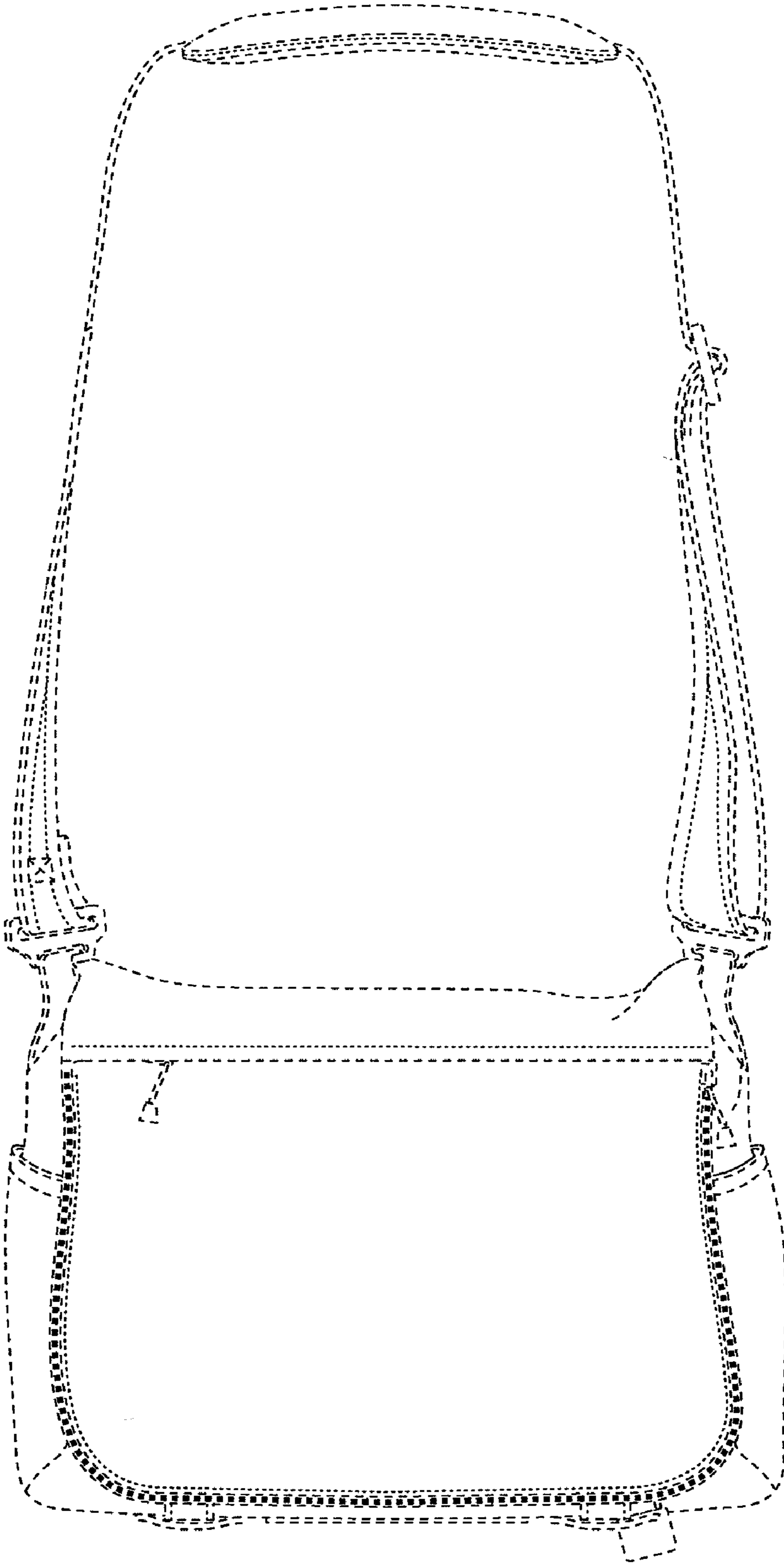

FIG. 3

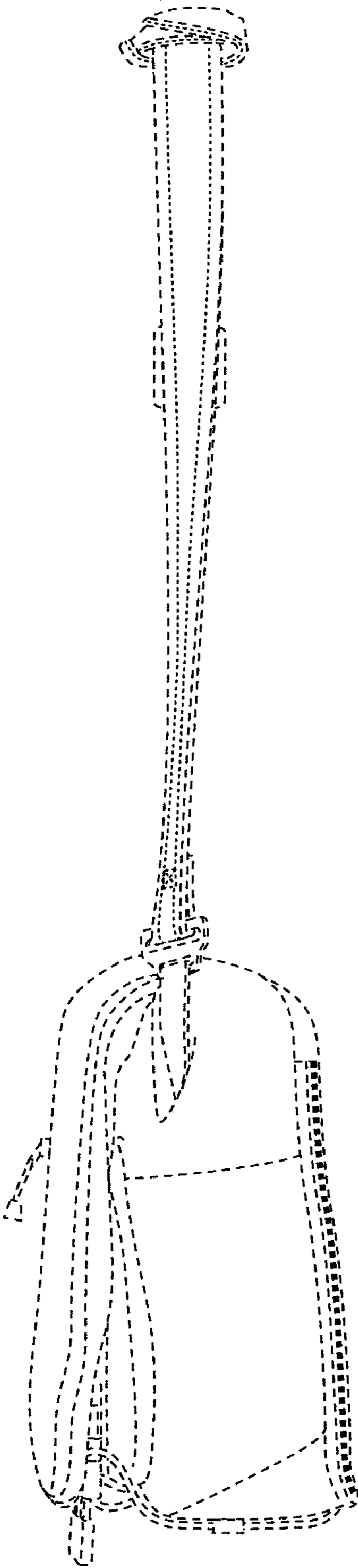

FIG. 4

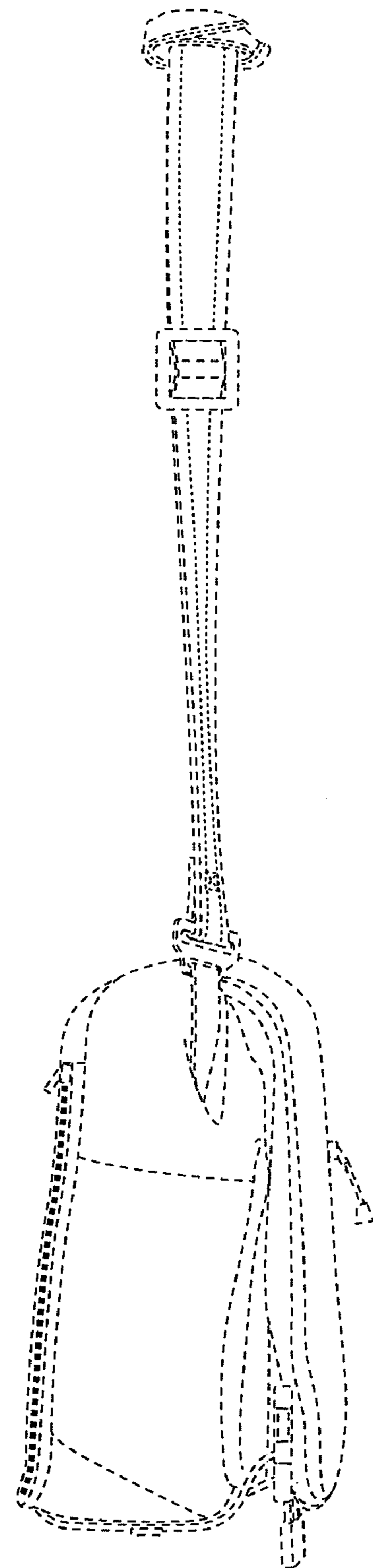

FIG. 5

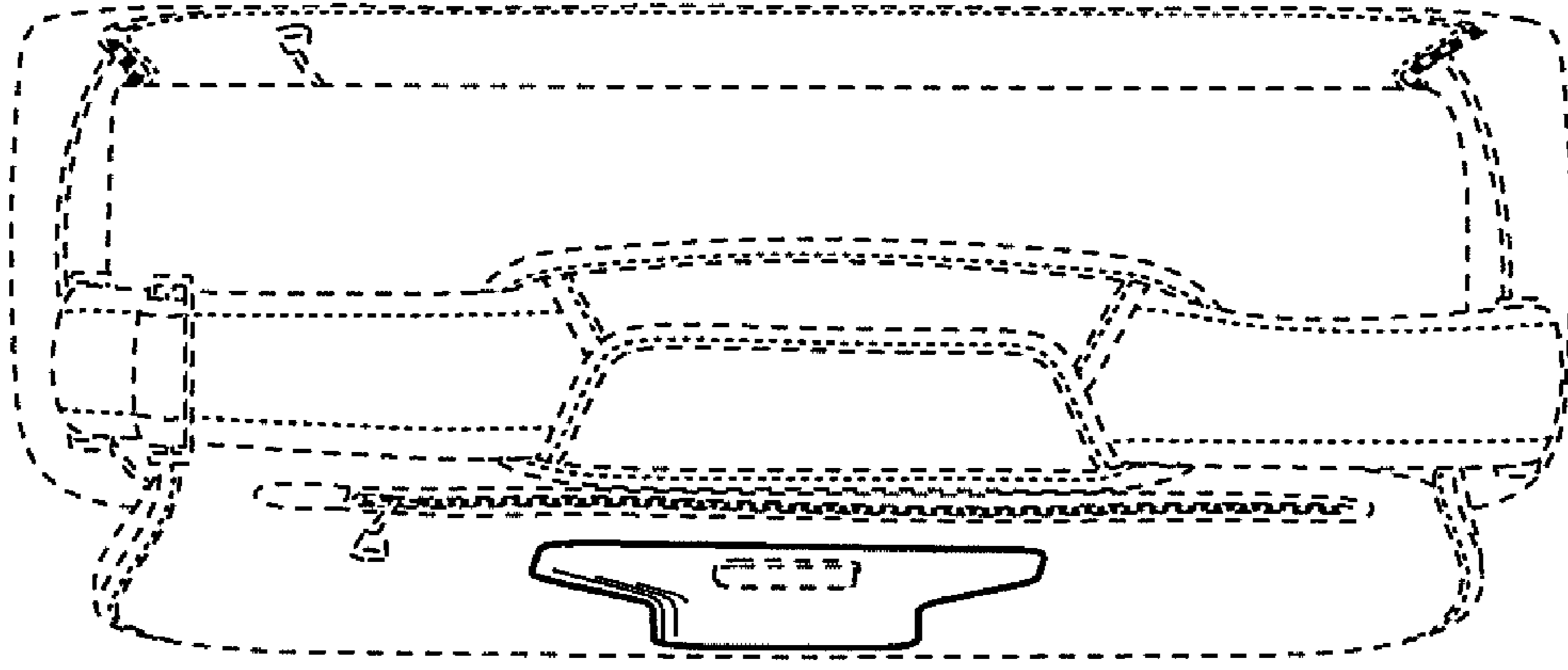

FIG. 6

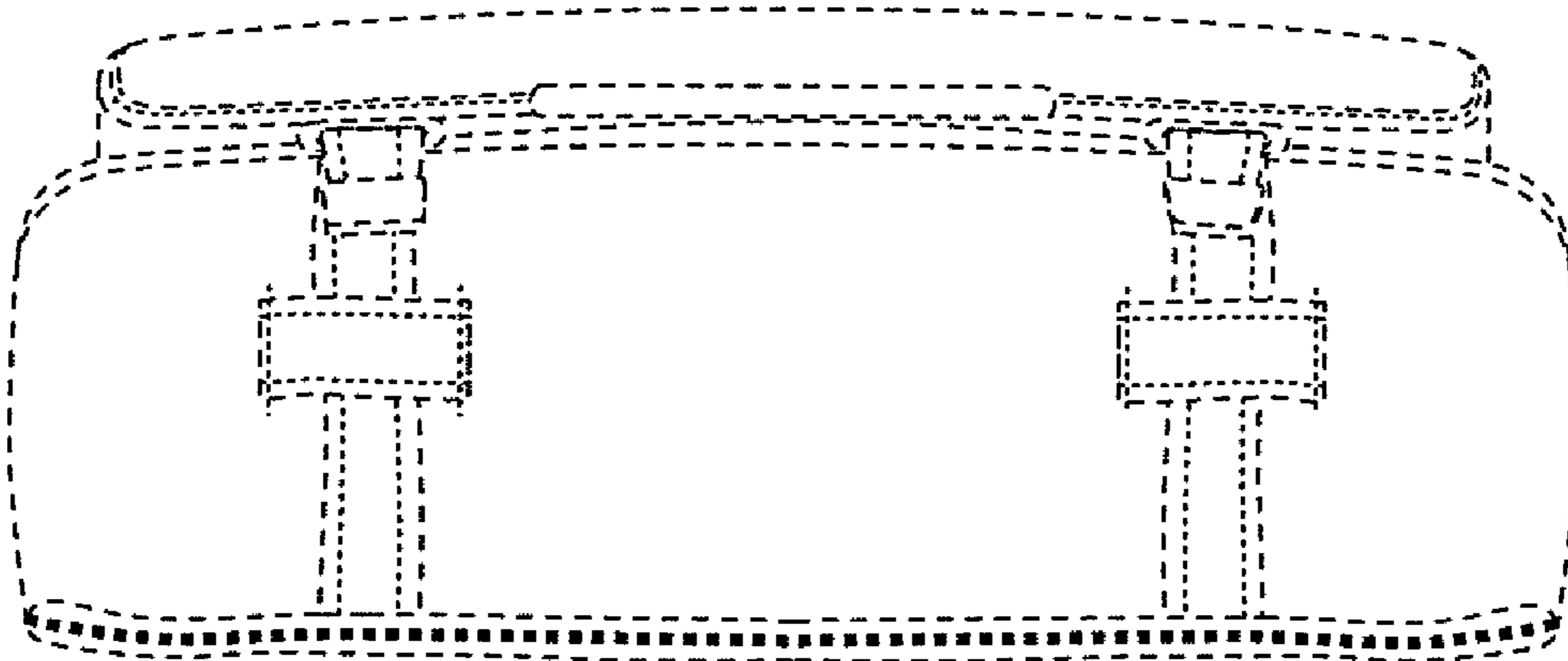

FIG. 7

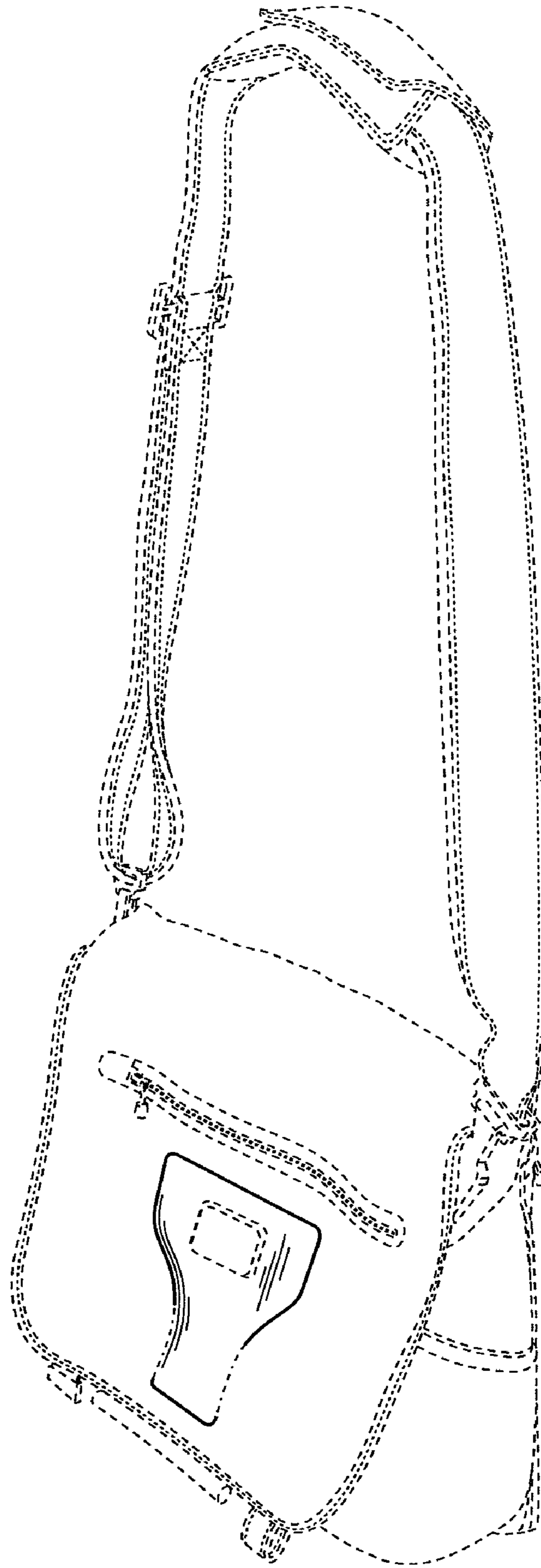

FIG. 8

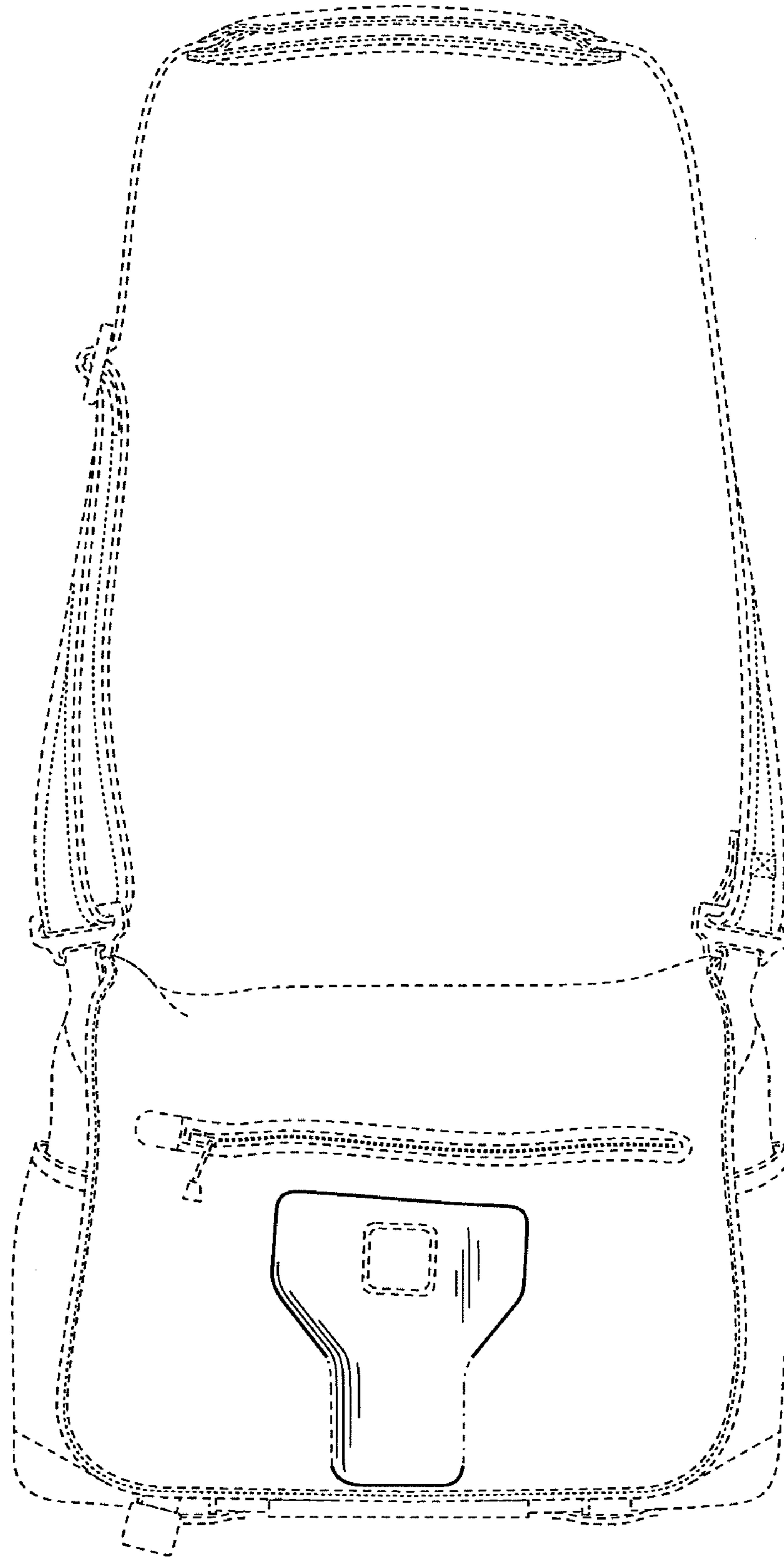

FIG. 9

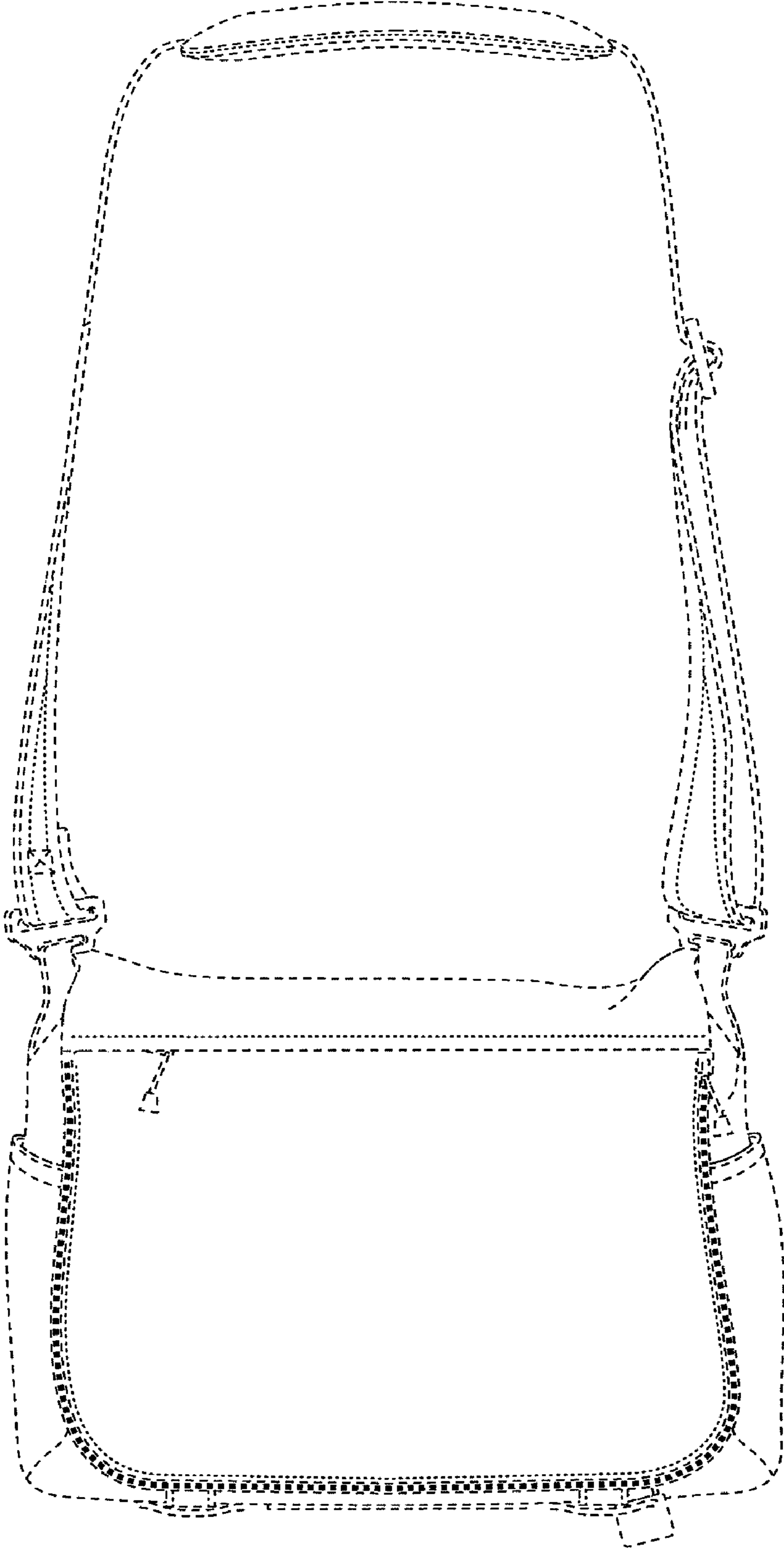

FIG. 10

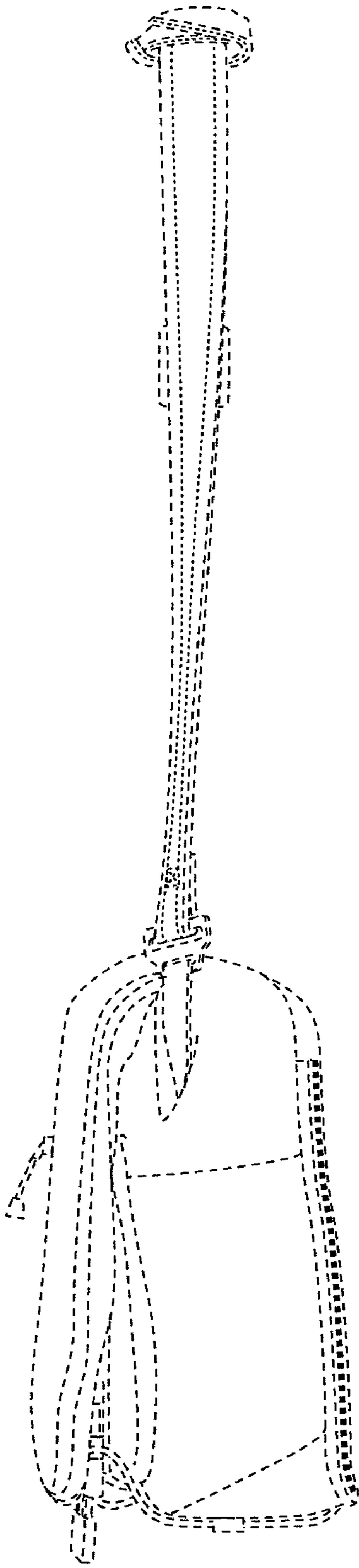

FIG. 11

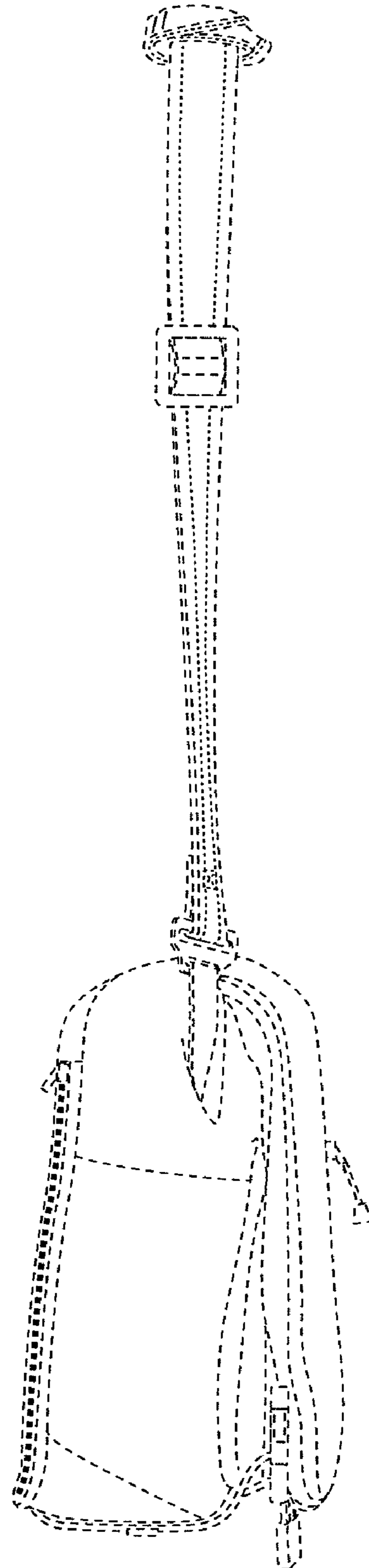

FIG. 12

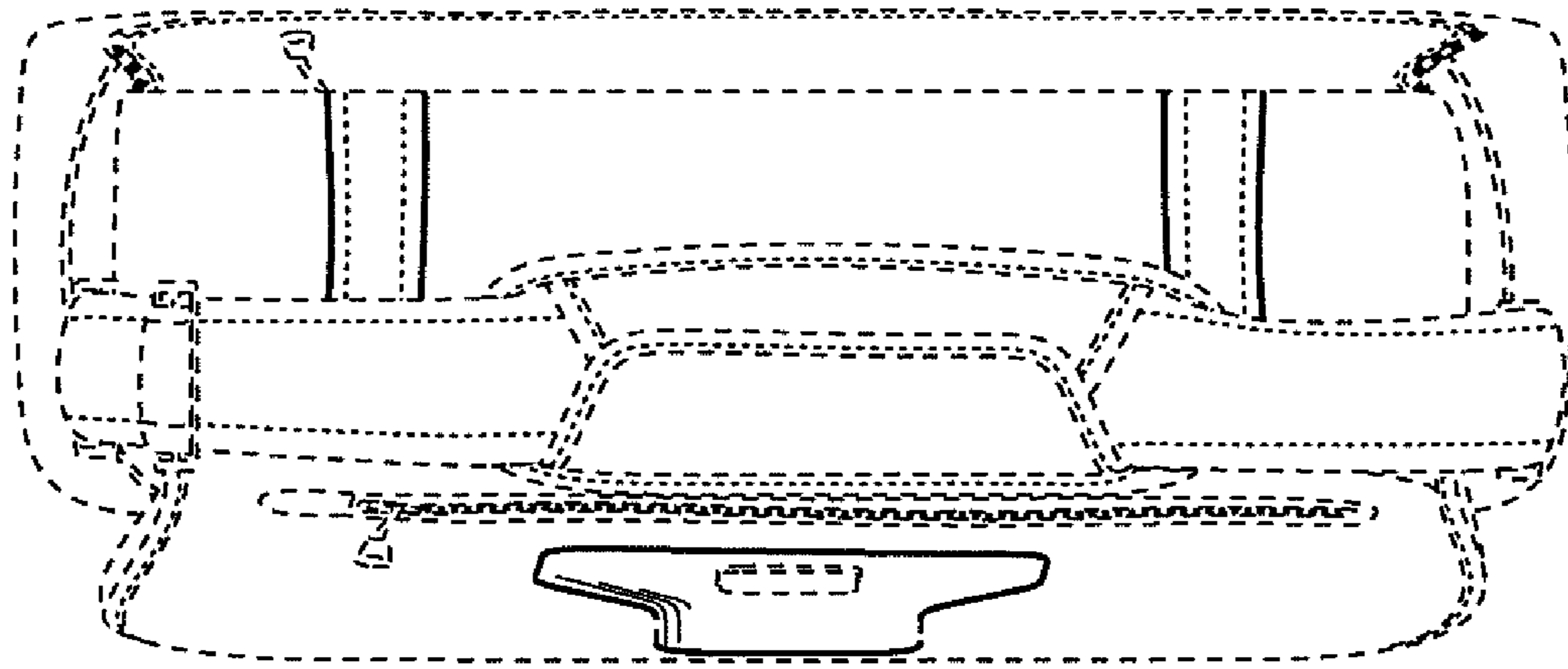

FIG. 13

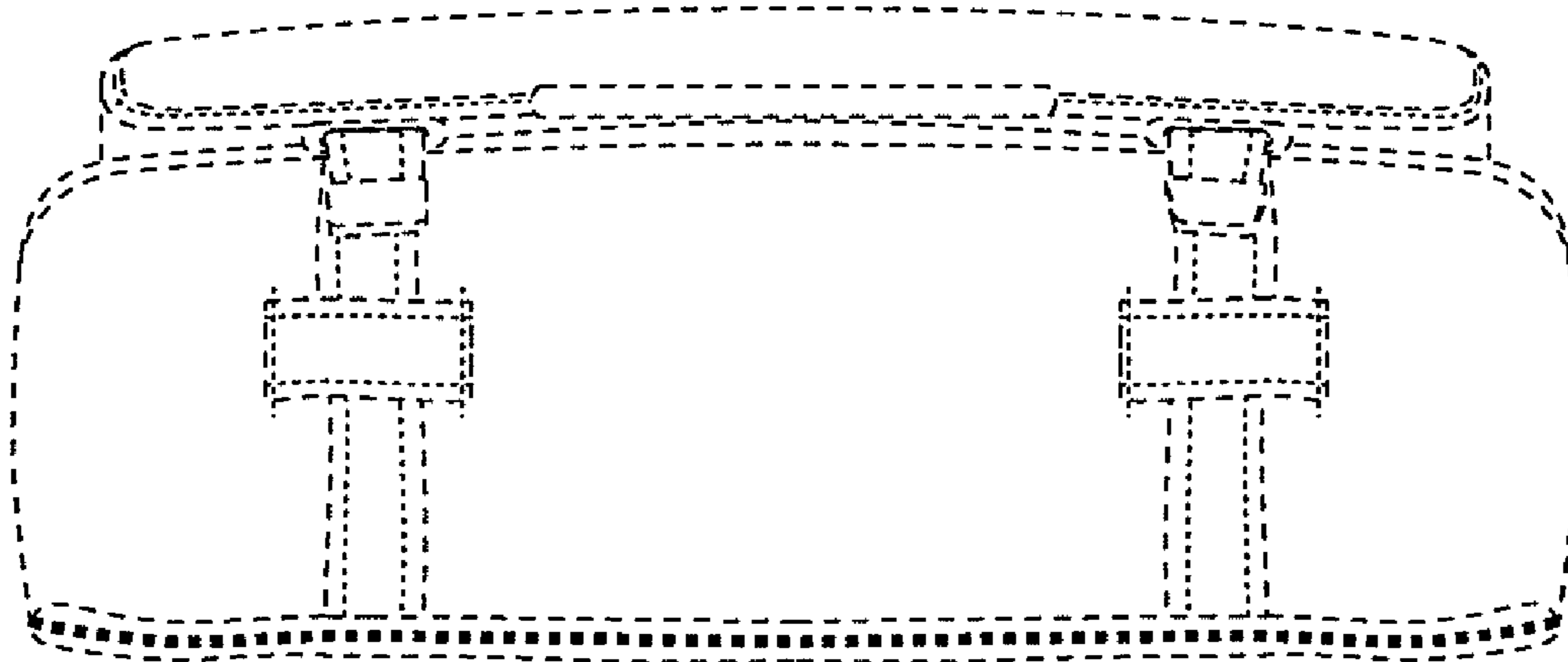

FIG. 14