



US00D596776S

(12) **United States Design Patent**
Hodgson

(10) **Patent No.:** **US D596,776 S**
(45) **Date of Patent:** **** Jul. 21, 2009**

(54) **LAMP**

(75) Inventor: **Fraser Milbourne Hodgson**, London (GB)

(73) Assignee: **The Daylight Company (Holdings) Limited** (GB)

(**) Term: **14 Years**

(21) Appl. No.: **29/322,565**

(22) Filed: **Aug. 7, 2008**

(30) **Foreign Application Priority Data**

Aug. 2, 2008 (EM) 000878160

(51) **LOC (9) Cl.** **26-05**

(52) **U.S. Cl.** **D26/63**

(58) **Field of Classification Search** D26/28,
D26/37, 39, 60-63, 65; 362/98, 99, 109,
362/116, 191, 197, 198, 155, 156, 396, 473-476
See application file for complete search history.

(56) **References Cited**

U.S. PATENT DOCUMENTS

4,977,489 A * 12/1990 Fung 362/184
D469,201 S * 1/2003 De Bevilacqua D26/65
6,729,739 B2 * 5/2004 Siegel et al. 362/85
D524,976 S * 7/2006 Hodgson D26/60
D543,304 S * 5/2007 Chan D26/60

OTHER PUBLICATIONS

OTT-LITE 13W Axiom Steel Task Light. Found at Amazon.com Feb. 16, 2009.*

OTT-LITE 13W Mini Task Lamp. Found at Amazon.com Feb. 16, 2009.*

Verilux model #VP02AA1—Natural Spectrum Deluxe Portable Lamp. Found at studentmarket.com Feb. 16, 2009.*

Daylight Company—Freedom Battery Lamp. Found at us.daylightcompany.com Feb. 16, 2009.*

* cited by examiner

Primary Examiner—Clare E Heflin

(74) *Attorney, Agent, or Firm*—Lawrence E. Laubscher, Jr.

(57) **CLAIM**

The ornamental design for a lamp, as shown and described.

DESCRIPTION

FIG. 1 is a front, right side perspective view of the lamp illustrating my new design;

FIG. 2 is a left side elevation view of the lamp of FIG. 1;

FIG. 3 is a front, right perspective view showing the lamp of FIG. 2 in the open condition;

FIG. 4 is a front elevation view showing the lamp of FIG. 3 in the open condition;

FIG. 5 is a rear elevation view showing the lamp of FIG. 3 in the open condition;

FIG. 6 is a top plan view showing the lamp of FIGS. 1-3 in the open condition; and,

FIG. 7 is a bottom plan view showing the lamp of FIGS. 1-3 in the open condition.

1 Claim, 4 Drawing Sheets

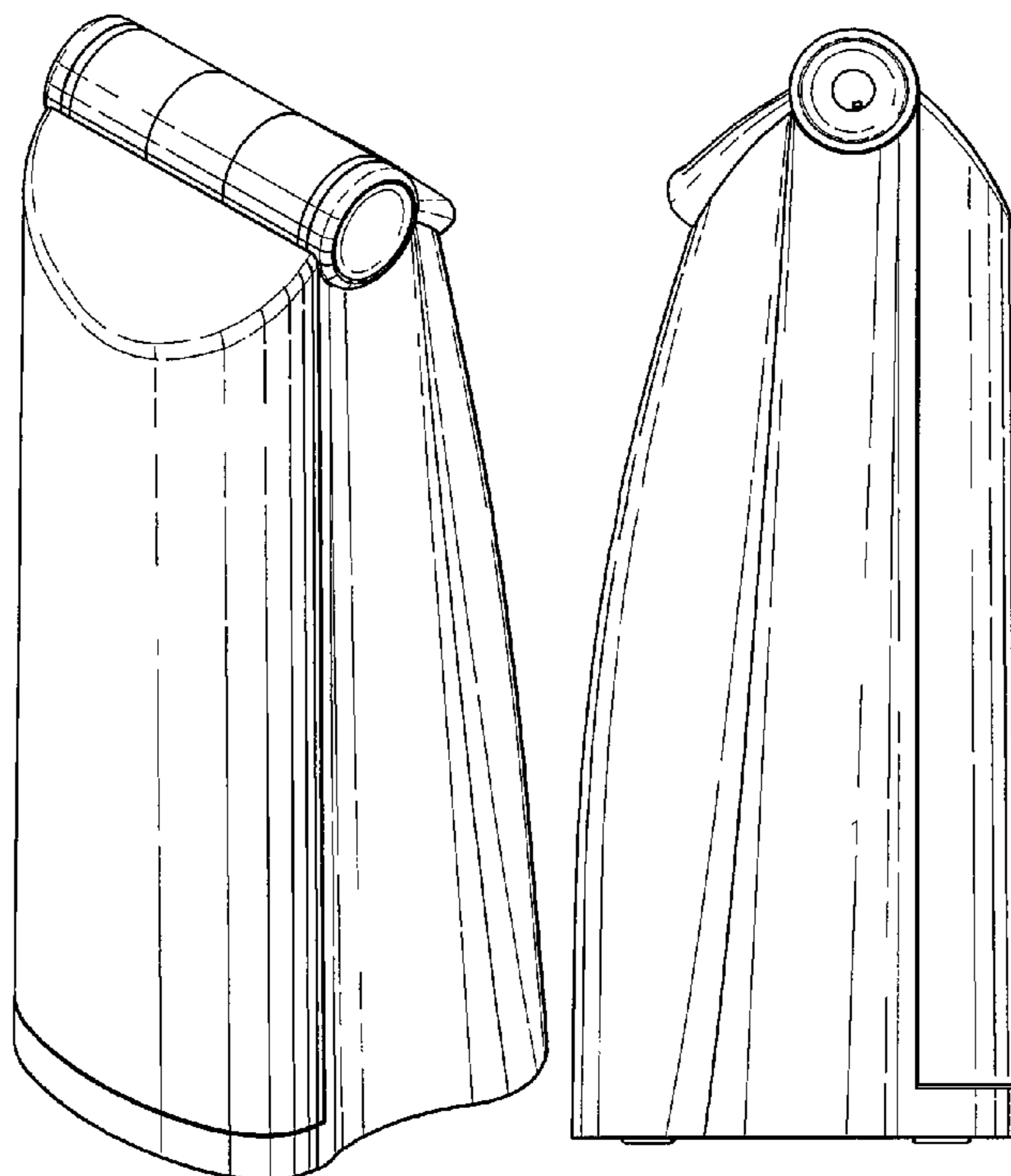

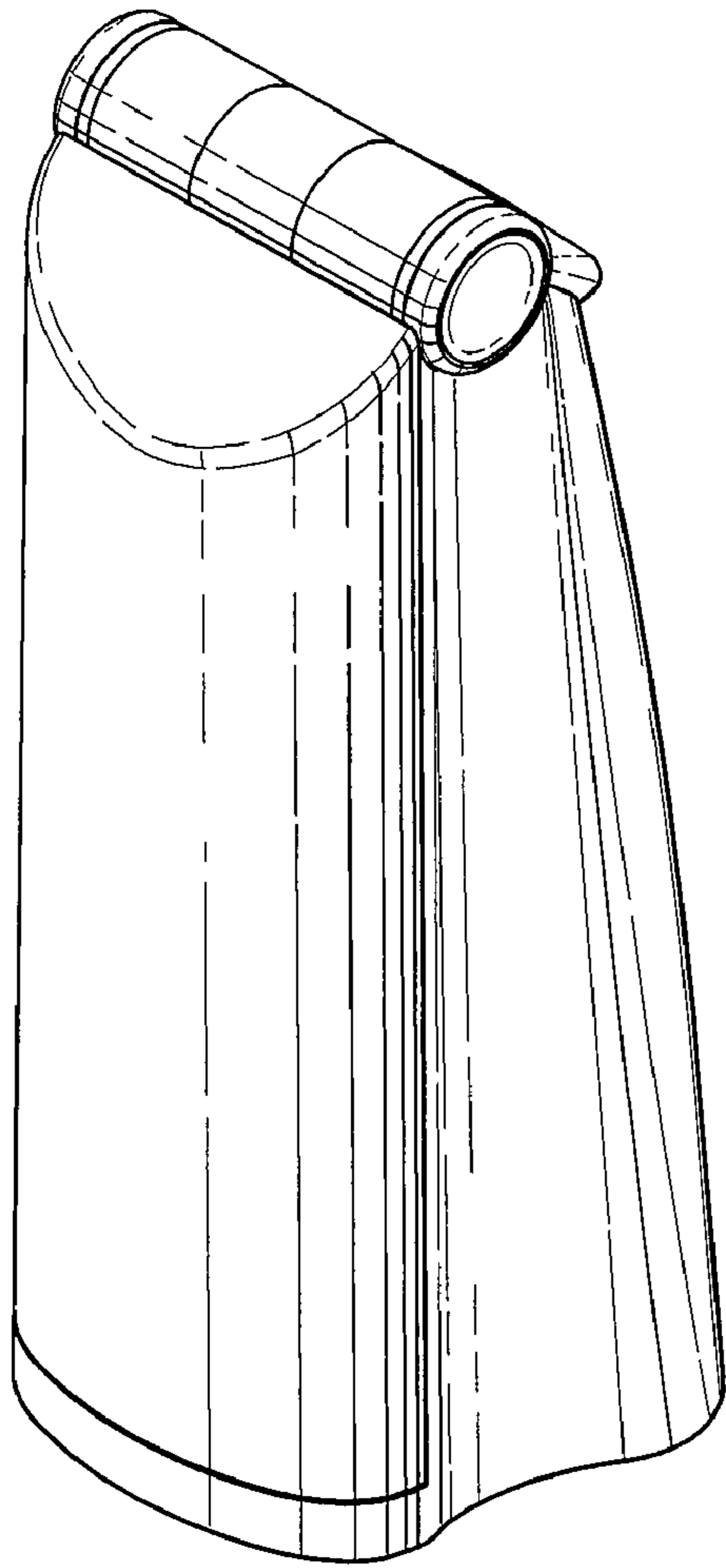

FIG. 1

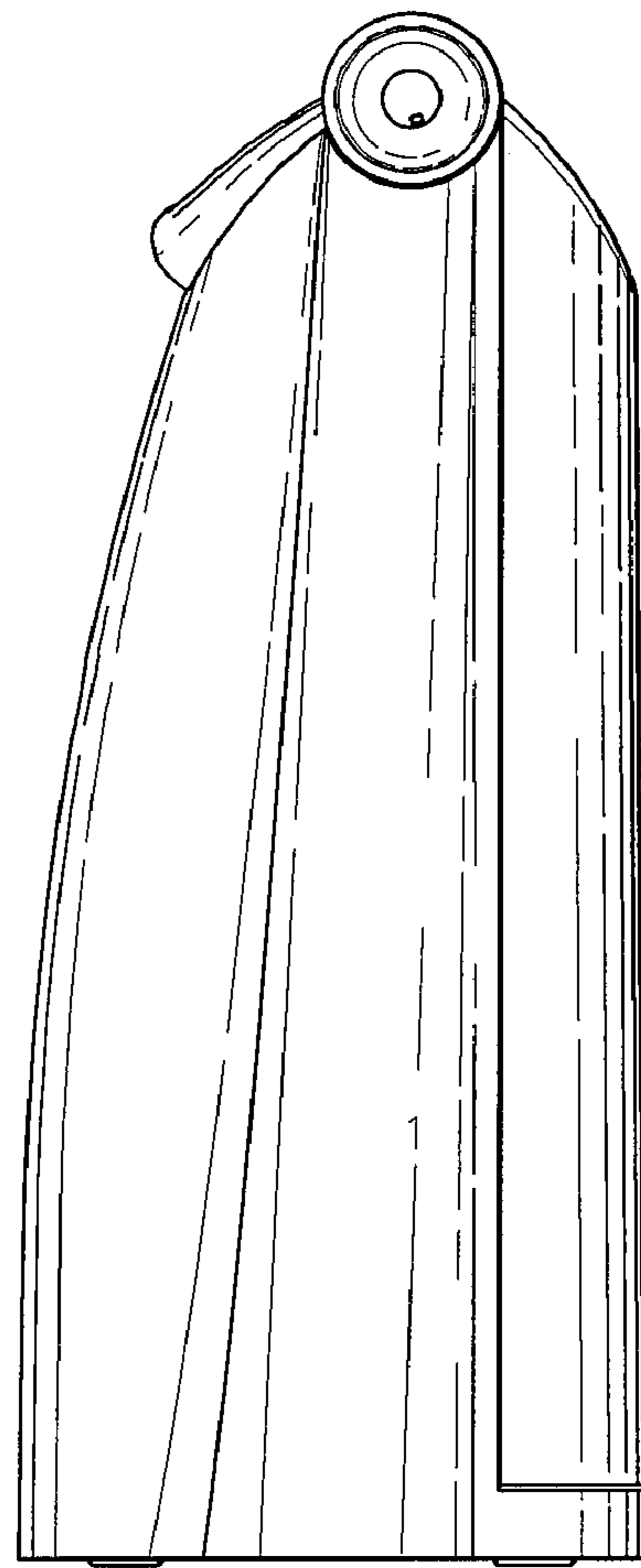

FIG. 2

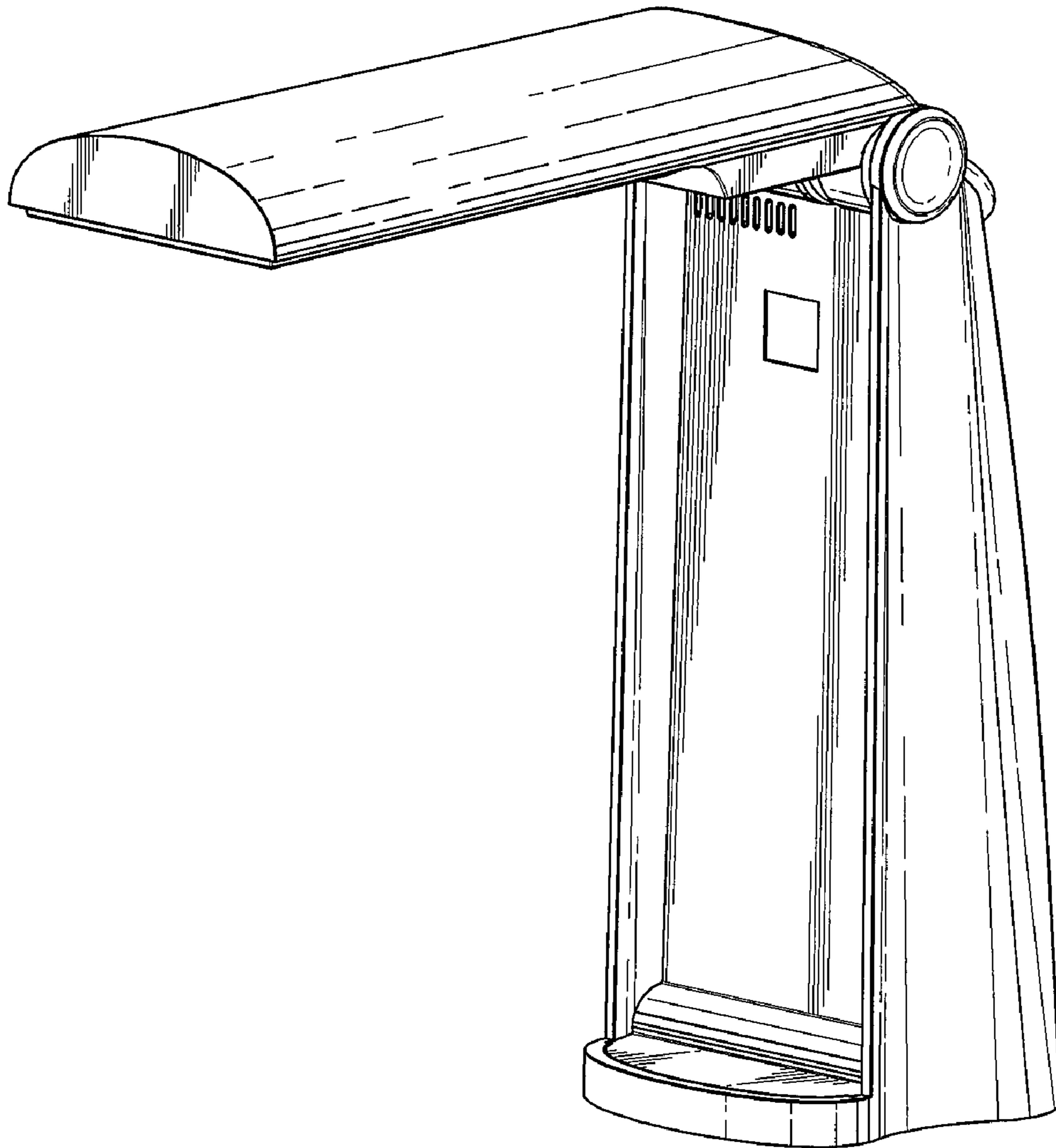

FIG. 3

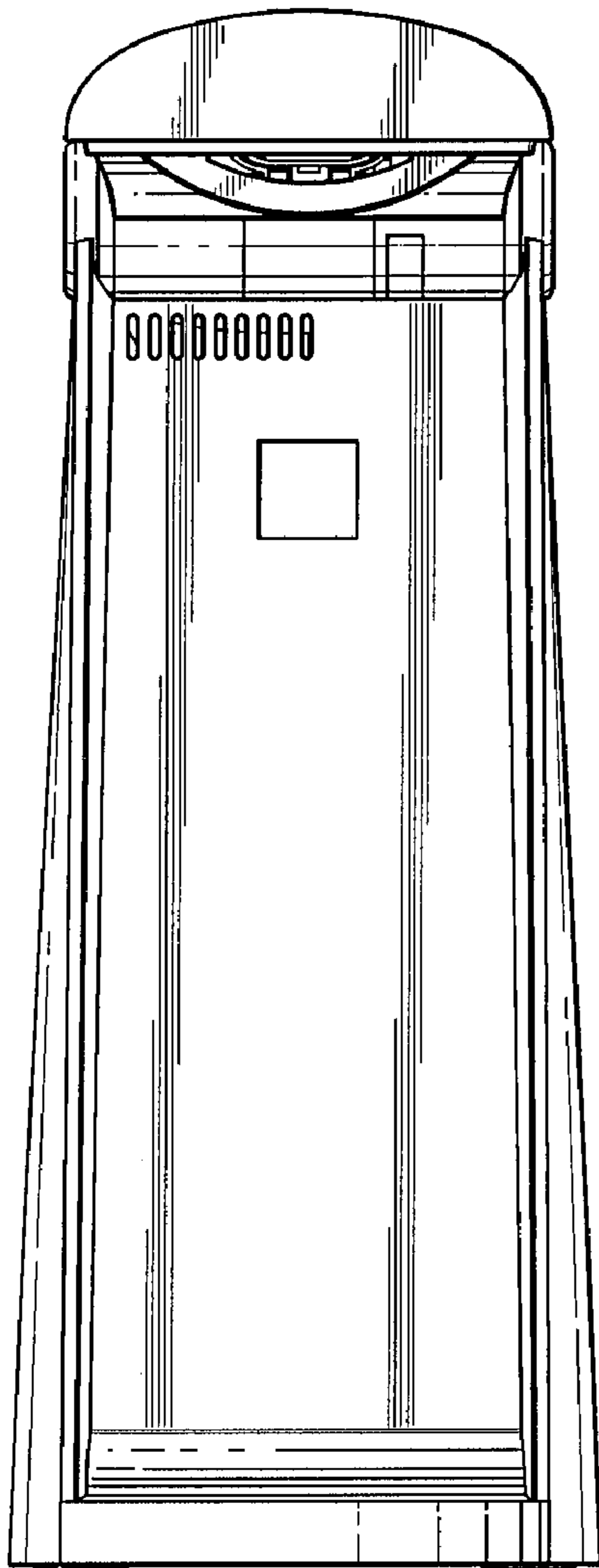

FIG. 4

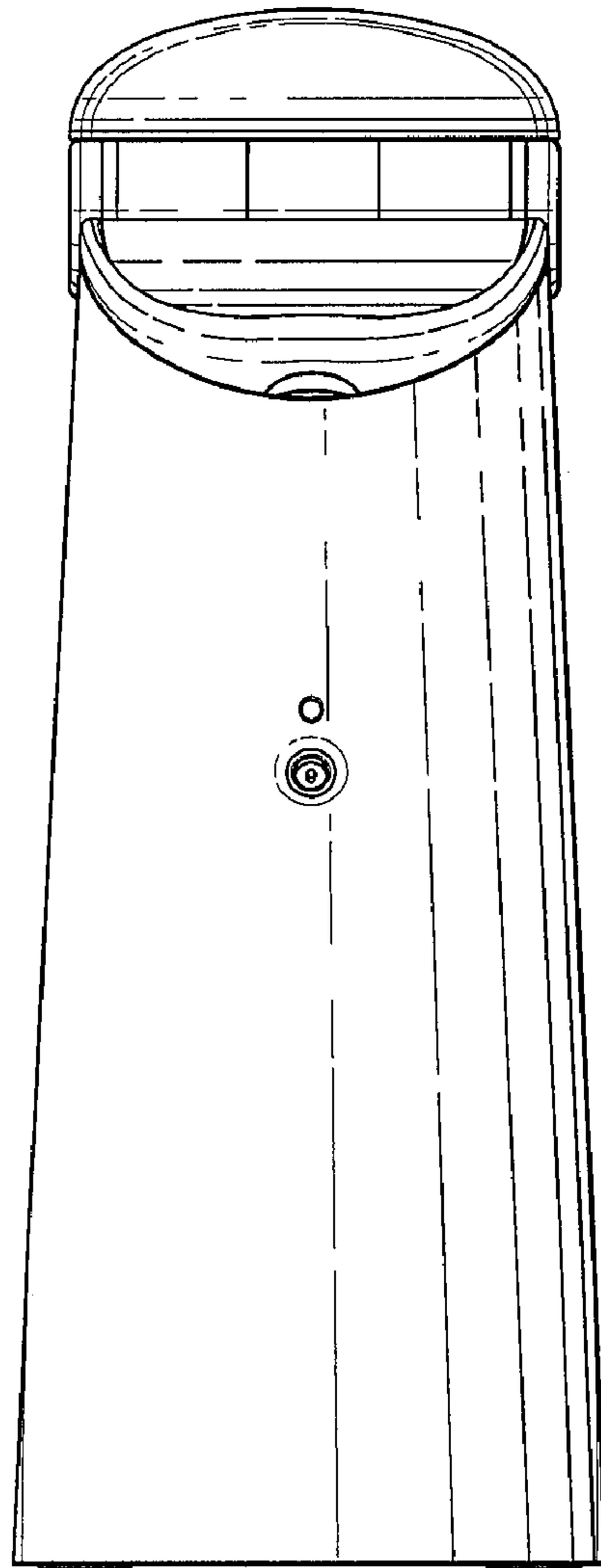

FIG. 5

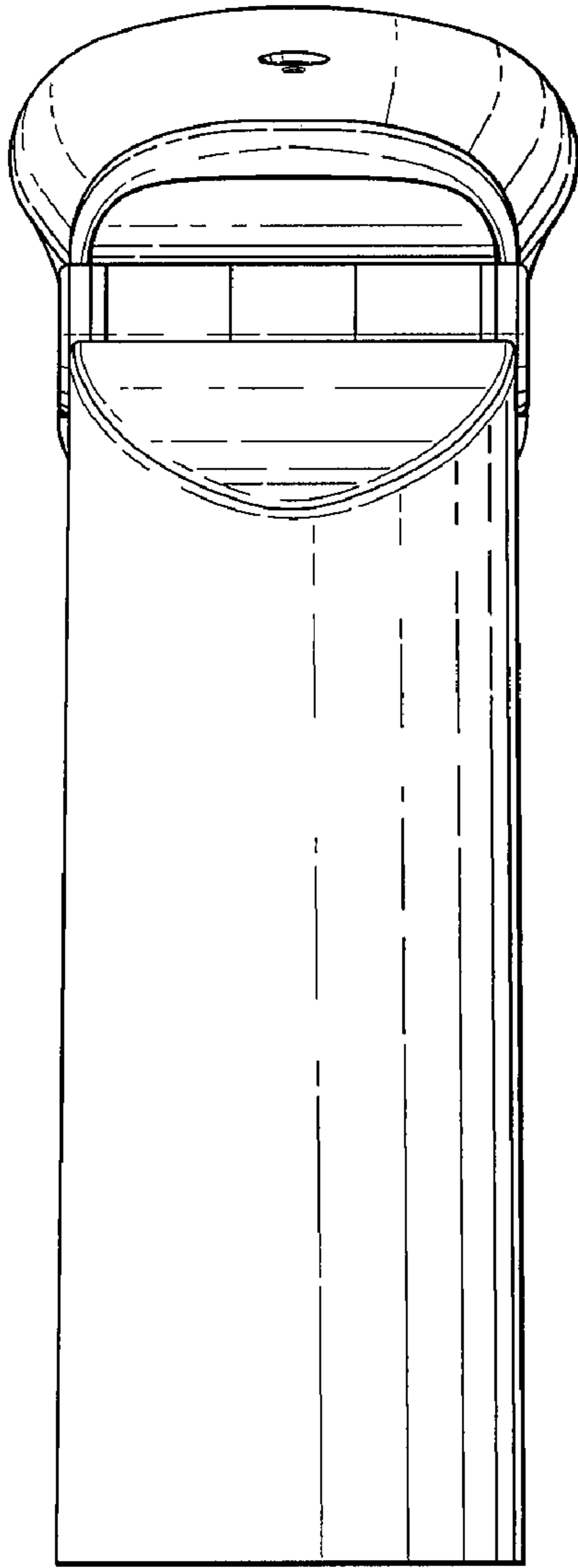

FIG. 6

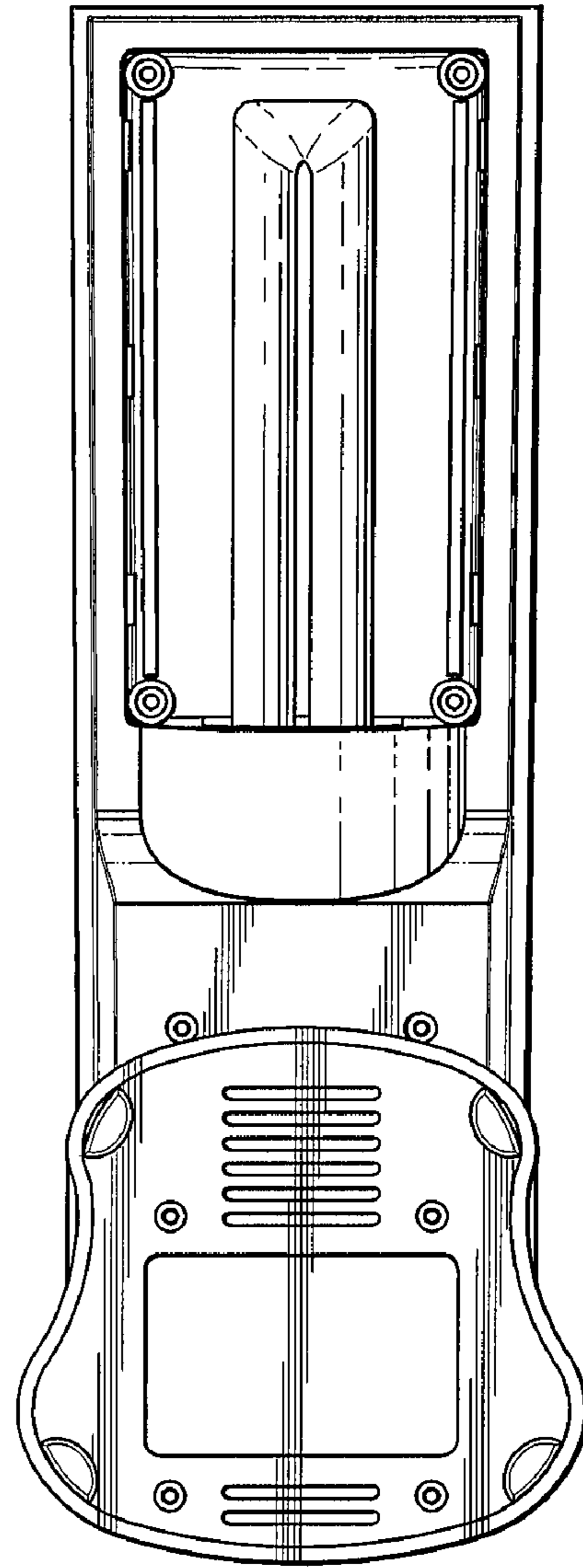

FIG. 7