



US00D596692S

(12) **United States Design Patent**
Couzyn

(10) **Patent No.:** **US D596,692 S**

(45) **Date of Patent:** **** Jul. 21, 2009**

(54) **FOOT PLATE FOR A DIVING FIN**

D415,544 S * 10/1999 Applegate D21/806

(75) Inventor: **Rhys James Couzyn**, 30 Harris Street,
Strathavon, Sandton 2031 (ZA)

* cited by examiner

(73) Assignee: **Rhys James Couzyn**

Primary Examiner—Janice E Seeger

Assistant Examiner—Zenia I Bennett

(**) Term: **14 Years**

(74) *Attorney, Agent, or Firm*—The Webb Law Firm

(21) Appl. No.: **29/293,273**

(57) **CLAIM**

(22) Filed: **Nov. 13, 2007**

The ornamental design of a foot plate for a diving fin, as shown.

(51) **LOC (9) Cl.** **21-01**

(52) **U.S. Cl.** **D21/806**

(58) **Field of Classification Search** D21/769,
D21/770, 801, 803, 804, 806, 807, 810; D2/731,
D2/732; 441/55, 56, 58, 60–66, 68, 69, 72–75,
441/79

See application file for complete search history.

DESCRIPTION

FIG. 1 is a front perspective view of a foot plate for a diving fin in accordance with the present invention;

FIG. 2 is a rear perspective view thereof;

FIG. 3 is a top plan view thereof;

FIG. 4 is a bottom plan view thereof;

FIG. 5 is a right side plan view thereof;

FIG. 6 is a left side plan view thereof;

FIG. 7 is a front plan view thereof; and,

FIG. 8 is a rear plan view thereof.

The broken lines are for environmental purposes only and form no part of the claimed design.

(56) **References Cited**

U.S. PATENT DOCUMENTS

D219,560 S * 12/1970 Chesney D21/806

D266,265 S * 9/1982 Bowden D21/806

4,869,696 A * 9/1989 Ciccotelli 441/61

5,358,439 A * 10/1994 Paolo 441/64

D379,398 S * 5/1997 Garraffa et al. D21/806

1 Claim, 7 Drawing Sheets

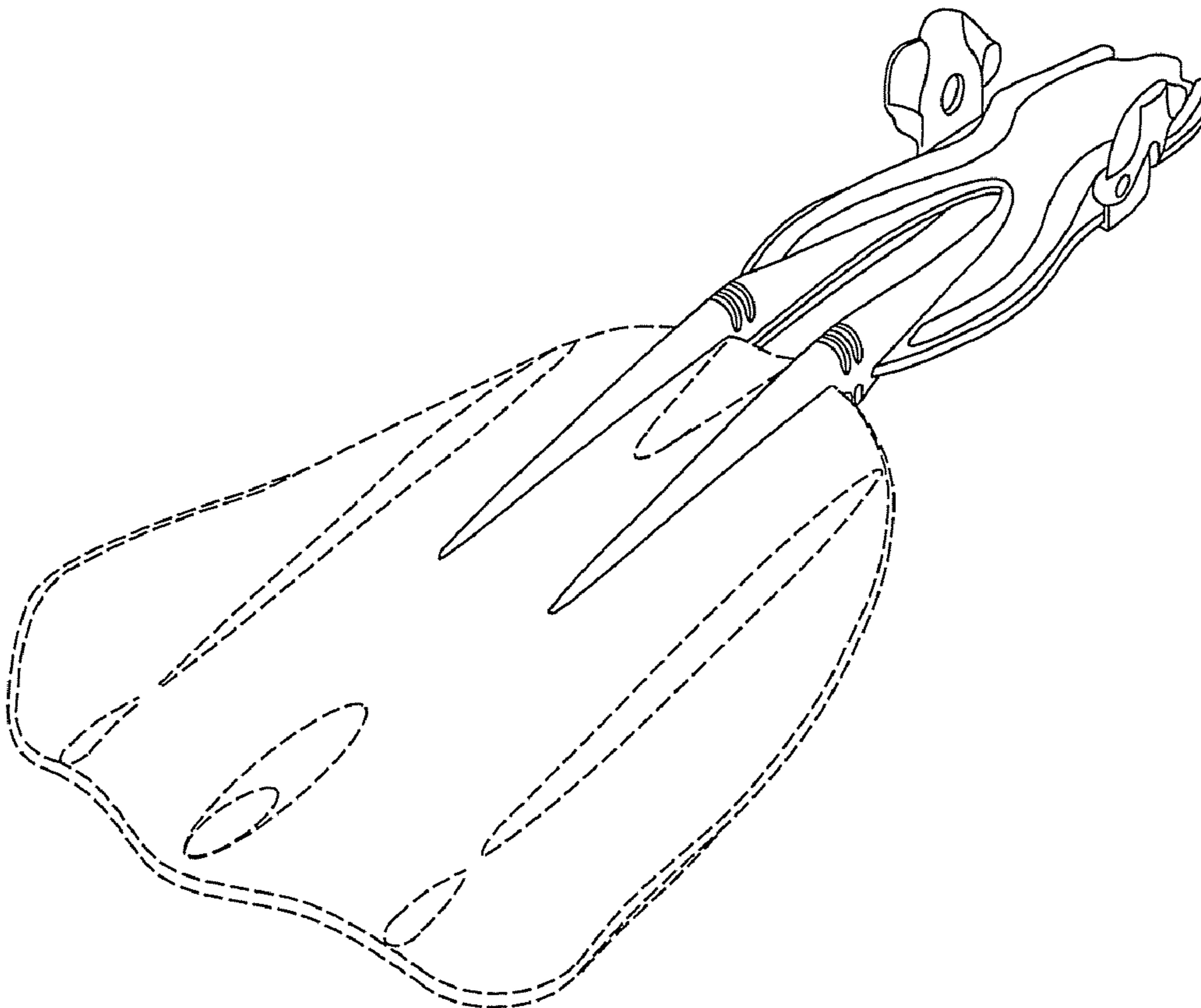

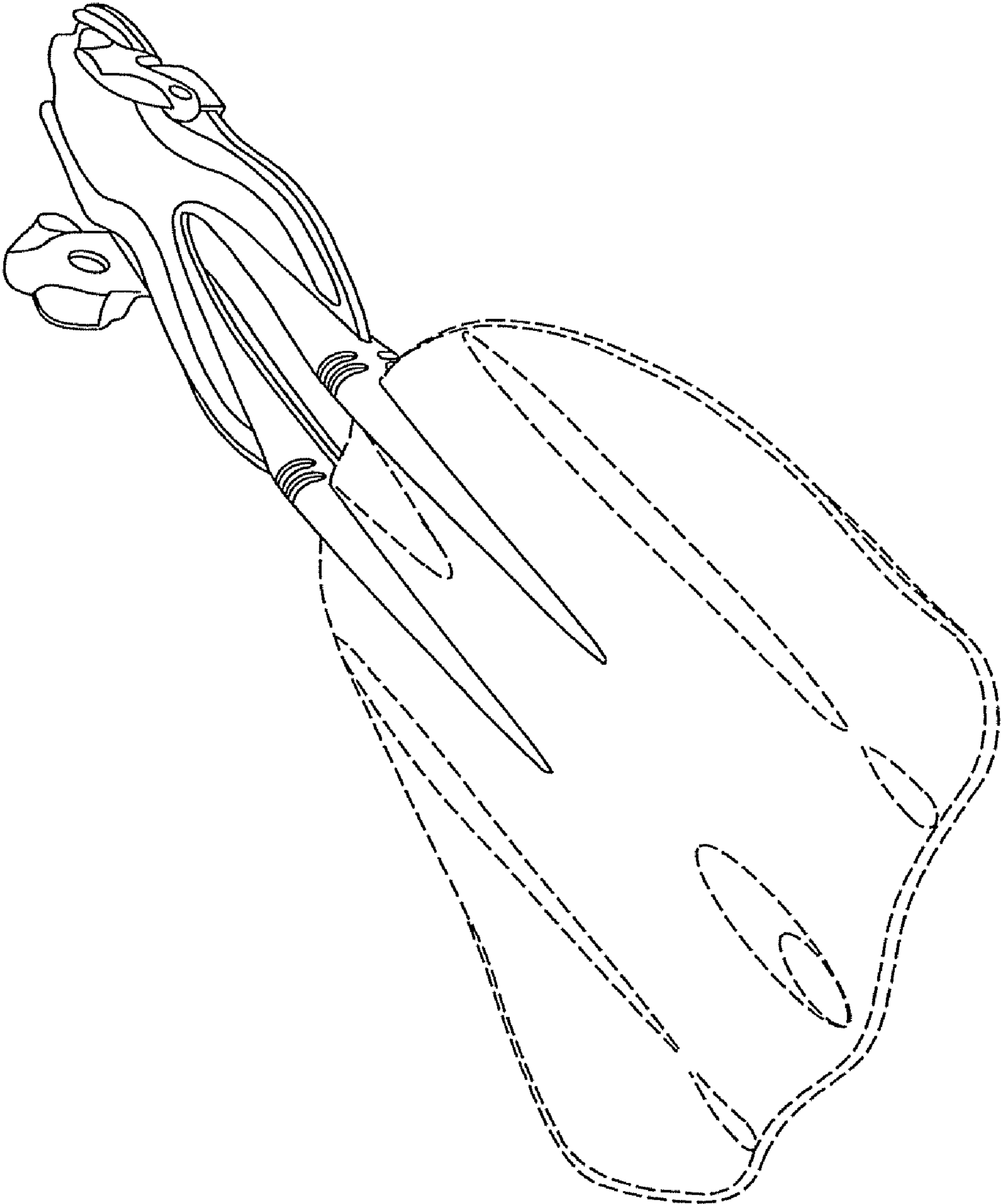

FIG. 1

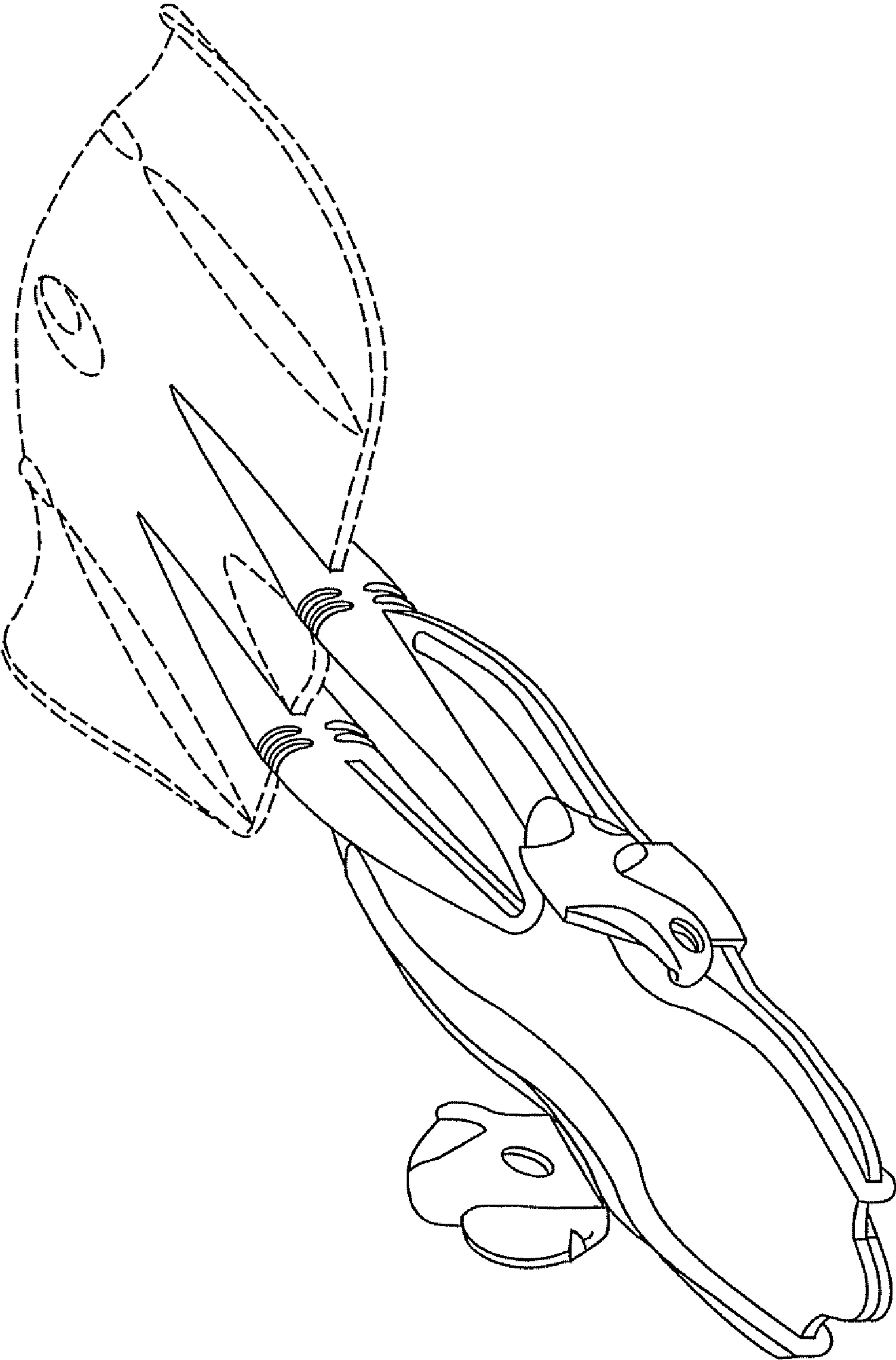

FIG. 2

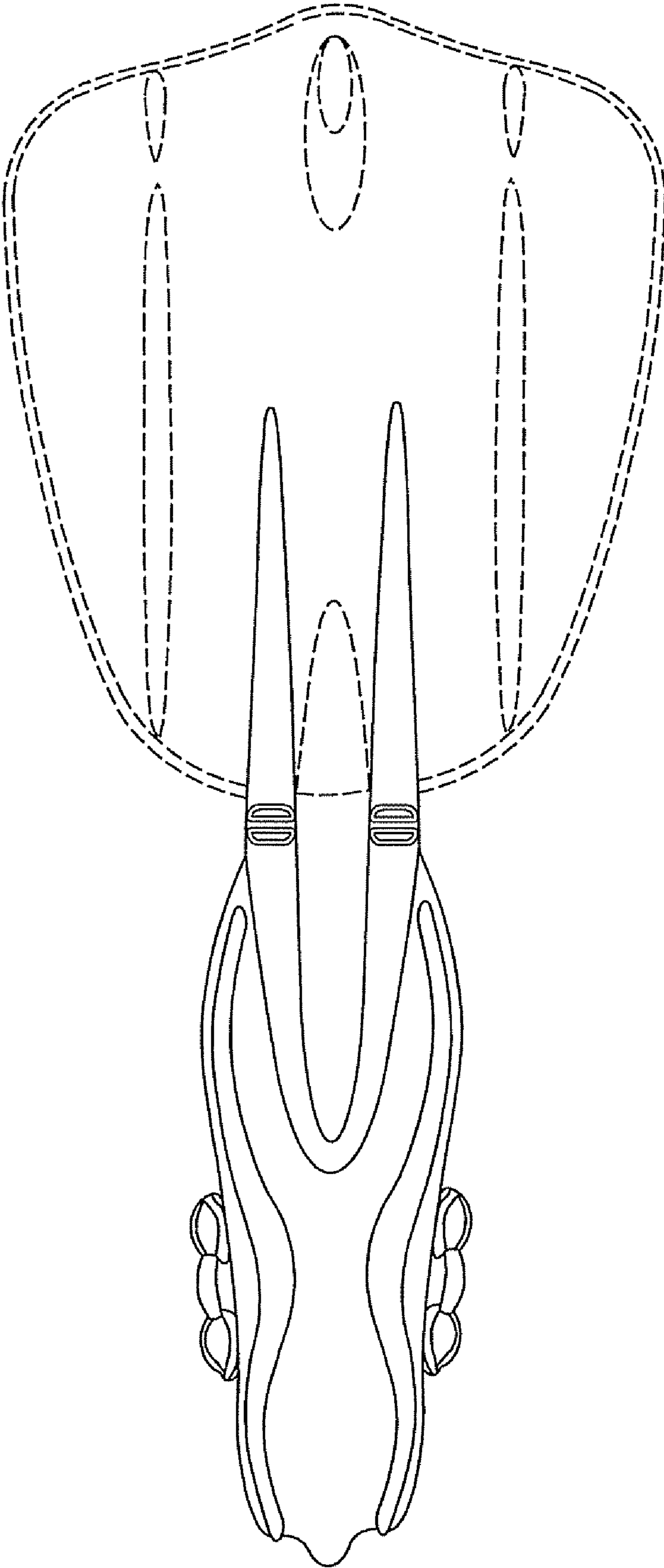

FIG. 3

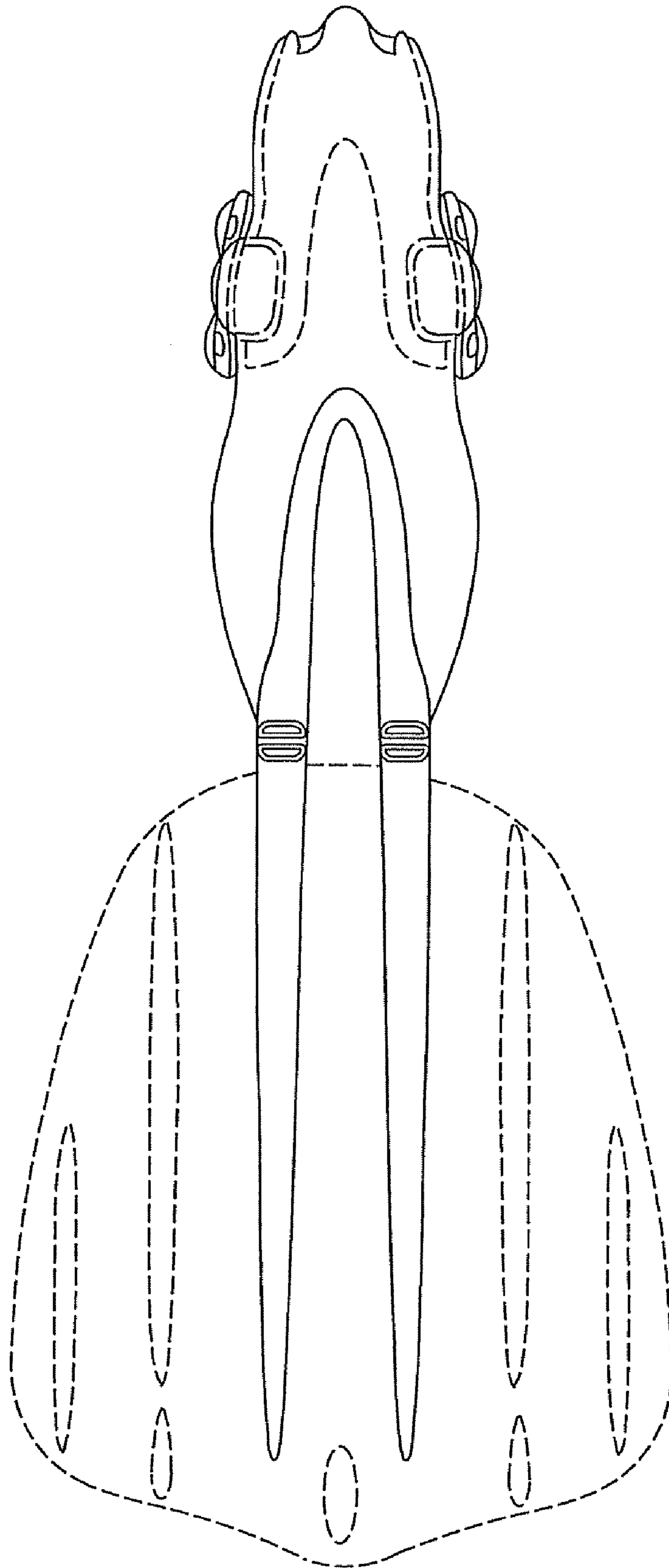

FIG. 4

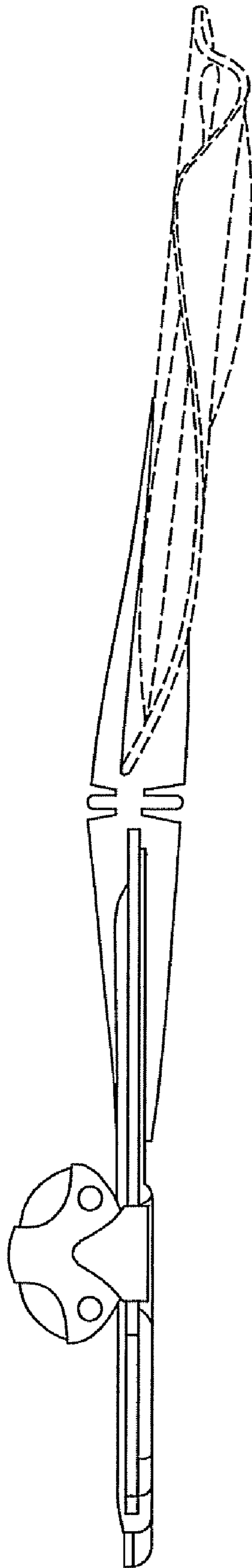

FIG. 5

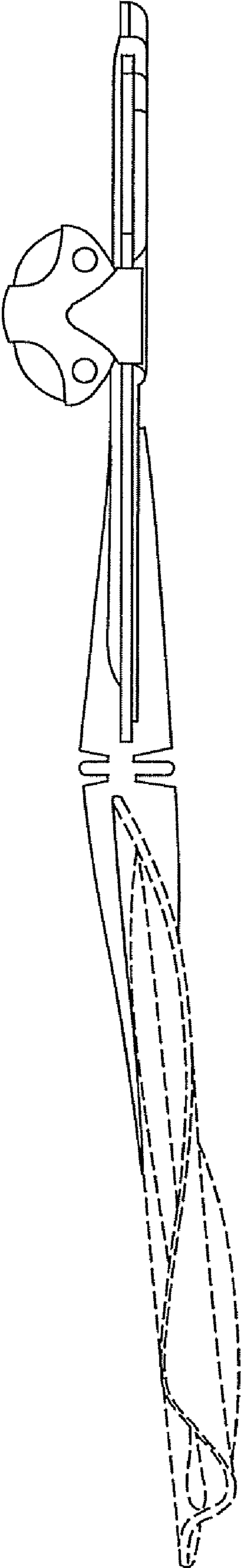

FIG. 6

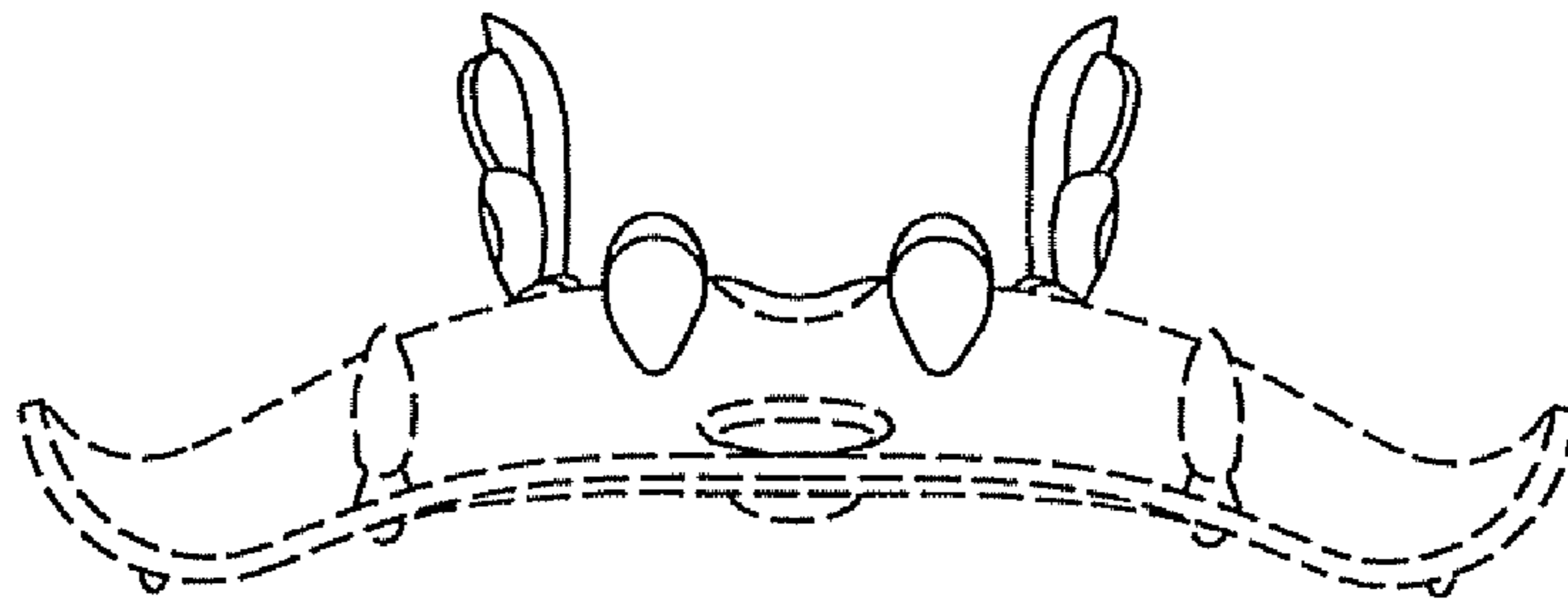

FIG. 7

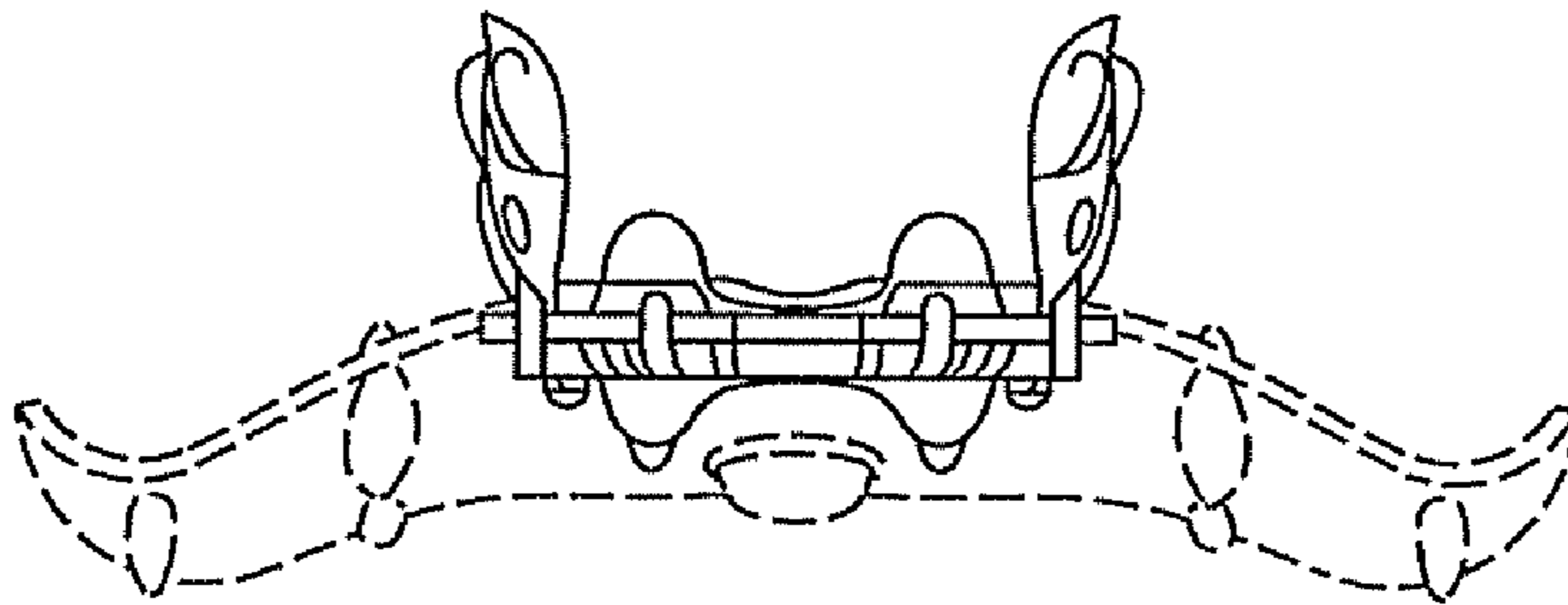

FIG. 8