



US00D596670S

(12) **United States Design Patent**
Baker

(10) **Patent No.:** **US D596,670 S**
(45) **Date of Patent:** **** Jul. 21, 2009**

(54) **FOOTBALL HELMET DESK CADDY**

(76) Inventor: **Adrian Baker**, 5 Diamond Dr.,
Litchfield, IL (US) 62056

(**) Term: **14 Years**

(21) Appl. No.: **29/289,783**

(22) Filed: **Jul. 31, 2007**

(51) **LOC (9) Cl.** **19-02**

(52) **U.S. Cl.** **D19/82**

(58) **Field of Classification Search** D3/259,
D3/271.9; D7/556, 571, 515, 604, 613, 619.2;
D9/455, 632, 668; D19/75, 77-87, 93-97,
D19/99, 100; D29/103, 104, 105, 106; 2/10,
2/410, 411, 414, 416, 422; 206/214, 371,
206/457

See application file for complete search history.

(56) **References Cited**

U.S. PATENT DOCUMENTS

D155,152 S	9/1949	Greenstein et al.	
3,263,236 A *	8/1966	Humphrey	2/9
3,283,336 A *	11/1966	Critser	2/9
D209,219 S	11/1967	Goldstein et al.	
D212,582 S *	11/1968	Feldmann et al.	D29/106
3,486,169 A *	12/1969	Rawlings	2/414
D216,988 S *	3/1970	La Rue	D11/157
D218,349 S	8/1970	Feeney	
D226,335 S	2/1973	Levy et al.	
D232,011 S	7/1974	Denton	
3,889,296 A *	6/1975	Martin	2/9
D239,587 S *	4/1976	Dickstein et al.	D7/564
D243,578 S	3/1977	Danat	
D249,272 S	9/1978	Sommerfeld	
4,326,303 A *	4/1982	Rappleyea	2/411
D267,489 S *	1/1983	Daharsh et al.	D14/143
D270,606 S *	9/1983	McCrary et al.	D7/334
D277,180 S *	1/1985	Paul	D14/143
D279,481 S	7/1985	Adell	
4,586,280 A	5/1986	Dane	
D289,663 S	5/1987	Zucker	
4,689,835 A *	9/1987	Draft et al.	2/424

D292,991 S	12/1987	Adler	
D293,690 S	1/1988	Adler	
D295,424 S	4/1988	Kunz, Jr.	
D310,434 S *	9/1990	Breece	D29/103
D314,492 S	2/1991	Weller et al.	
D319,911 S	9/1991	Tsuji	
D321,845 S *	11/1991	Nys	D11/157
D326,583 S *	6/1992	Lutter et al.	D7/332
D327,775 S	7/1992	Turner	
D332,507 S *	1/1993	Anderson et al.	D29/106
D337,242 S	7/1993	Steinfels, III	

(Continued)

OTHER PUBLICATIONS

Alabama Crimson Tide Mini Football Helmet Desk Caddy, Schutt, 6 pages, 2008, ebay.*

(Continued)

Primary Examiner—Elizabeth A Albert
(74) *Attorney, Agent, or Firm*—Brinks Hofer Gilson & Lione

(57) **CLAIM**

I claim the ornamental design for a football helmet desk caddy, as shown and described.

DESCRIPTION

FIG. 1 is a perspective view of an embodiment of my new design of a football helmet desk caddy;

FIG. 2 is a right side view of my design shown in FIG. 1, where the left side view is a mirror image to the right side view shown in FIG. 2;

FIG. 3 is a front view of my design shown in FIG. 1;

FIG. 4 is a rear view of my design shown in FIG. 1;

FIG. 5 is a top view of my design shown in FIG. 1; and,

FIG. 6 is a bottom view of my design shown in FIG. 1.

The broken lines in the drawings are included for the purpose of illustrating environment and form no part of the claimed design.

1 Claim, 5 Drawing Sheets

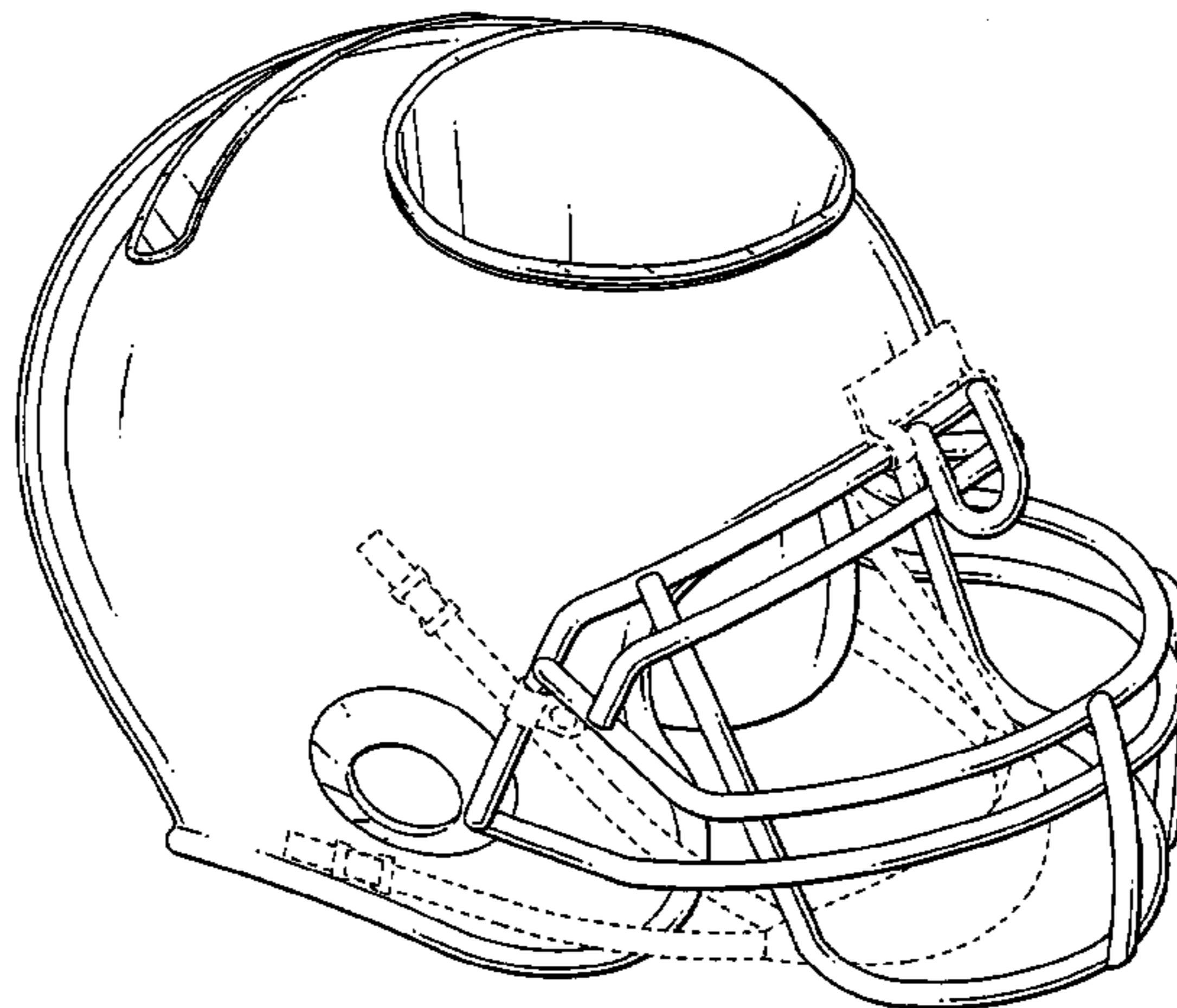

U.S. PATENT DOCUMENTS

D340,072 S 10/1993 Turner
 D340,073 S 10/1993 Turner
 D340,074 S 10/1993 Turner
 D340,075 S 10/1993 Turner
 D340,076 S 10/1993 Turner
 D340,077 S 10/1993 Turner
 D344,659 S 3/1994 Hsu
 D352,211 S * 11/1994 Rucks D7/625
 D357,938 S * 5/1995 Wolff D19/86
 D358,527 S * 5/1995 Danielson et al. D7/332
 5,511,685 A 4/1996 Nelson
 D369,529 S * 5/1996 Blankenburg et al. D7/625
 D379,023 S 4/1997 Drew
 D379,149 S * 5/1997 Powell et al. D9/451
 D382,473 S 8/1997 Egender
 D388,464 S 12/1997 Najbart
 D395,452 S * 6/1998 August D20/7
 D397,580 S * 9/1998 Dunn et al. D7/402
 D401,193 S * 11/1998 Julian D12/162
 5,829,103 A 11/1998 Allen
 5,867,874 A 2/1999 Simpson
 D408,236 S * 4/1999 Rennick D8/38
 5,963,990 A * 10/1999 White 2/424
 D418,293 S * 1/2000 Palmer D3/248
 D420,670 S * 2/2000 Hernandez et al. D14/232
 D425,459 S * 5/2000 Sousa D12/607
 D425,515 S * 5/2000 Suh D14/232
 6,073,271 A * 6/2000 Alexander et al. 2/413
 6,073,798 A 6/2000 Rosenhain
 D430,214 S 8/2000 Palmer
 D434,607 S * 12/2000 Hansen D7/606
 D443,846 S * 6/2001 Aldridge D11/125
 D458,639 S 6/2002 Anderson
 D461,152 S * 8/2002 Schmitt D12/197
 6,438,762 B1 * 8/2002 Jenkins 2/411
 D467,119 S * 12/2002 McGargill D7/332
 D471,060 S * 3/2003 Salsman D7/392.1
 D472,912 S * 4/2003 Allen D16/135
 D477,270 S * 7/2003 Bowers D12/400
 D503,311 S * 3/2005 Strobel et al. D7/604
 D504,003 S 4/2005 Lee
 D504,156 S 4/2005 Galotti et al.
 D507,181 S * 7/2005 Malik D9/451
 6,923,322 B2 8/2005 Lenker
 D509,928 S * 9/2005 Barnoski D29/107
 D520,673 S * 5/2006 Wu D27/148
 D526,450 S * 8/2006 Taylor et al. D30/111
 7,096,513 B1 * 8/2006 Kress 2/410
 7,137,151 B2 11/2006 Keech
 D534,347 S 1/2007 Prentice
 D535,157 S 1/2007 Hoehne

D566,461 S * 4/2008 McDonald D7/398

OTHER PUBLICATIONS

Poly Resin Football Helmet Pen Holder, 1 page, 2008, Alibaba.com.*
 Texas Longhorns Mini Helmet Desk Caddy, 2 pages, 2008, Football Fanatics Inc.*
 "Artisan Sterling Silver Basketball Pen Holder," <<http://caspi-silver.co.il/nconfigout.asp?psn=750&scat=192>> last visited Jul. 31, 2007.
 "Baseball/Basketball Pen-Pencil Holder," <http://soccerstuffmore.com/product_detail.asp?id=452&CategoryID=1> last visited Jul. 31, 2007.
 "Basketball Coolie Cup," <http://catalog.prographicsportswear.com/product_info.php?products_id=75&SID&catid=28> last visited Jul. 31, 2007.
 "Basketball Pen Holder Statue," <<http://www.milliesplastercraft.com/Product.asp?pid=1037>> last visited Jul. 31, 2007.
 "Basketball Pen Holder," <<http://www.sweetpeachesbedding.com/basketball-pencil-holder-p23060-c852.html>> last visited Jul. 31, 2007.
 "Basketball Pencil Holder," <http://www.nxtgeneration.net/basketball_pencil_holder.html> last visited Jul. 31, 2007.
 "Denver Broncos Official Online Pro Shop-Football Snack Helmet," <http://denverbroncosproshop.com/main_detail.cfm?nProductID=4635&sAuxTitle=Football%20Snack%20Helmet> last visited Jul. 31, 2007.
 "First Serve In," <<http://www.firstservein.com/images/td006.jpg>> last visited Jul. 31, 2007.
 "Mini Basketball Pencil Holder," <<http://withaname.com/ProductPage/ZoomPage.php?PageType=CH7500BK>> last visited Jul. 31, 2007.
 "New England Patriots-NFL Helmet Desk Organizer," <<http://www.rivercitysports.com/final-04.cfm?league=NFL&team=NEW%ENGLAND%20PATRIOTS&category=SOUVENIRS&subcategory=HOME%20AND%20OFFICE&proddesc=NFL%20Helmet%20Desk%20Organizer&colors=>>> last visited Jul. 31, 2007.
 "Ohio State Buckeyes Helmet Toothbrush Holder," <http://www.footballfanatics.com/COLLEGE_Ohio_State_Buckeyes_Home_Office_And_School/Ohio_State_Buckeyes_Helmet_Toothbrush_Holder> last visited Jul. 31, 2007.
 "Personalized Mini Football Pencil Holder," <<http://www.toyscamp.com/viewproduc.asp?productId=GGCH7200>> last visited Jul. 31, 2007.
 "San Diego Padres MLB Replica Left Flap Mini Batting Helmet From Riddell," <<http://www.onlinesports.com/pages/I,RID-padres.html>> last visited Jul. 31, 2007.
 "Soccer Ball Pencil Holder," <http://nxtgeneration.net/soccer_ball_pencil_holder.html> last visited Jul. 31, 2007.

* cited by examiner

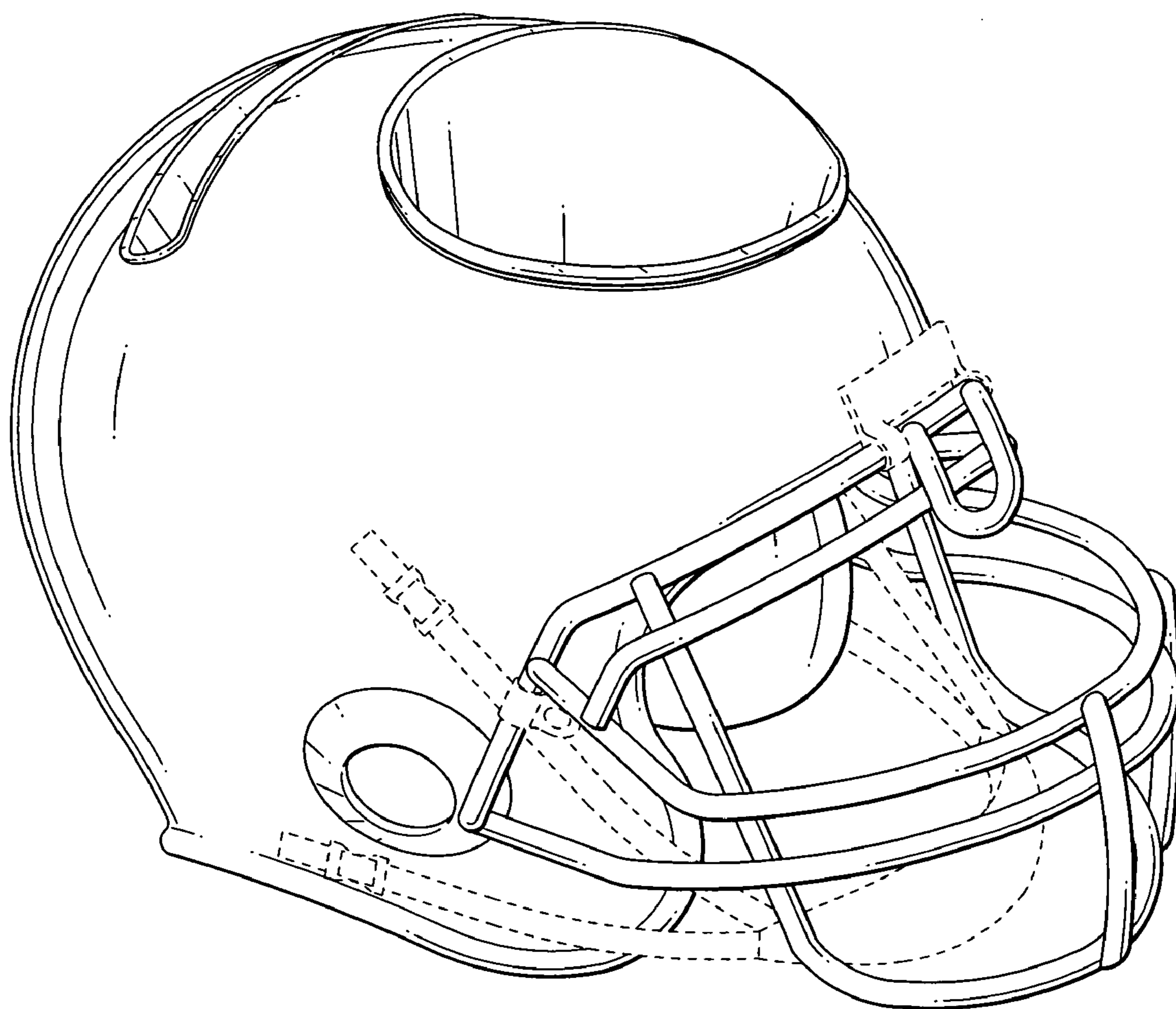

FIG. 1

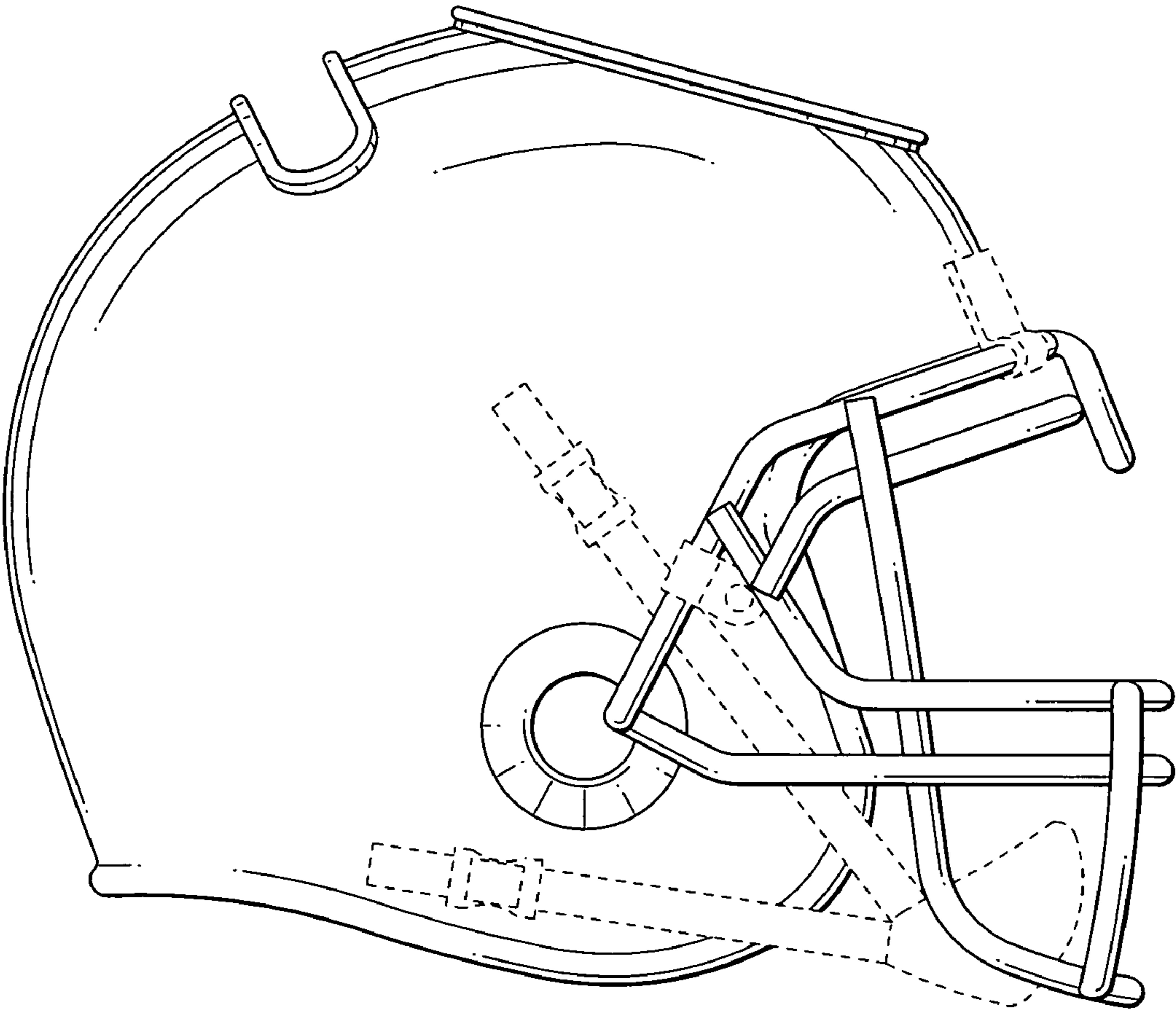

FIG. 2

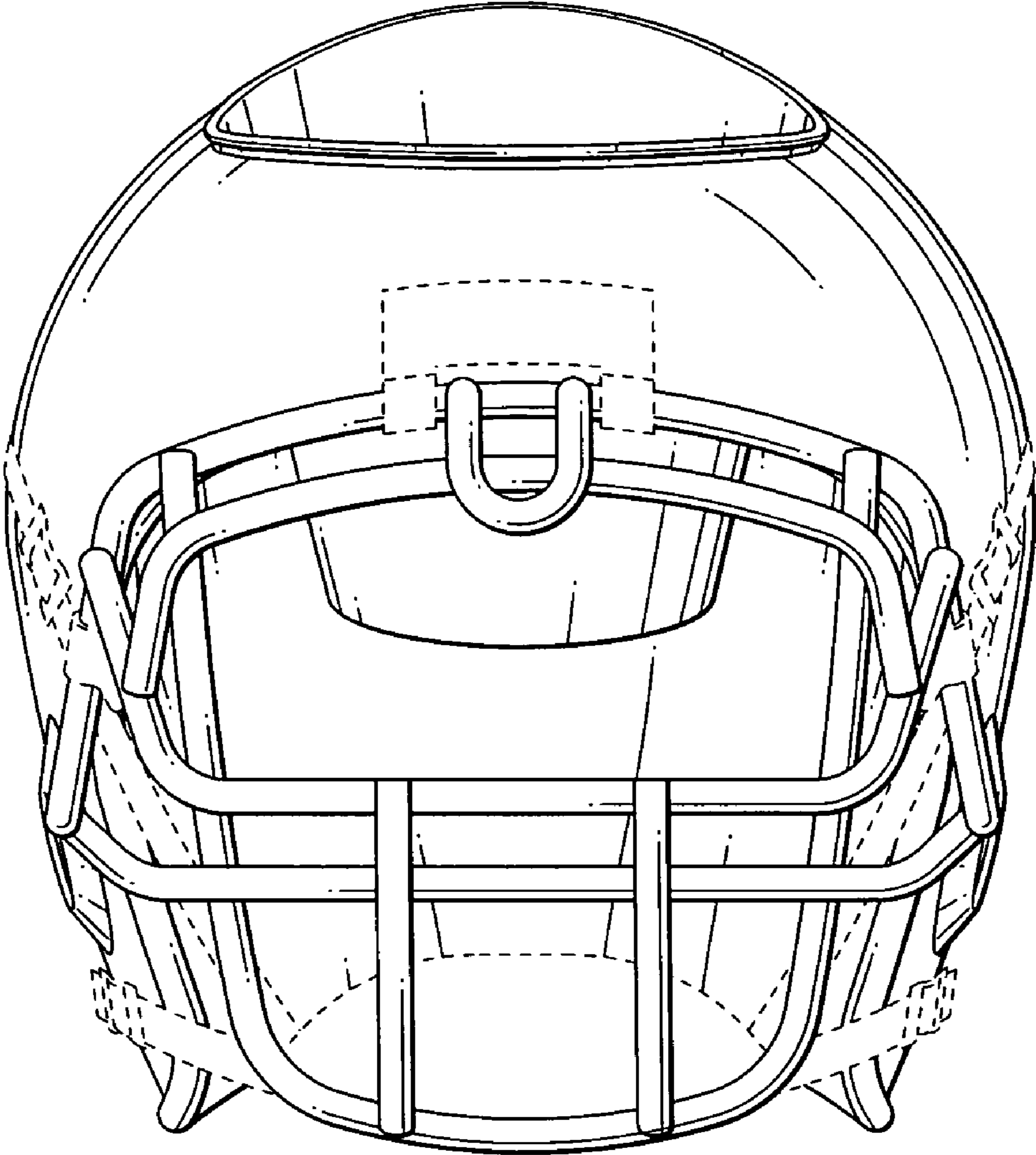

FIG. 3

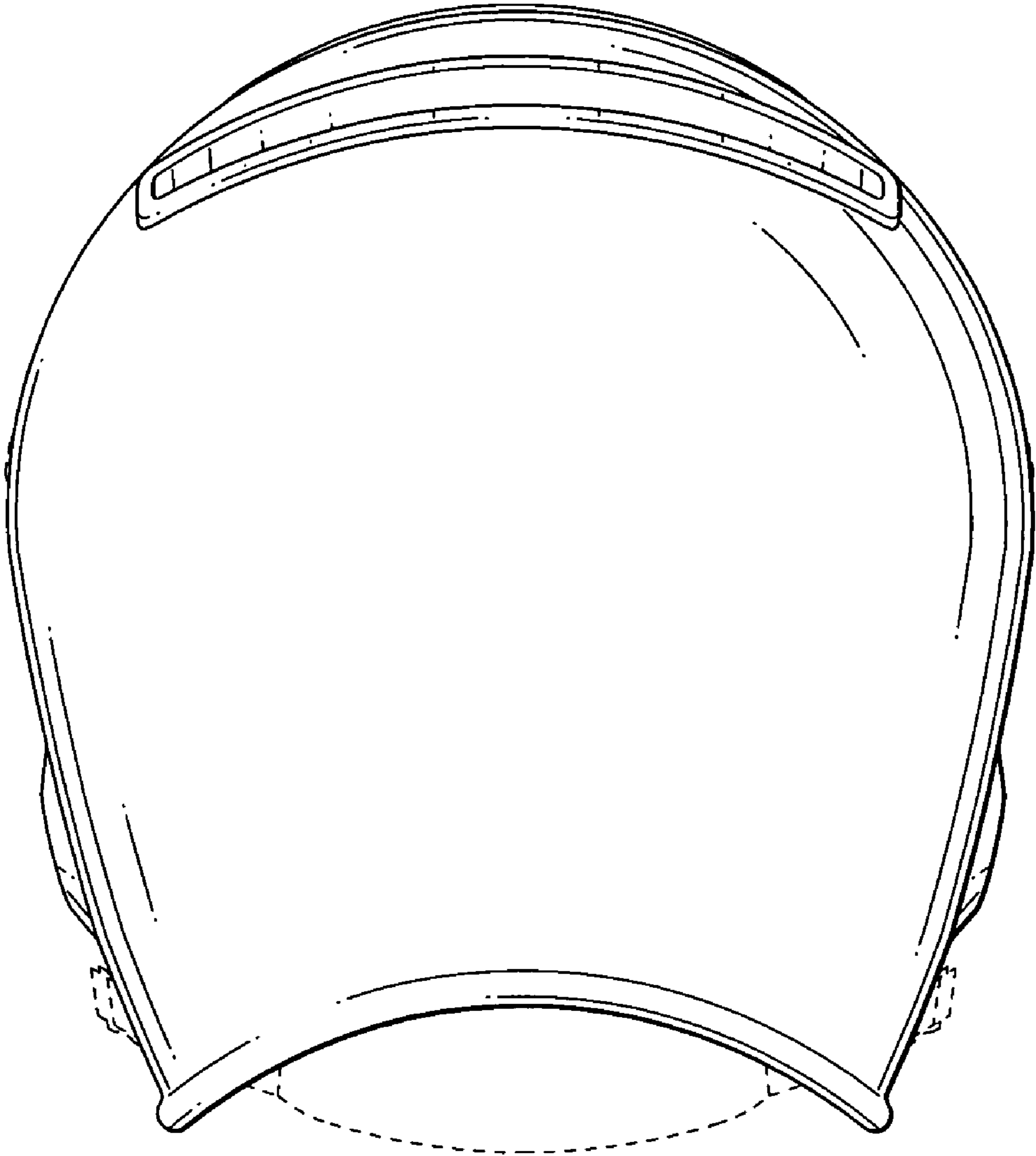

FIG. 4

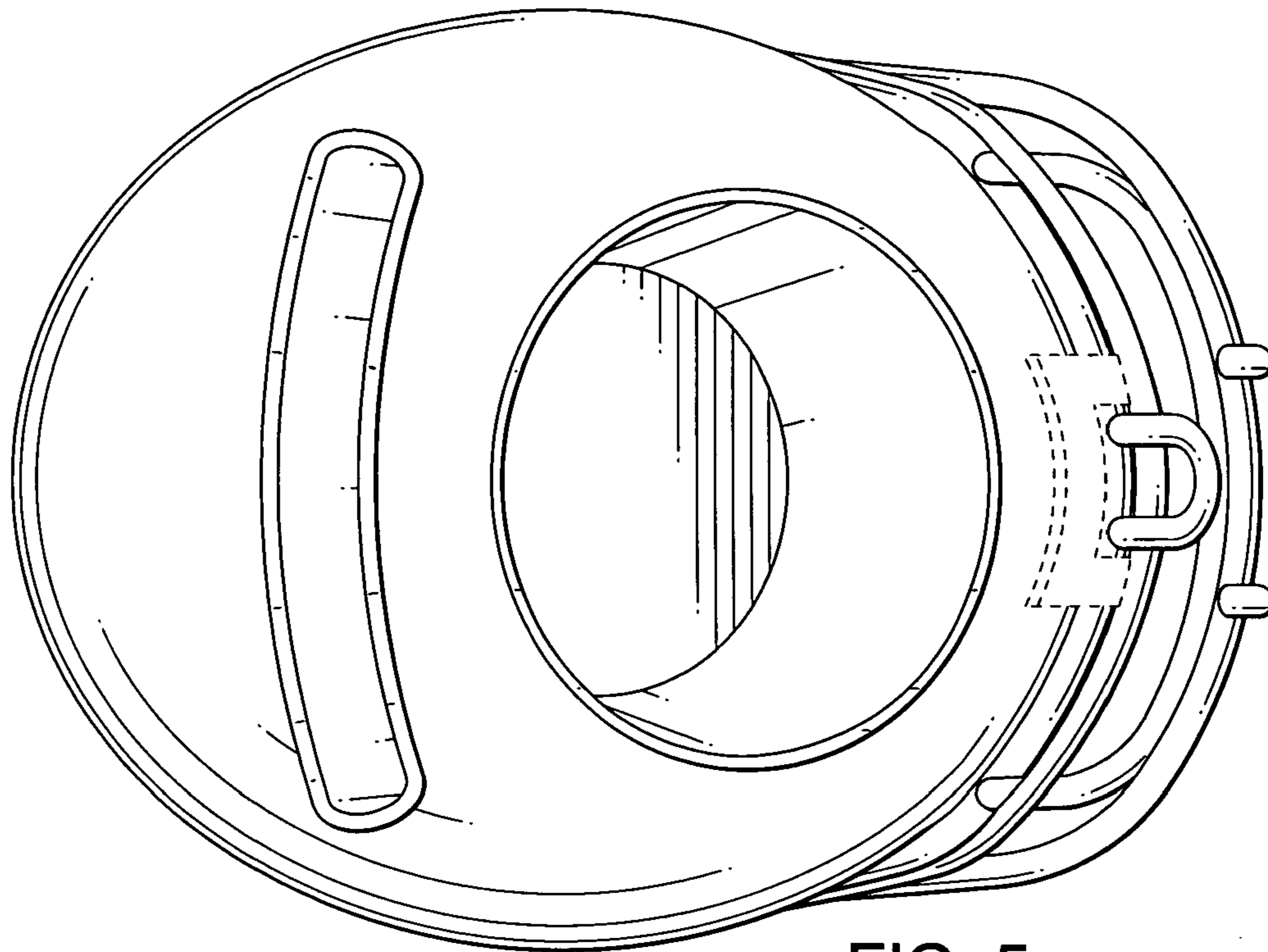

FIG. 5

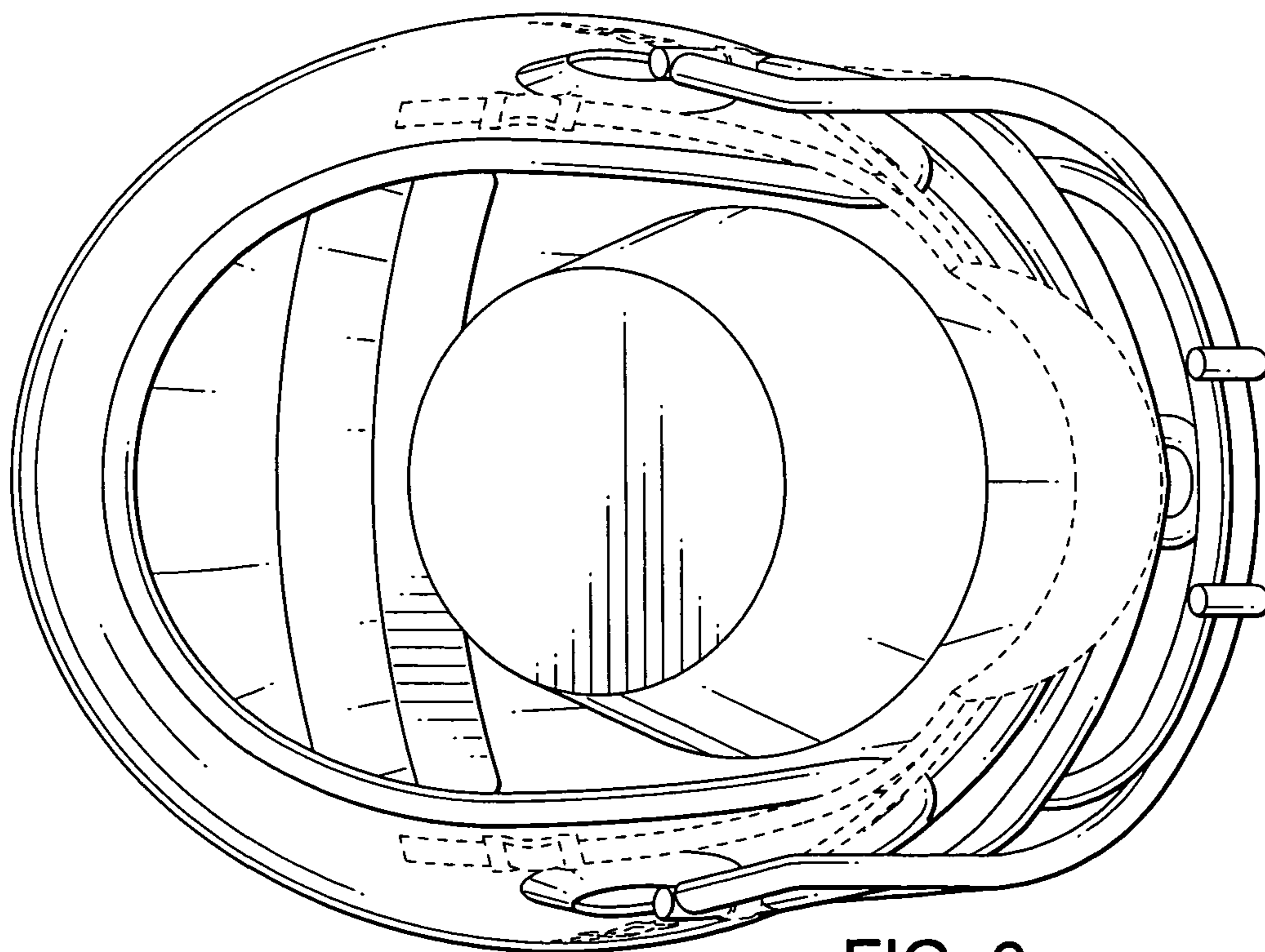

FIG. 6