



US00D596638S

(12) **United States Design Patent**  
**Morishita et al.**

(10) **Patent No.:** **US D596,638 S**  
(45) **Date of Patent:** **\*\* Jul. 21, 2009**

(54) **PORTABLE COMPUTER**

(75) Inventors: **Yoshihito Morishita**, Osaka (JP); **Akira Iwamoto**, Osaka (JP); **Jun Sato**, Osaka (JP)

(73) Assignee: **Panasonic Corporation**, Osaka (JP)

(\*\*) Term: **14 Years**

(21) Appl. No.: **29/307,998**

(22) Filed: **May 22, 2008**

(30) **Foreign Application Priority Data**

Nov. 22, 2007 (JP) ..... 2007-032170

(51) **LOC (9) Cl.** ..... **14-02**

(52) **U.S. Cl.** ..... **D14/439; D14/315**

(58) **Field of Classification Search** ..... D14/315-327,  
D14/348, 349, 351, 353-355, 385, 388-398,  
D14/432-434, 439-447; 361/679.01, 679.02,  
361/679.07, 679.08, 679.09, 679.1, 679.18,  
361/679.19, 679.2, 679.26, 679.27, 679.28,  
361/679.31, 679.55, 679.57, 679.58  
See application file for complete search history.

(56) **References Cited**

**U.S. PATENT DOCUMENTS**

D361,553 S \* 8/1995 De Iuliis ..... D14/318  
D397,328 S 8/1998 Ide et al.  
5,793,355 A \* 8/1998 Youens ..... 345/157

(Continued)

**FOREIGN PATENT DOCUMENTS**

JP D1167389 3/2003  
JP D1209267 6/2004  
JP D1259272 12/2005

**OTHER PUBLICATIONS**

U.S. Appl. No. 29/308,003, filed May 22, 2008.

*Primary Examiner*—Cathron C Brooks

*Assistant Examiner*—Deanna Fluegeman

(74) *Attorney, Agent, or Firm*—Brinks Hofer Gilson & Lione

(57) **CLAIM**

We claim the ornamental design for a portable computer, as shown and described.

**DESCRIPTION**

FIG. 1 is a top perspective view of the portable computer of the present invention;

FIG. 2 is a top view thereof;

FIG. 3 is a front view thereof;

FIG. 4 is a first side view thereof;

FIG. 5 is a second side view thereof;

FIG. 6 is a top perspective view of the portable computer of the present invention, shown at an enlarged scale, and with the unclaimed environment removed for clarity of illustration;

FIG. 7 is a top view thereof;

FIG. 8 is a front view thereof;

FIG. 9 is a rear view thereof;

FIG. 10 is a bottom view thereof;

FIG. 11 is a first side view thereof;

FIG. 12 is a second side view thereof;

FIG. 13 is a cross-section view taken along the line 13—13 of FIG. 8;

FIG. 14 is a cross-section view taken along the line 14—14 of FIG. 7;

FIG. 15 is a cross-section view taken along the line 15—15 of FIG. 7; and,

FIG. 16 is a cross-section view taken along the line 16—16 of FIG. 7.

The broken line showing of the portable computer is included for the purpose of illustrating environment and forms no part of the claimed design.

**1 Claim, 6 Drawing Sheets**

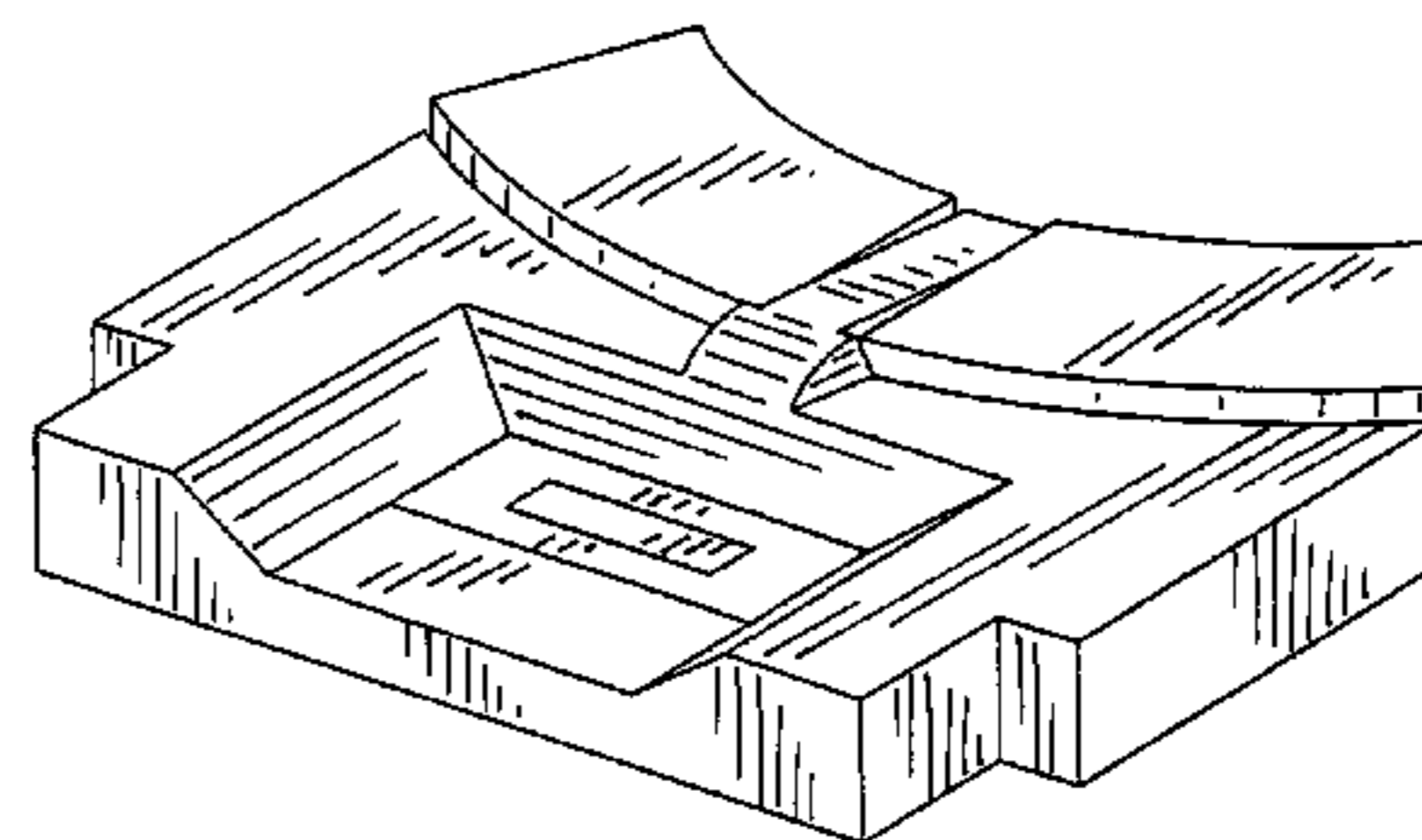
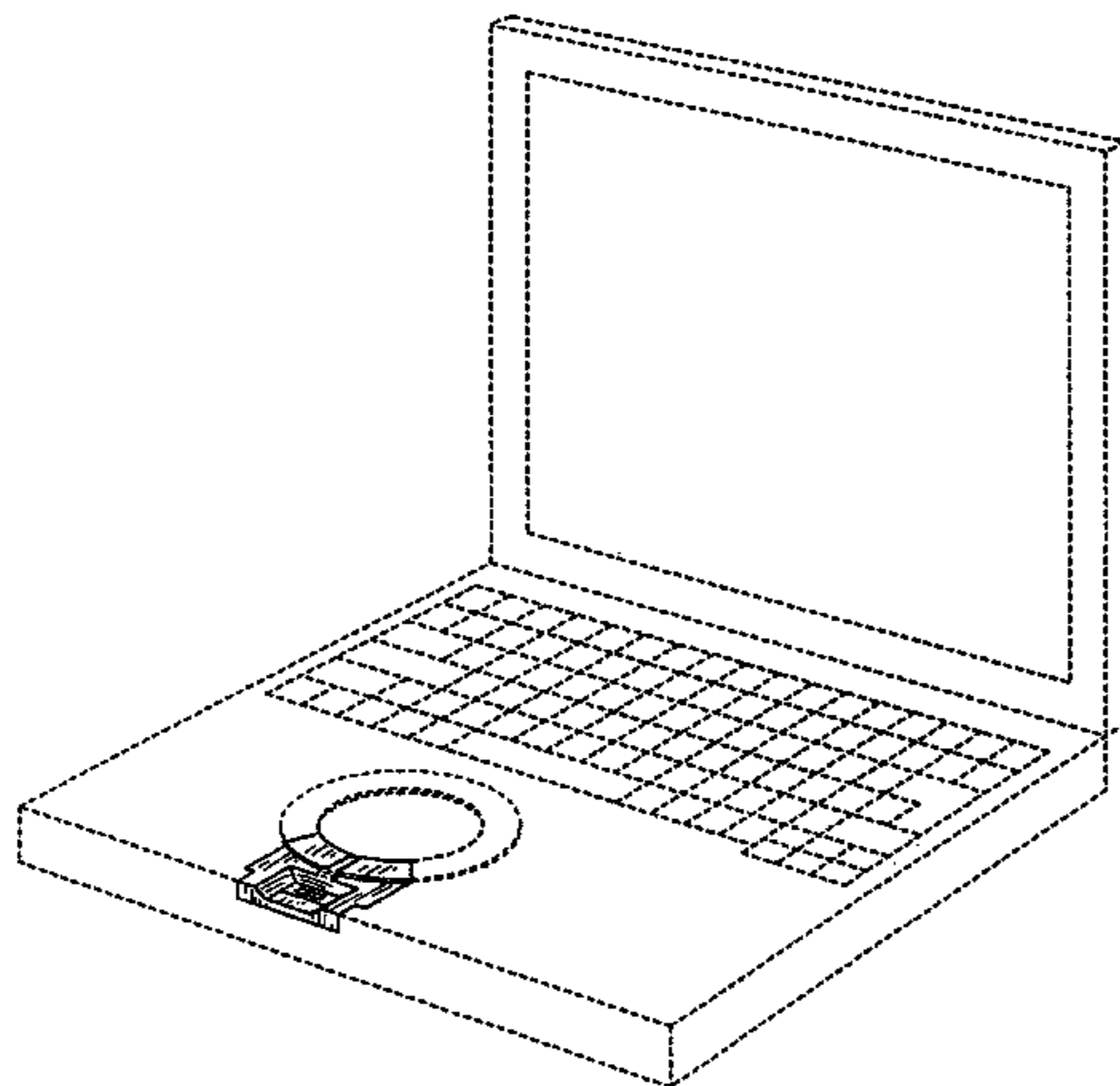

# US D596,638 S

Page 2

---

## U.S. PATENT DOCUMENTS

D410,916 S *	6/1999	Oba .....	D14/432	D482,029 S *	11/2003	Yoneda .....	D14/323
D415,474 S *	10/1999	Goto .....	D14/318	D490,418 S *	5/2004	Liao .....	D14/318
6,118,653 A *	9/2000	Kim .....	361/679.26	D492,301 S *	6/2004	Lu .....	D14/318
6,166,722 A *	12/2000	Kawabe et al. ....	345/169	6,847,350 B2 *	1/2005	Van Brocklin et al. ....	345/157
6,205,021 B1 *	3/2001	Klein et al. ....	D14/318	6,933,921 B2 *	8/2005	Yasuda et al. ....	361/679.1
D444,464 S *	7/2001	Amano et al. ....	D14/322	D516,065 S *	2/2006	Lee et al. ....	D14/317
D449,307 S *	10/2001	Amano et al. ....	D14/455	D523,430 S *	6/2006	Lin .....	D14/318
D452,861 S *	1/2002	Ogasawara .....	D14/322	7,298,359 B2 *	11/2007	Kim et al. ....	345/158
D462,967 S *	9/2002	Suzuki .....	D14/439	D568,308 S *	5/2008	Nakagawa .....	D14/315
D473,564 S *	4/2003	Yano .....	D14/455	D580,438 S *	11/2008	Kuchler .....	D14/385
D478,089 S *	8/2003	Yokota .....	D14/455				

\* cited by examiner

FIG. 1

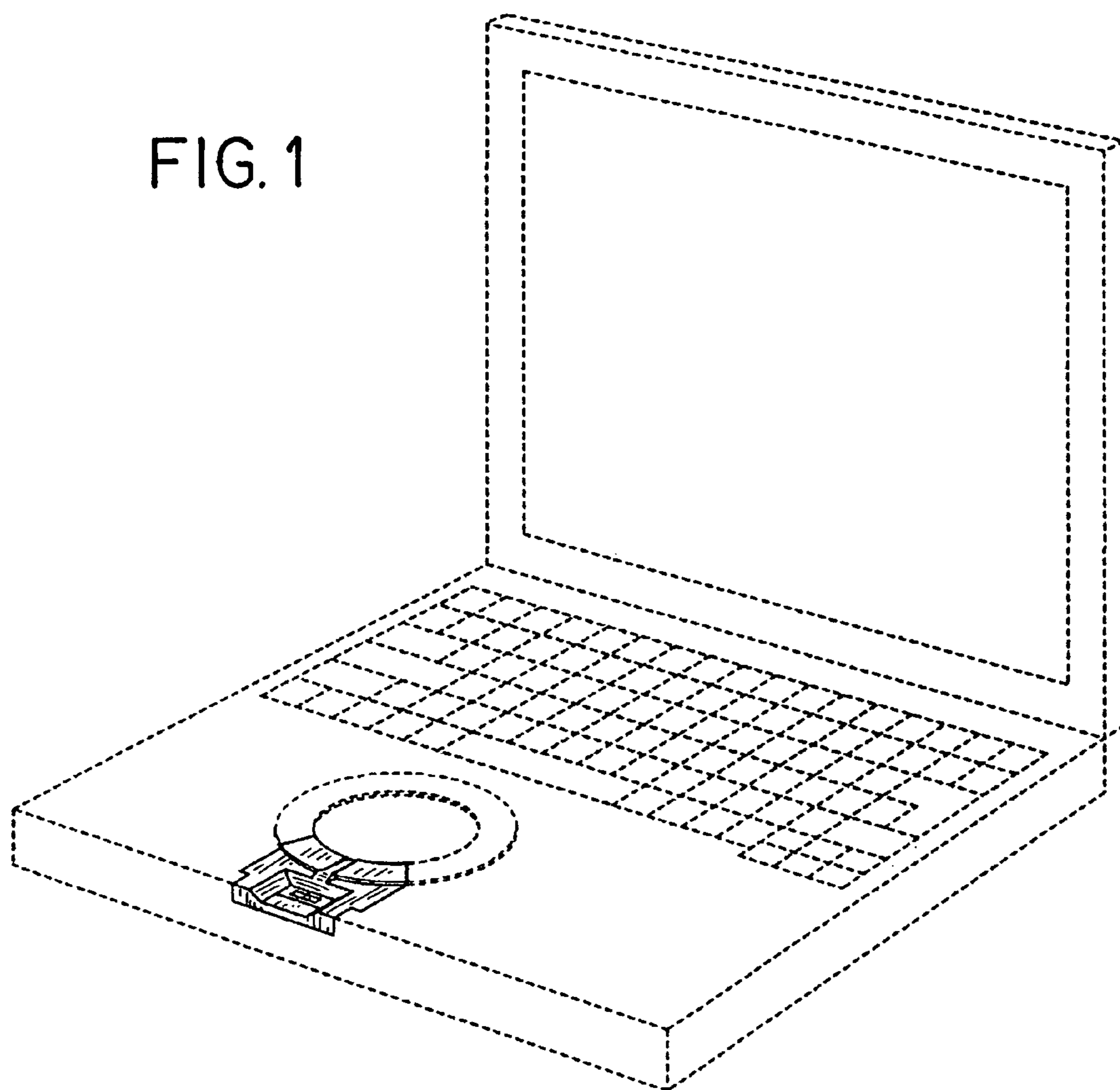

FIG. 2

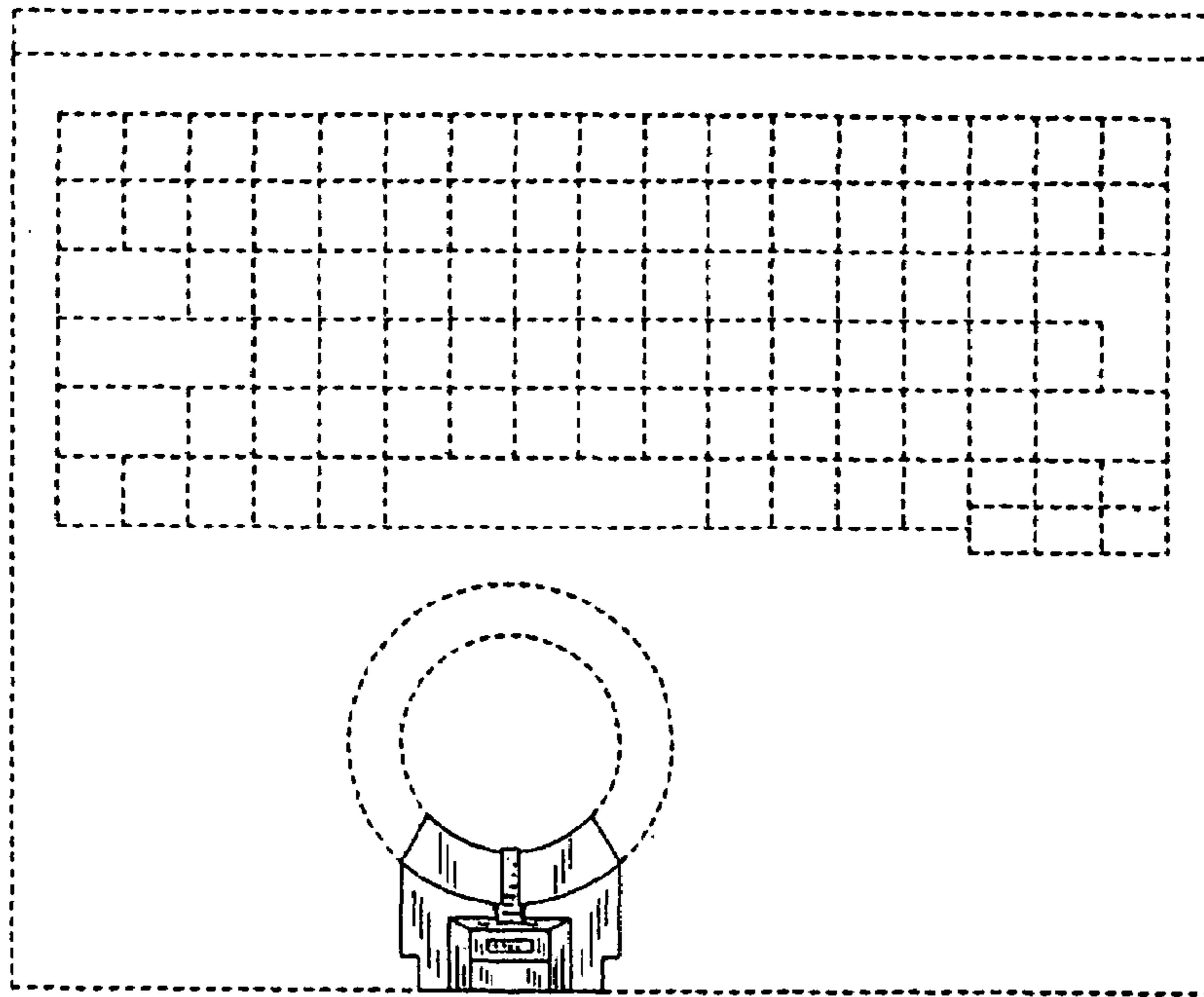

FIG. 3

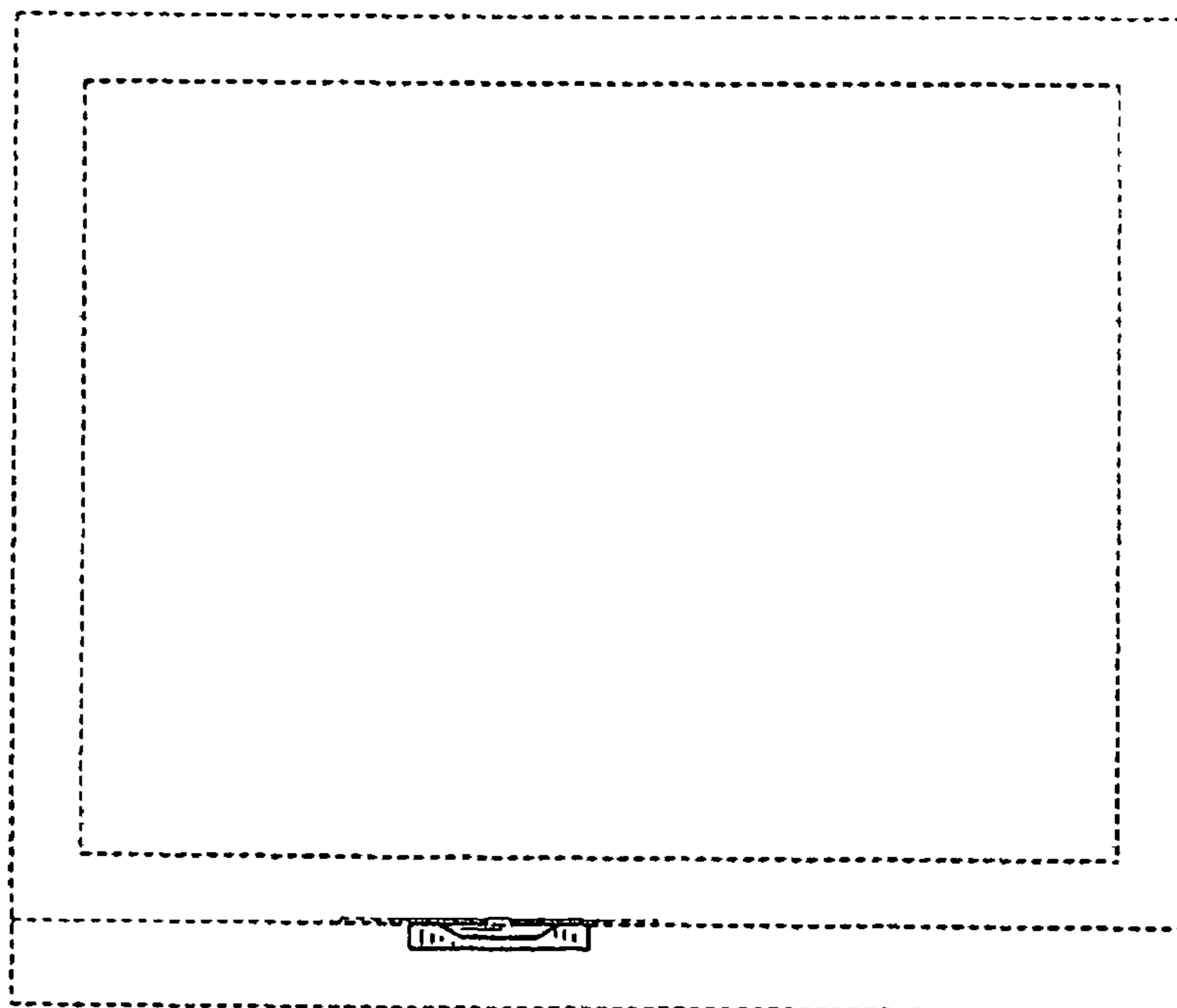

FIG. 4

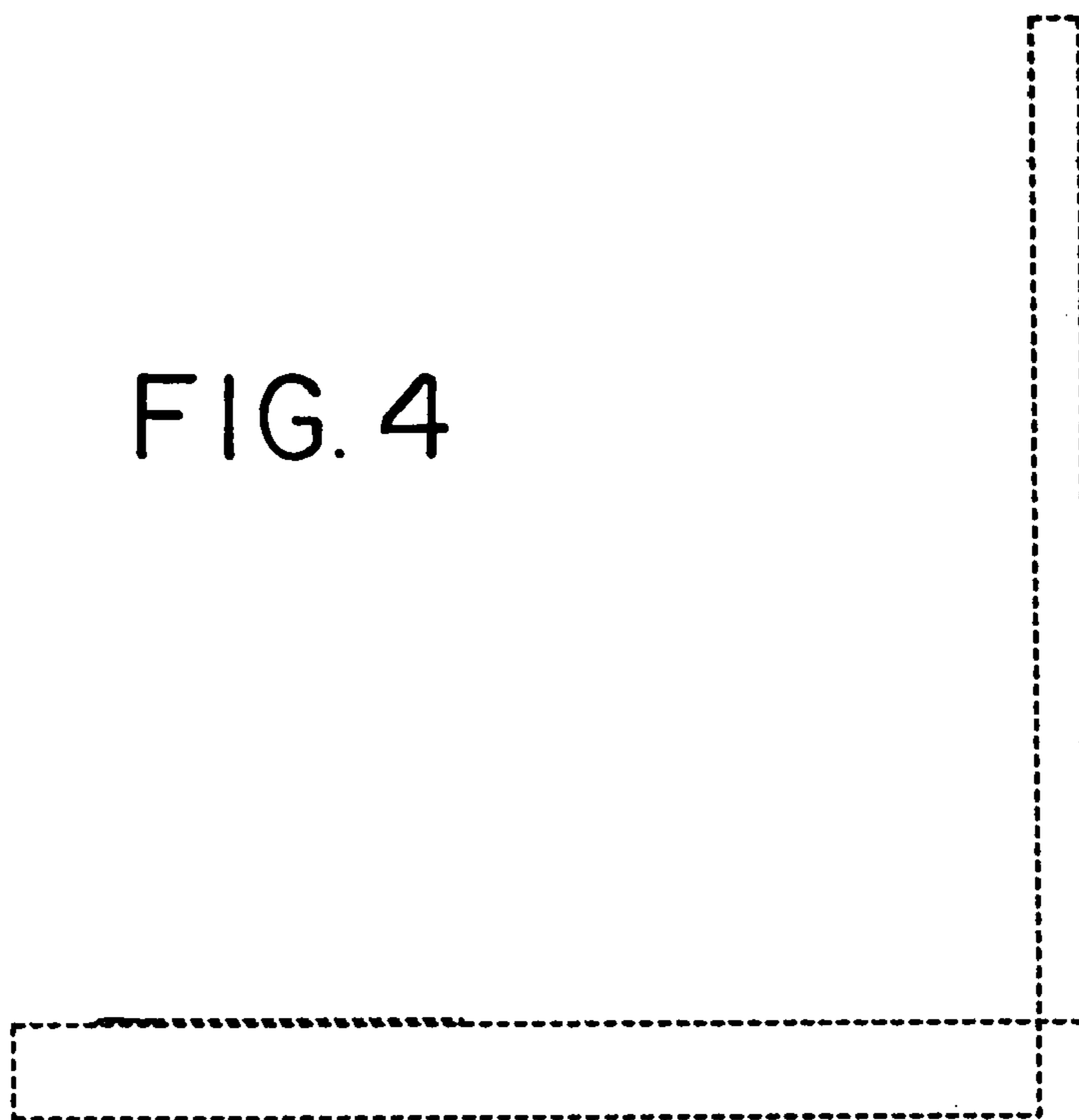

FIG. 5

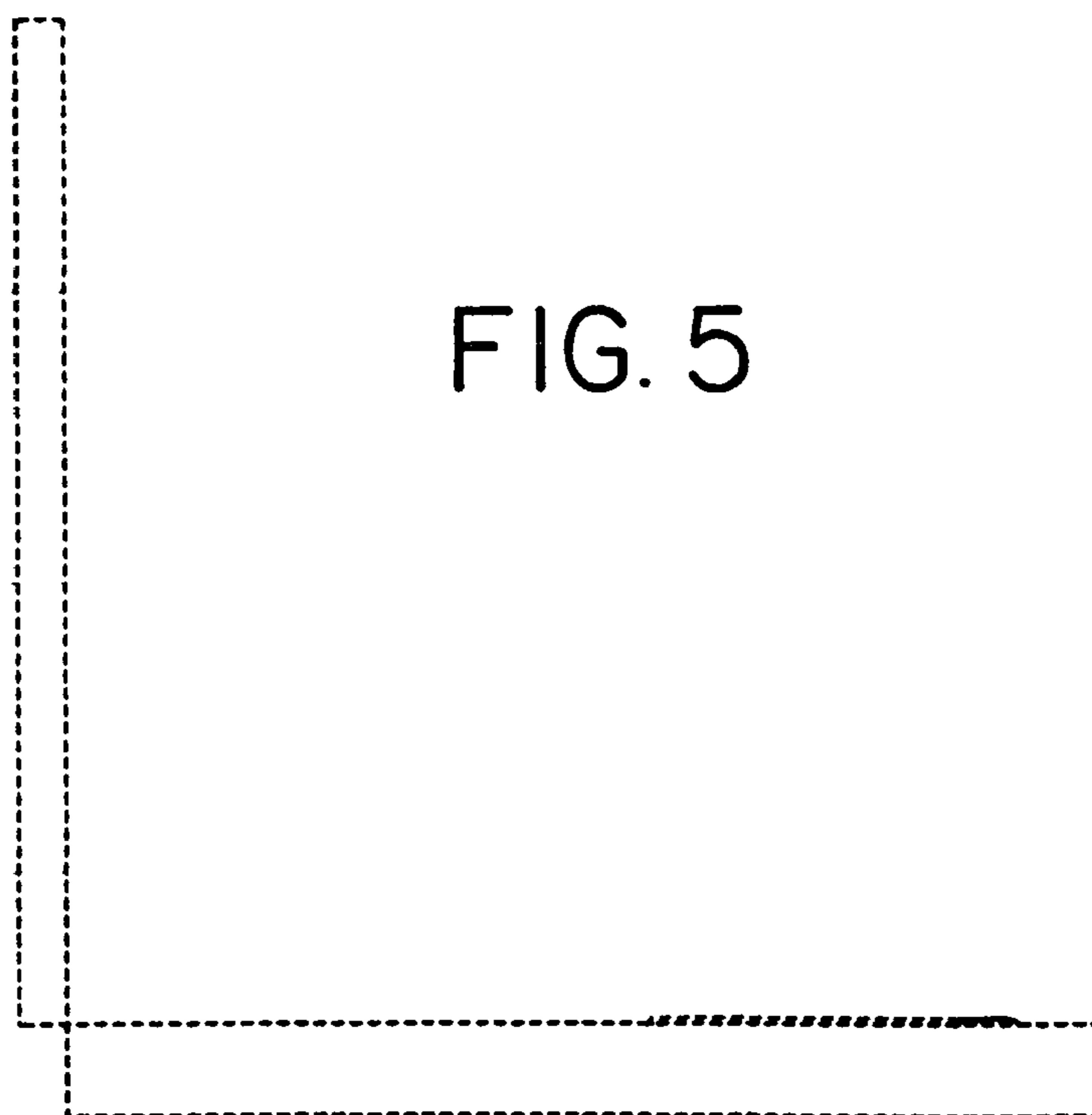



FIG. 6

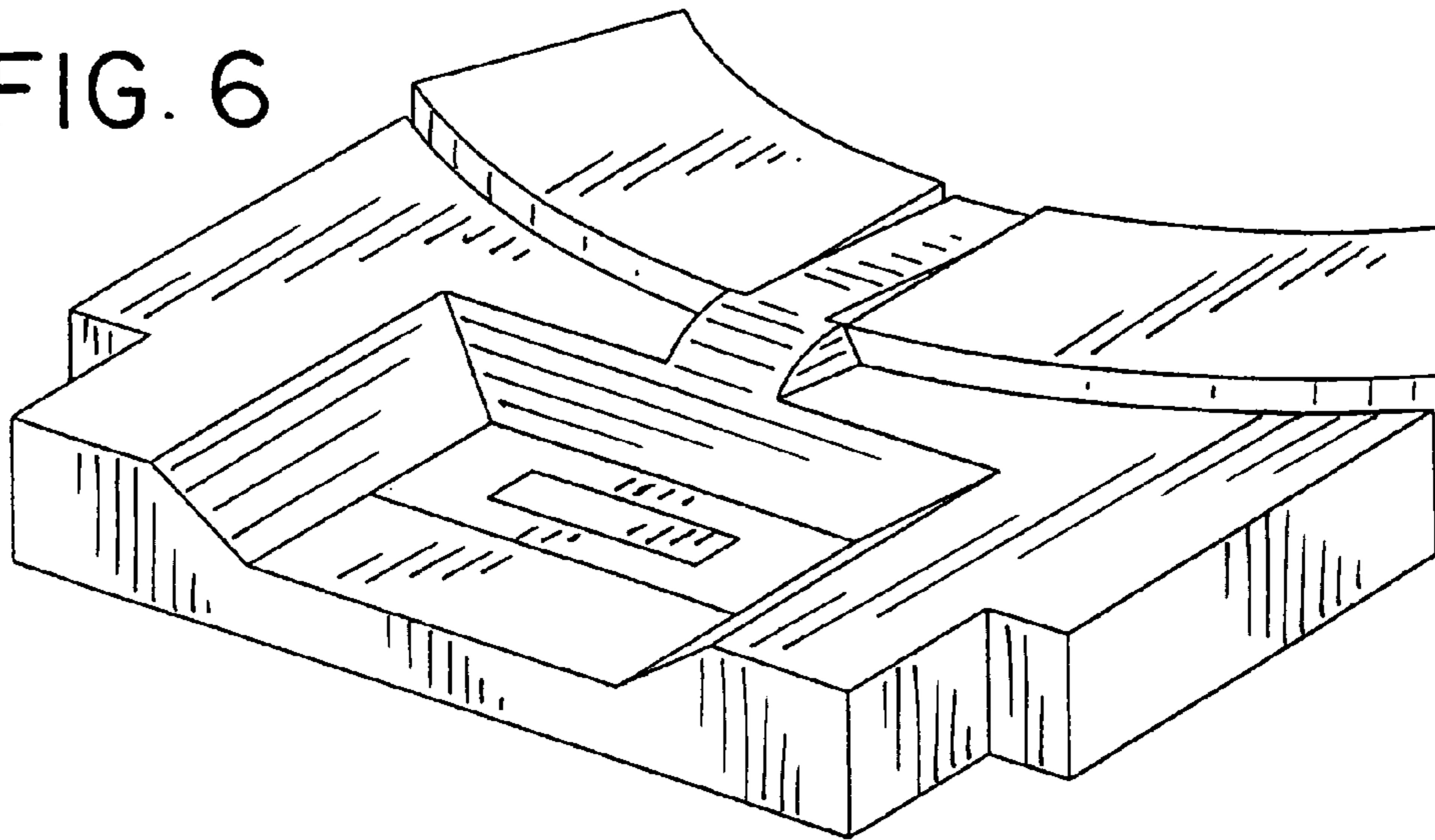

FIG. 7

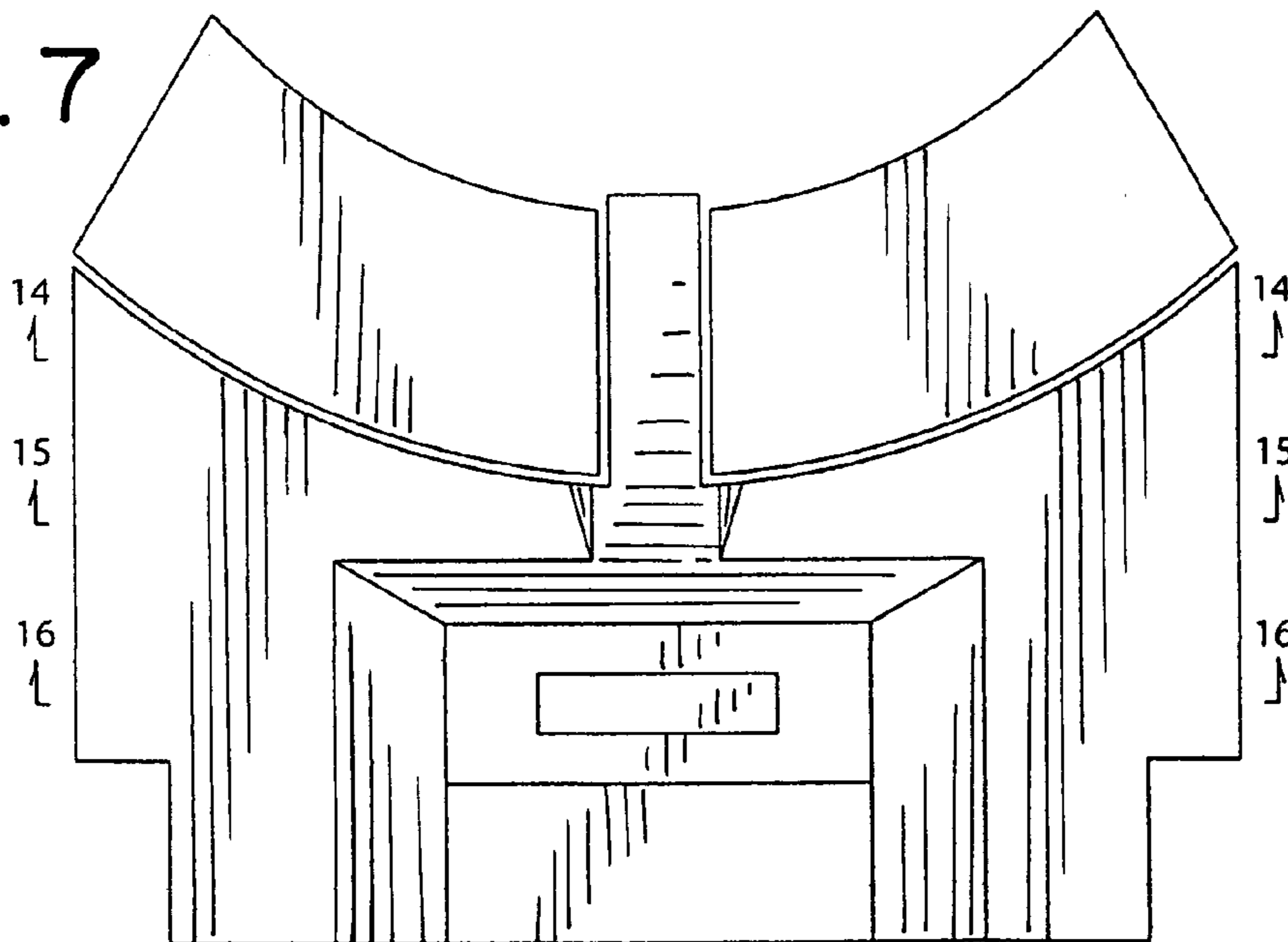

FIG. 8

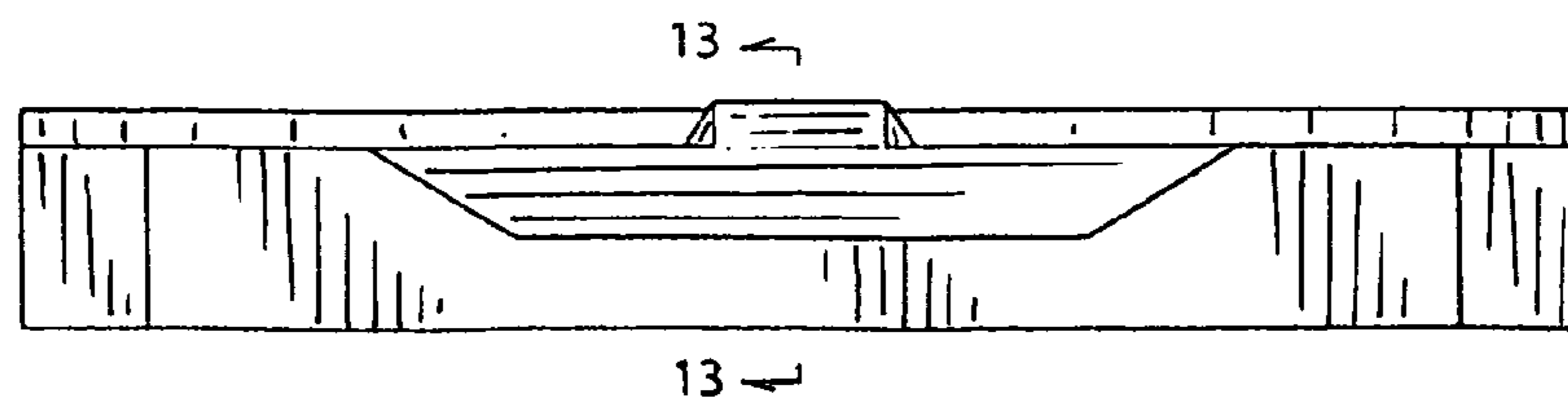

FIG. 9

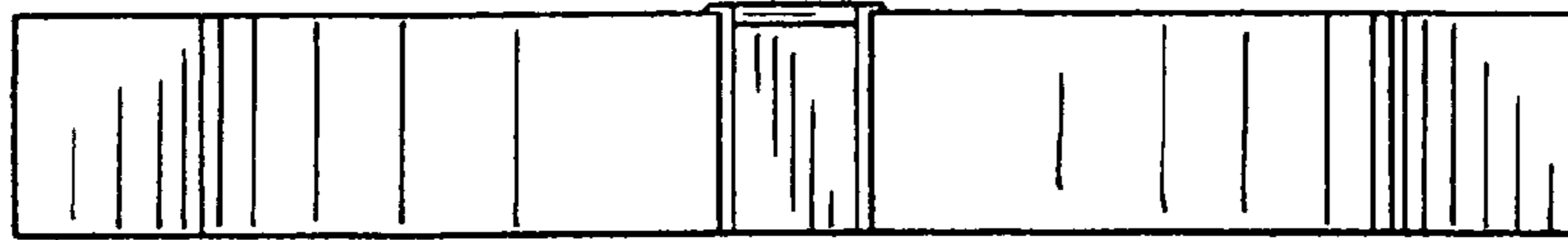

FIG. 10

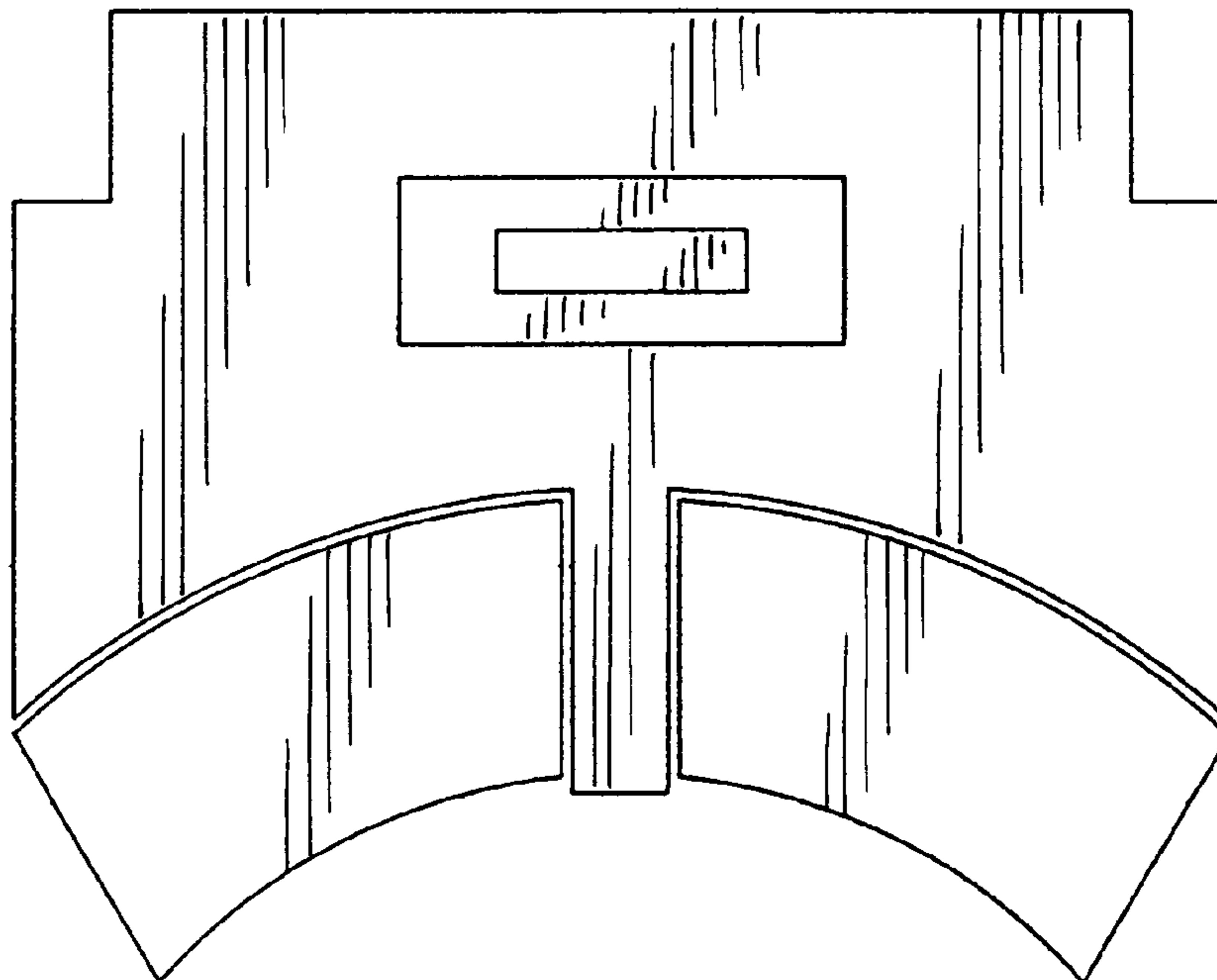

FIG. 11

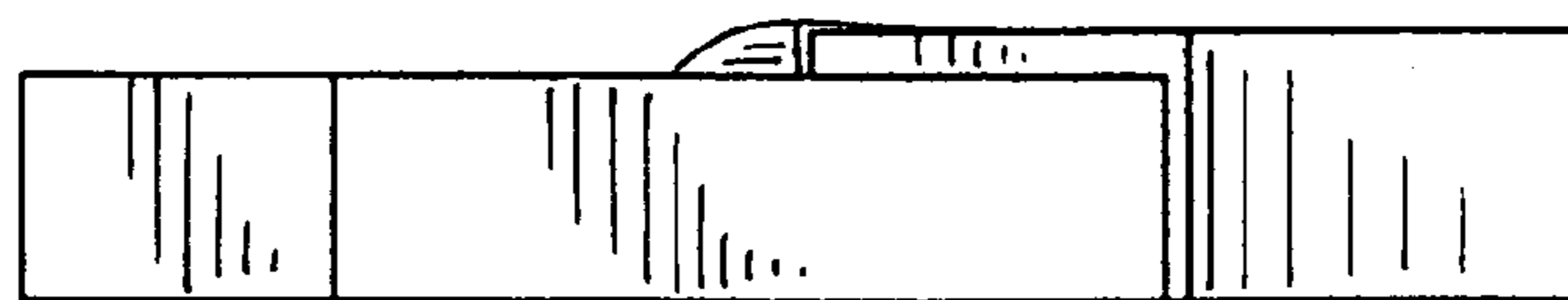

FIG. 12

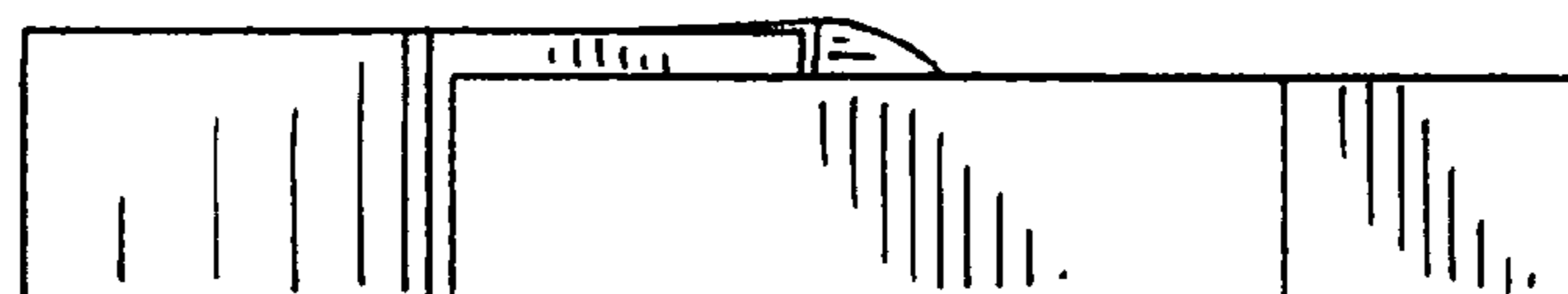

FIG. 13

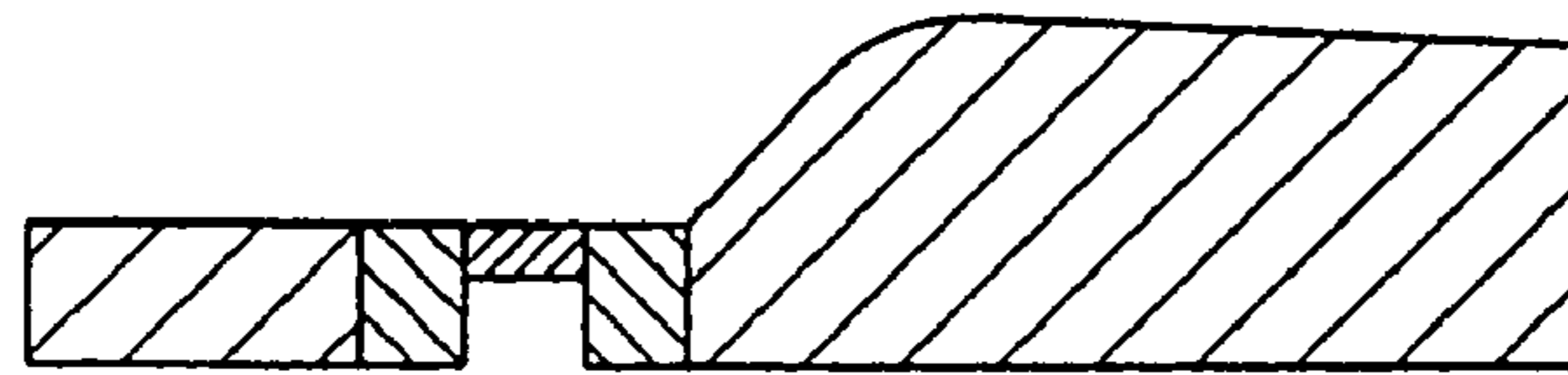

FIG. 14

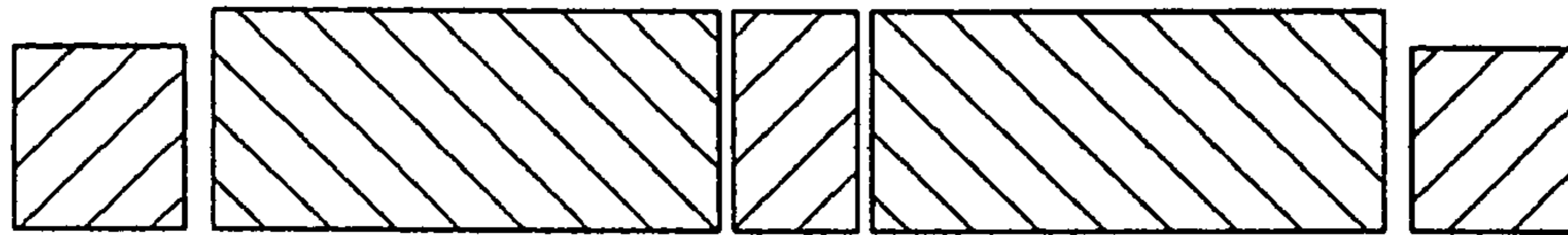

FIG. 15

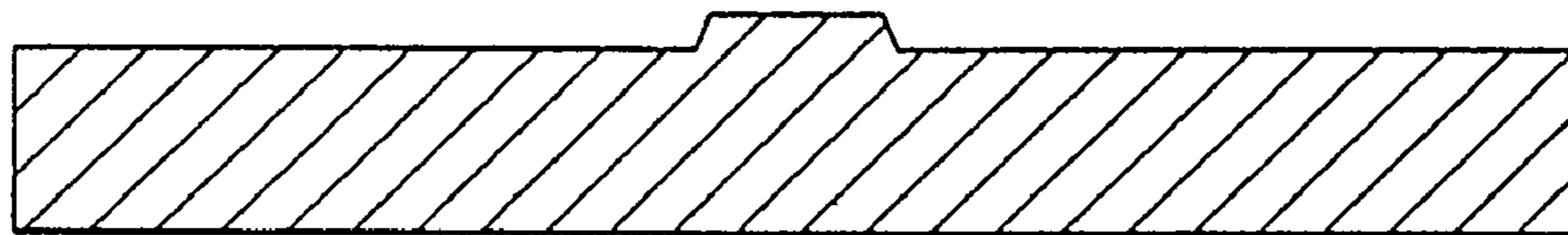

FIG. 16

