



US00D596634S

(12) **United States Design Patent**
Wong et al.

(10) **Patent No.:** **US D596,634 S**
(45) **Date of Patent:** **** Jul. 21, 2009**

(54) **DATA TRANSMISSION DEVICE**

D579,931 S * 11/2008 Chang D14/358

(75) Inventors: **Andrew Wong**, Herrenberg (DE); **Dieter Schwarz**, Voehringen (DE)

D580,422 S * 11/2008 Lee D14/240

D583,367 S * 12/2008 Chen D14/358

(73) Assignee: **British Sky Broadcasting Limited**,
Isleworth, Middlesex (GB)

* cited by examiner

(**) Term: **14 Years**

Primary Examiner—Brian N Vinson

(21) Appl. No.: **29/297,777**

(74) *Attorney, Agent, or Firm*—Townsend and Townsend and Crew LLP

(22) Filed: **Nov. 16, 2007**

(57) **CLAIM**

(30) **Foreign Application Priority Data**

The ornamental design for a data transmission device, as shown and described.

May 18, 2007 (EM) 000728225

(51) **LOC (9) Cl.** **14-02**

(52) **U.S. Cl.** **D14/358**

(58) **Field of Classification Search** D14/356,
D14/358, 432, 433, 137, 138, 140, 155, 188,
D14/217, 240, 299; D13/110, 184; 439/488,
439/490, 901; 379/1.03, 38, 39, 42, 67.1,
379/88.17, 90.01, 93.01, 93.17, 142.07, 219,
379/220.01, 221.14, 221.15, 387.01, 397,
379/399.01, 419, 428.01, 457; 455/3.01,
455/3.05, 3.06, 426.1, 500, 575.1, 89, 91,
455/95, 130, 132, 344, 347, 899

See application file for complete search history.

(56) **References Cited**

U.S. PATENT DOCUMENTS

D573,144 S * 7/2008 Lin D14/358

DESCRIPTION

FIG. 1 is a front perspective view of a data transmission device showing our new design;

FIG. 2 is a front elevation view thereof;

FIG. 3 is a rear elevation view thereof;

FIG. 4 is a top plan view thereof;

FIG. 5 is a side view thereof;

FIG. 6 is a bottom plan view thereof;

FIG. 7 is the other side view thereof; and,

FIG. 8 is a sectional view through FIG. 1 as indicated.

1 Claim, 8 Drawing Sheets

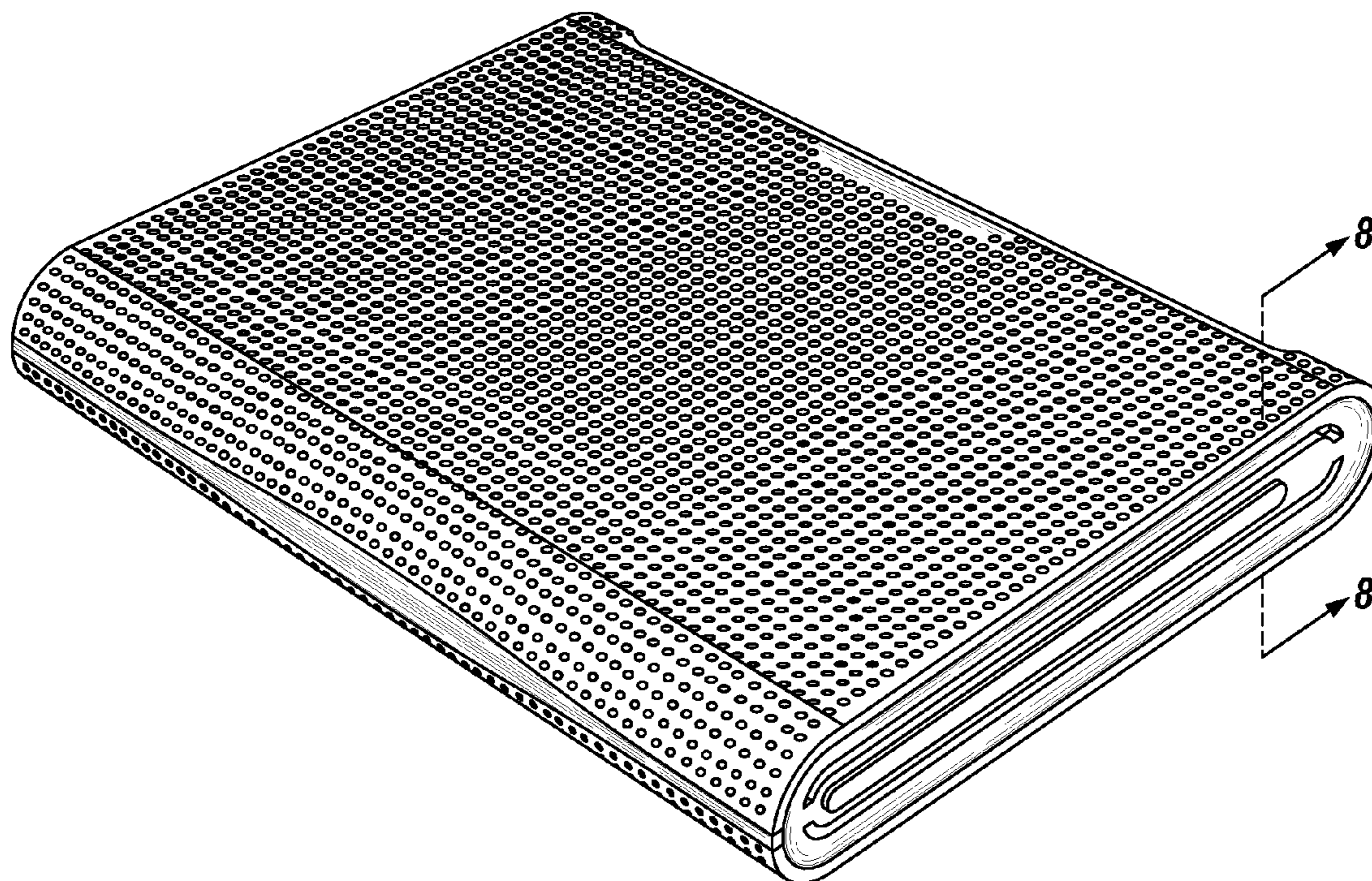

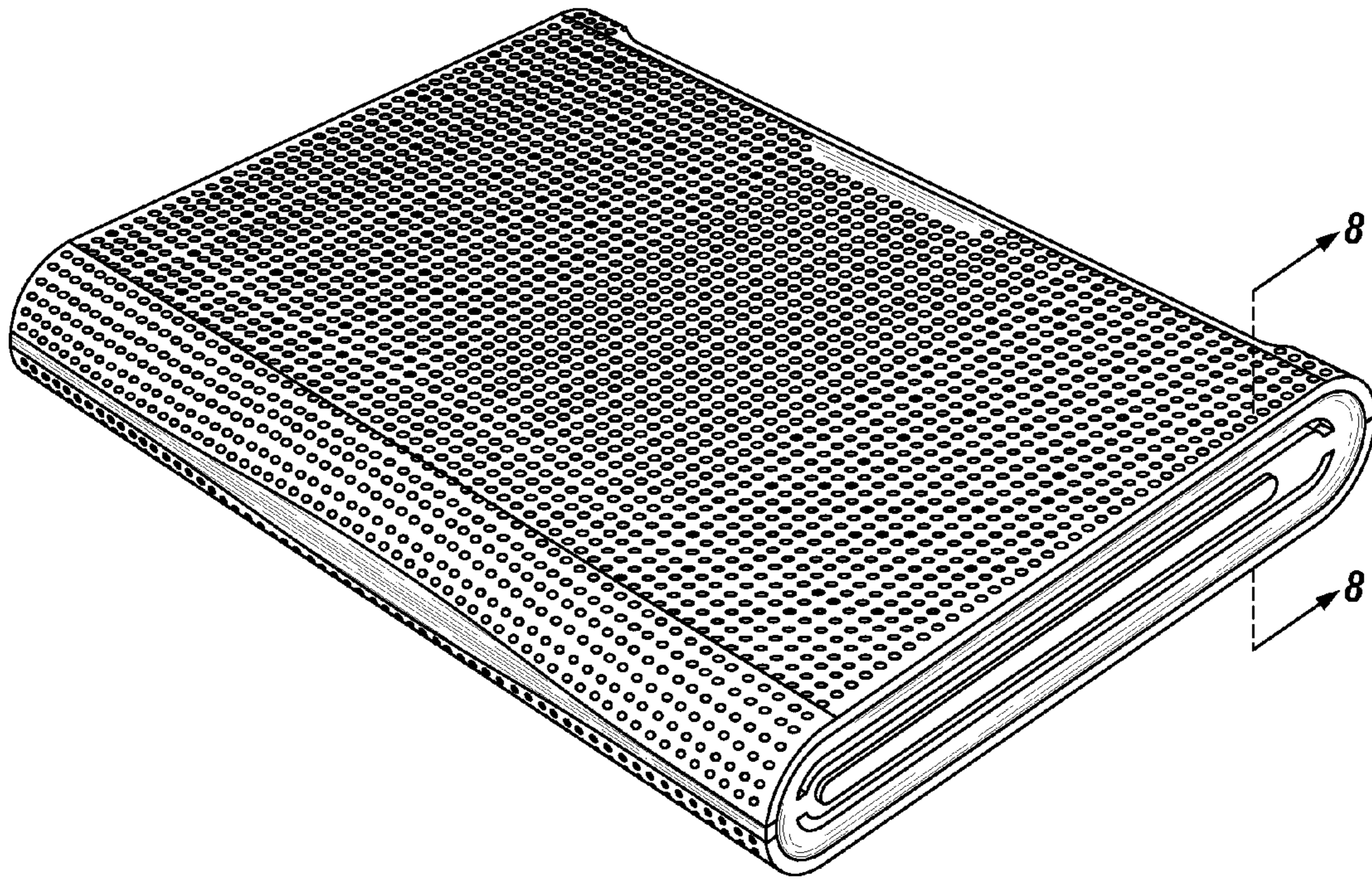

FIG. 1

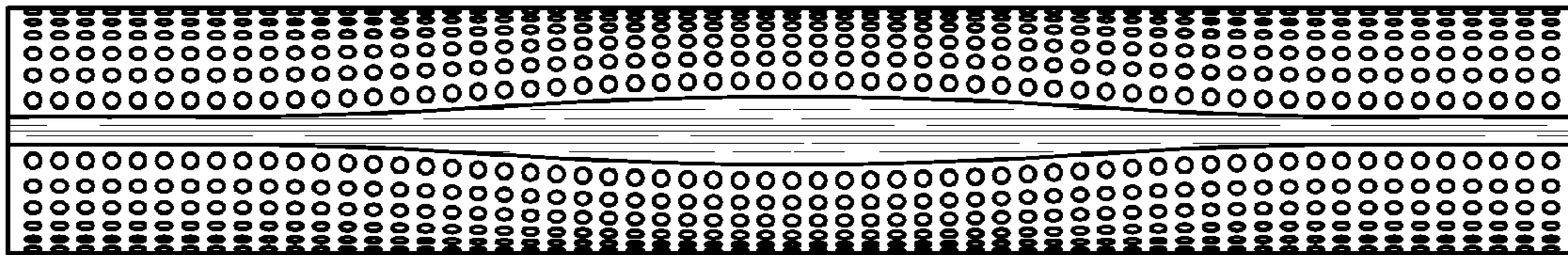

FIG. 2

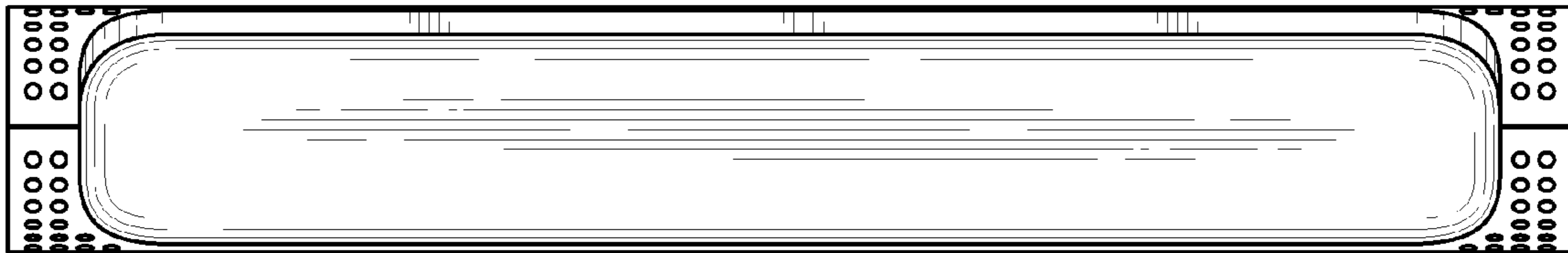

FIG. 3

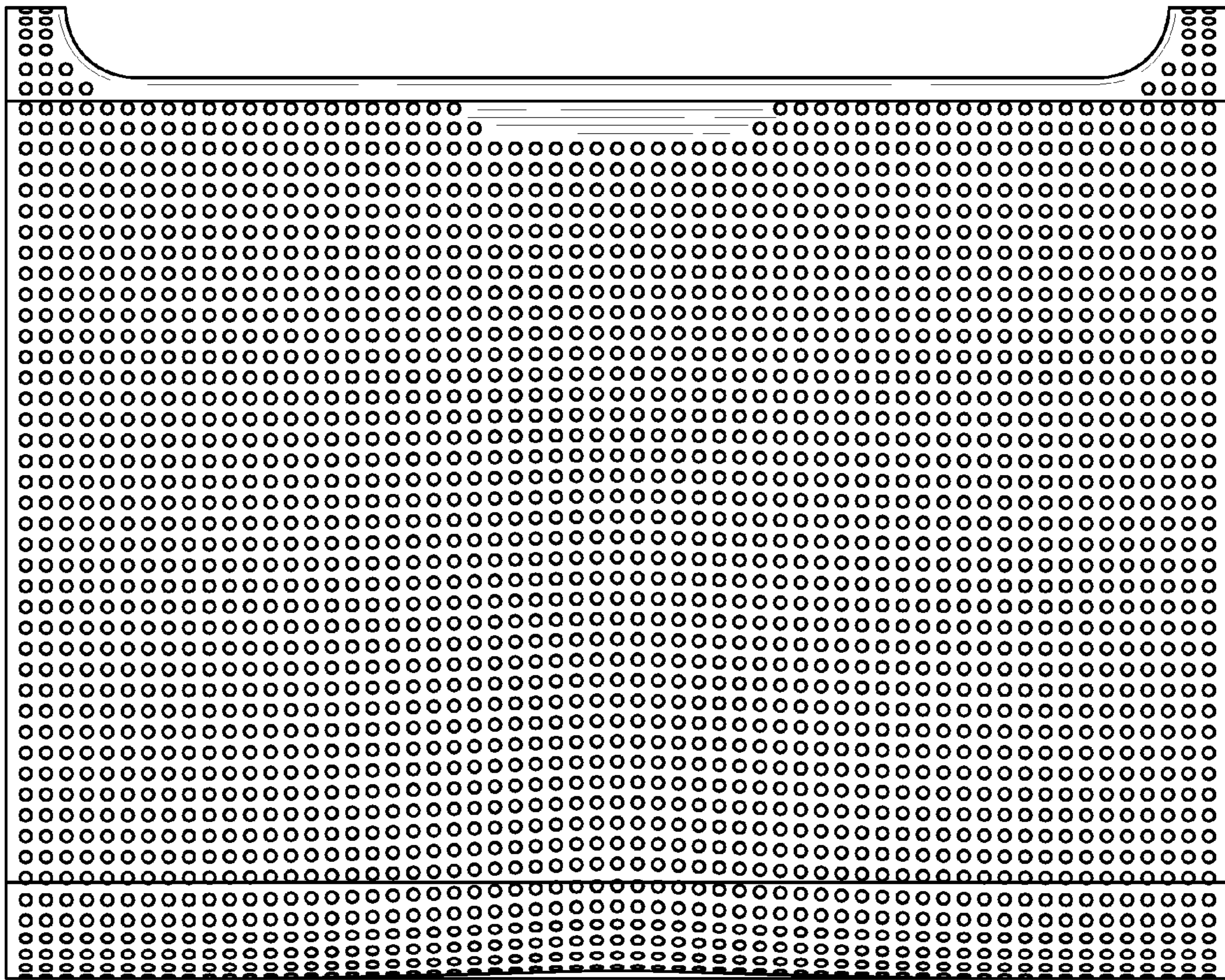

FIG. 4



FIG. 5

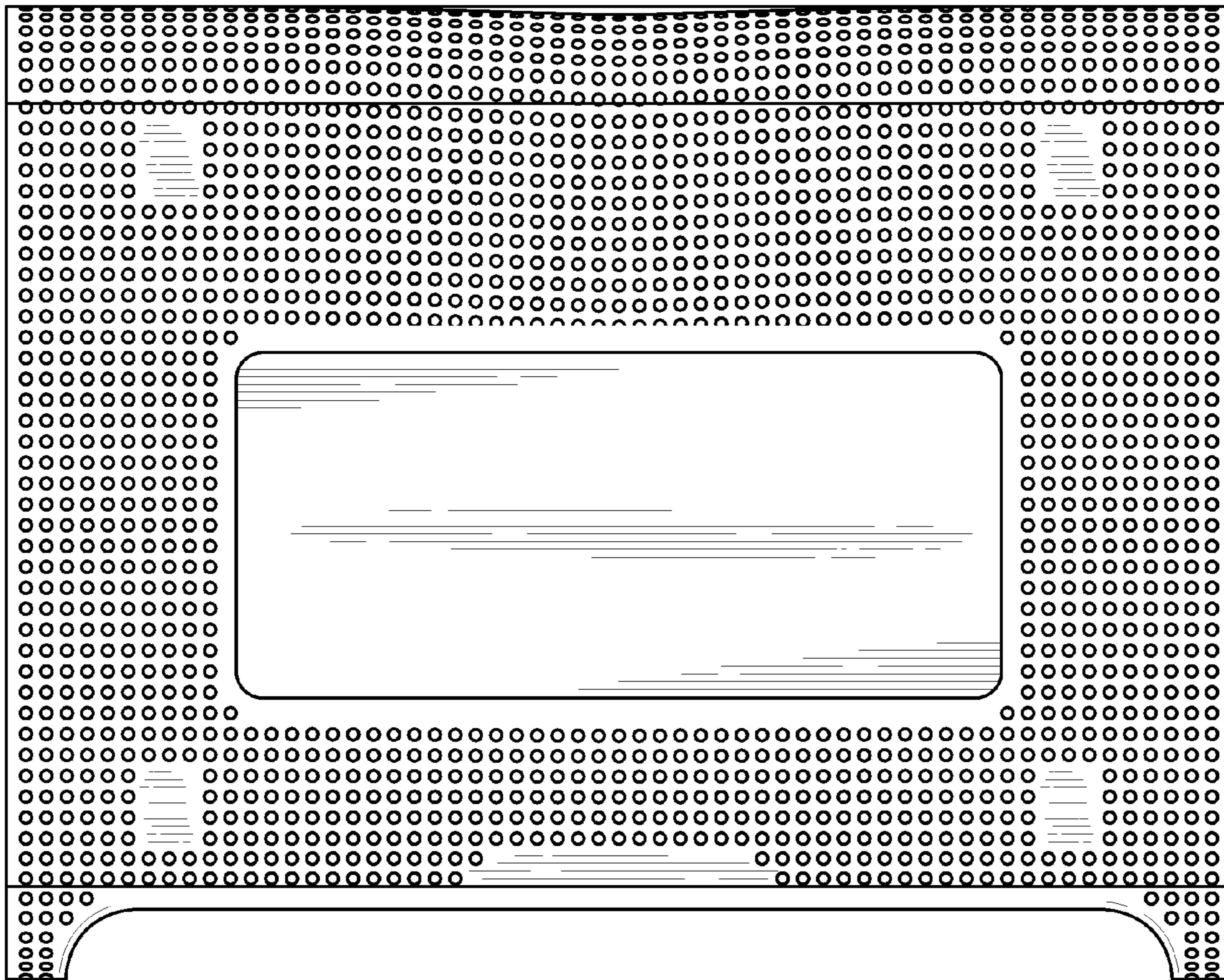

FIG. 6

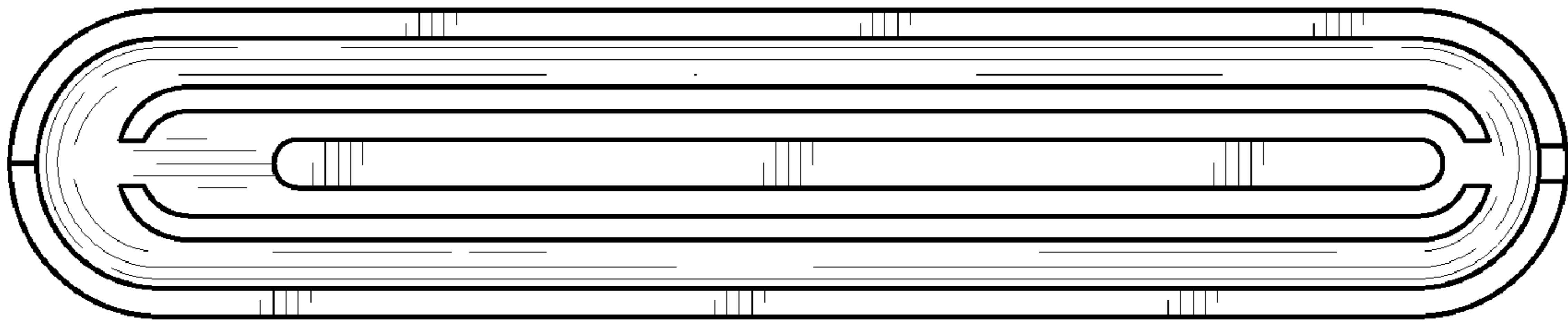

FIG. 7

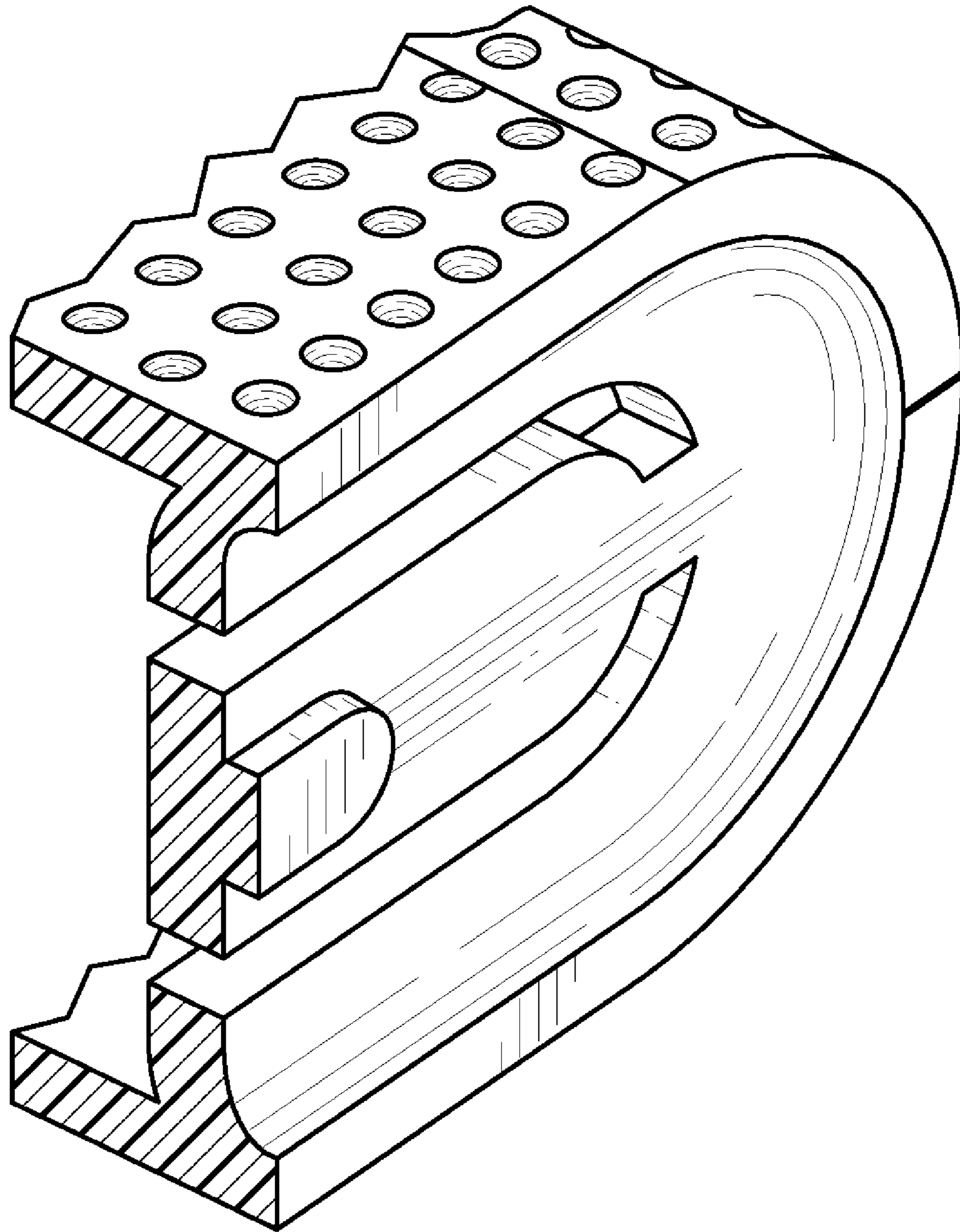

FIG. 8