



US00D596624S

(12) **United States Design Patent**  
**Hong et al.**

(10) **Patent No.:** **US D596,624 S**  
(45) **Date of Patent:** **\*\* Jul. 21, 2009**

(54) **WIRELESS EARPHONE**

(75) Inventors: **Fu-Long Hong**, Taoyuan County (TW);  
**Hsiao-Chuan Huang**, Taoyuan County  
(TW); **Yi-Bin Ho**, Taoyuan County  
(TW); **Meng-Sheng Chiang**, Taoyuan  
County (TW)

(73) Assignee: **HTC Corporation**, Taoyuan County  
(TW)

(\*\*) Term: **14 Years**

(21) Appl. No.: **29/321,871**

(22) Filed: **Jul. 24, 2008**

(30) **Foreign Application Priority Data**

Mar. 31, 2008 (TW) ..... 97301890

(51) **LOC (9) Cl.** ..... **14-01**

(52) **U.S. Cl.** ..... **D14/223**

(58) **Field of Classification Search** ..... D14/205,  
D14/206, 223, 257, 192, 194, 483; 181/129,  
181/130, 135, 149; 379/430, 431, 433.01,  
379/433.02, 433.03, 433.11; 381/313, 328,  
381/151, 173, 322, 370, 380, 381, 360, 369;  
D13/110, 113, 154; 455/575.1, 575.2, 90.3  
See application file for complete search history.

(56) **References Cited**

**U.S. PATENT DOCUMENTS**

6,704,429 B2 \* 3/2004 Lin ..... 381/380  
6,922,476 B2 \* 7/2005 Nassimi ..... 381/380  
7,106,876 B2 \* 9/2006 Santiago ..... 381/369  
D538,792 S \* 3/2007 Kim et al. .... D14/223

D550,658 S \* 9/2007 Wang ..... D14/223  
D555,151 S \* 11/2007 Eklund ..... D14/223  
D559,836 S \* 1/2008 Lee ..... D14/223  
D566,108 S \* 4/2008 Kan ..... D14/223  
D568,301 S \* 5/2008 Kim et al. .... D14/223  
D575,277 S \* 8/2008 Gaarde et al. .... D14/223  
D576,609 S \* 9/2008 Bradford et al. .... D14/223  
D579,923 S \* 11/2008 Andre et al. .... D14/223  
D581,396 S \* 11/2008 Wikel et al. .... D14/206  
D582,897 S \* 12/2008 Christopher et al. .... D14/223  
D582,899 S \* 12/2008 Wai ..... D14/223  
D584,285 S \* 1/2009 Xu et al. .... D14/206

\* cited by examiner

*Primary Examiner*—Paula Greene

(74) *Attorney, Agent, or Firm*—Jianq Chyun IP Office

(57) **CLAIM**

The ornamental design for a wireless earphone, as shown and described.

**DESCRIPTION**

FIG. 1 is a perspective view of a wireless earphone showing our new design;

FIG. 2 is a front view thereof;

FIG. 3 is a rear view thereof;

FIG. 4 is a left side view thereof;

FIG. 5 is a right side view thereof;

FIG. 6 is a top view thereof; and,

FIG. 7 is a bottom view thereof.

The broken lines shown in the figures are for illustrative purposes only and do not form part of the claimed design.

**1 Claim, 6 Drawing Sheets**

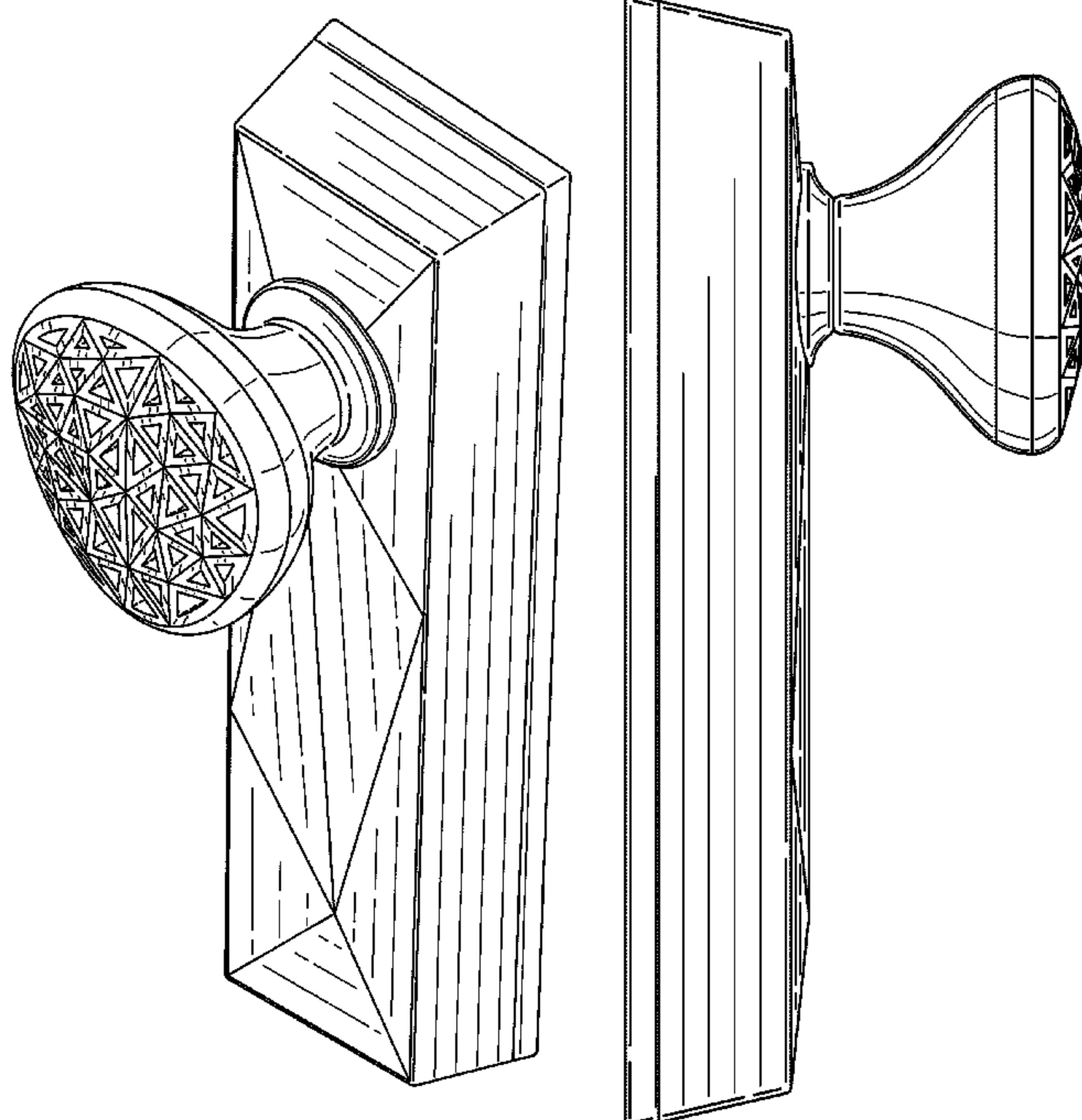

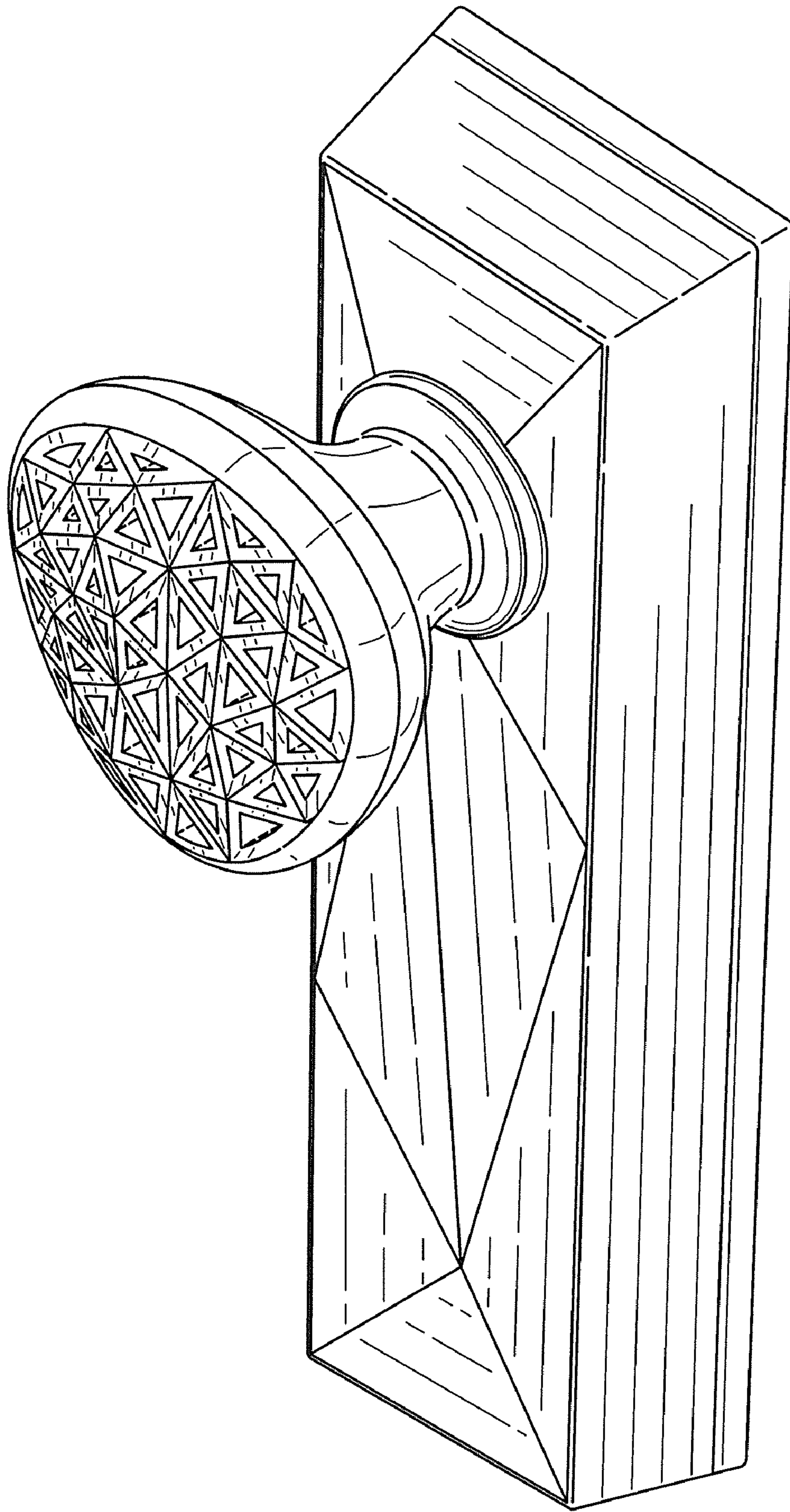

FIG. 1

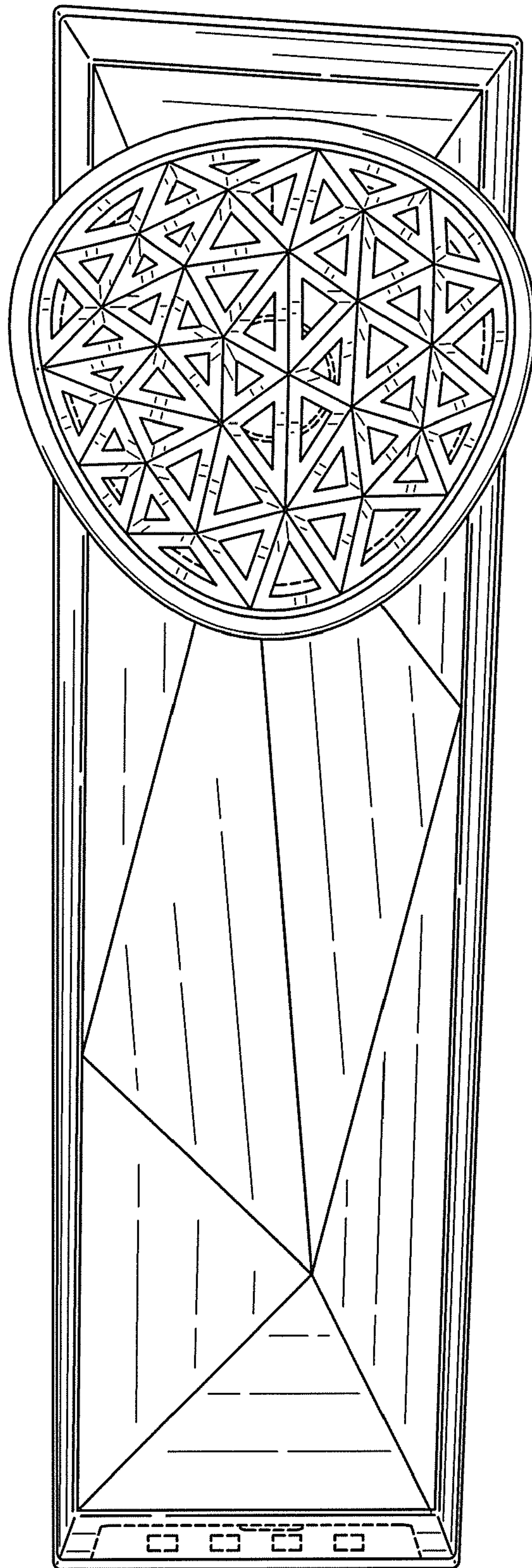

FIG. 2



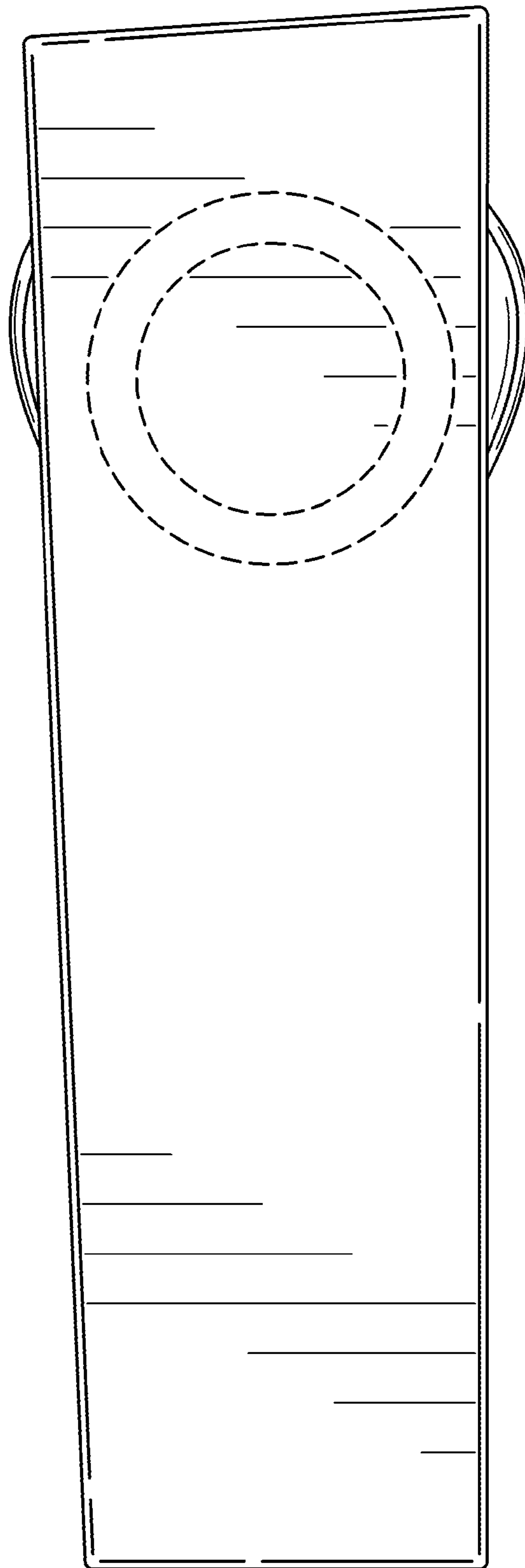

FIG. 3

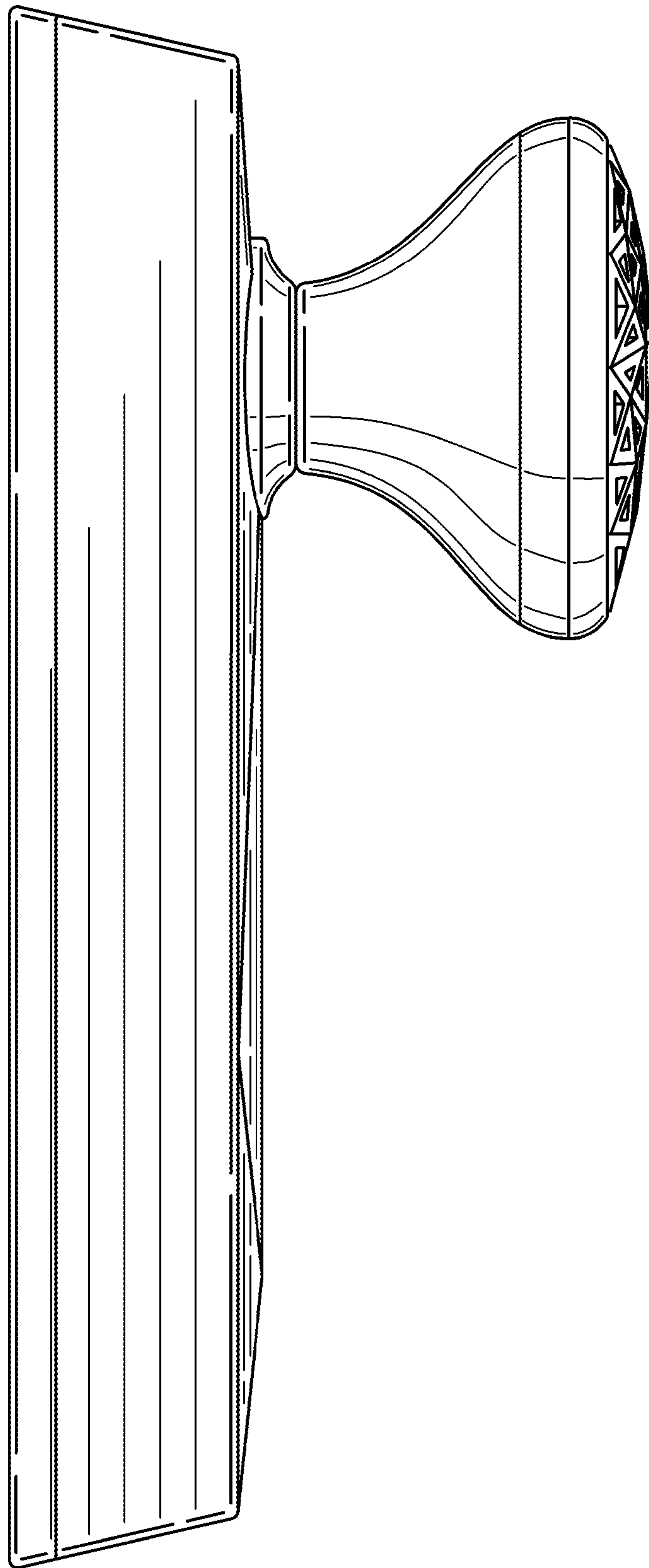

FIG. 4

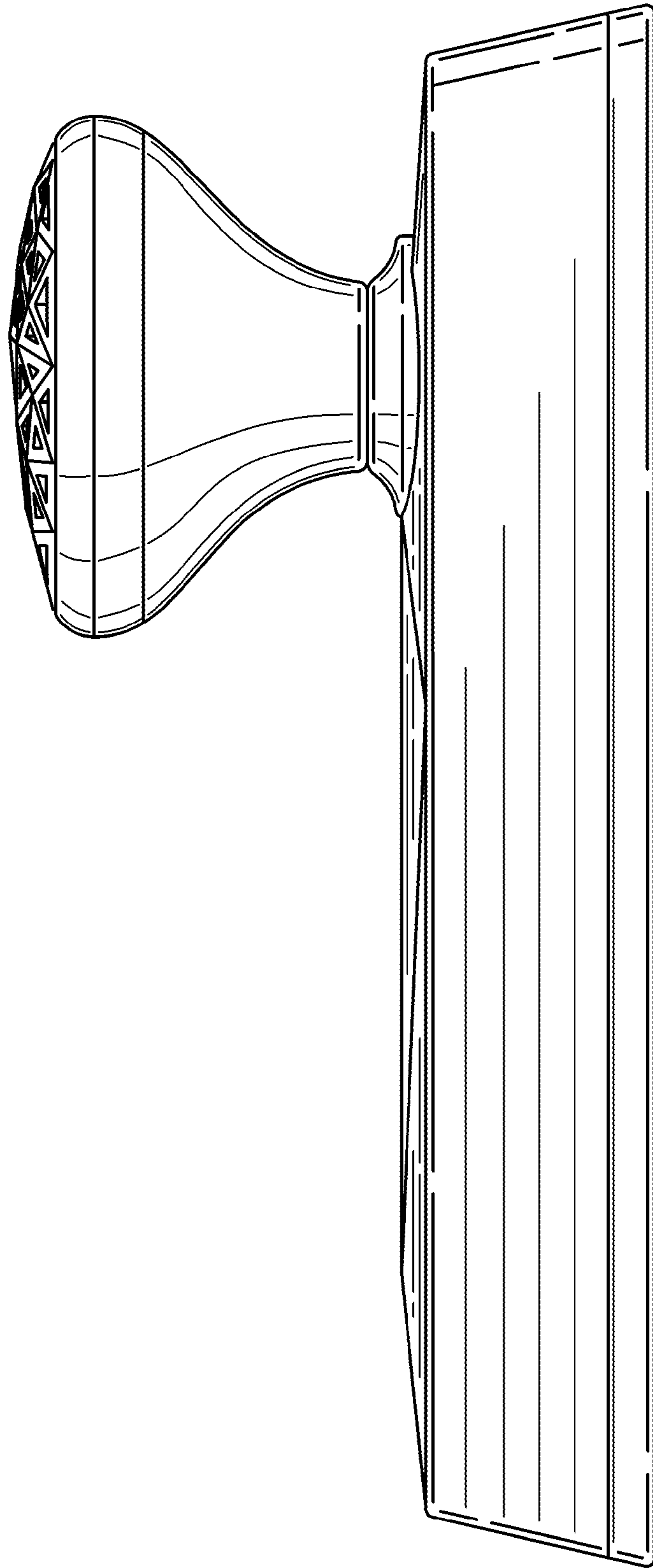

FIG. 5

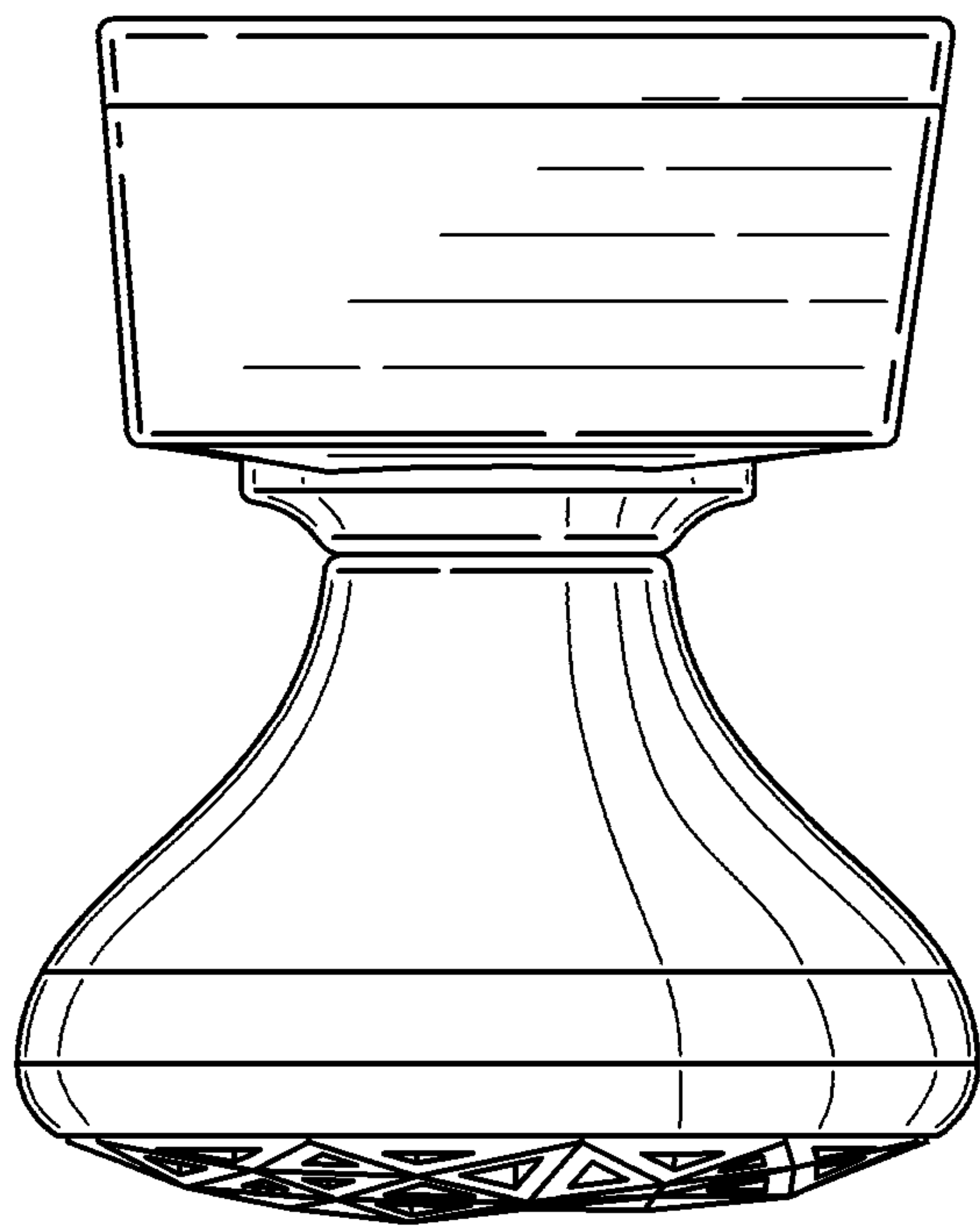

FIG. 6

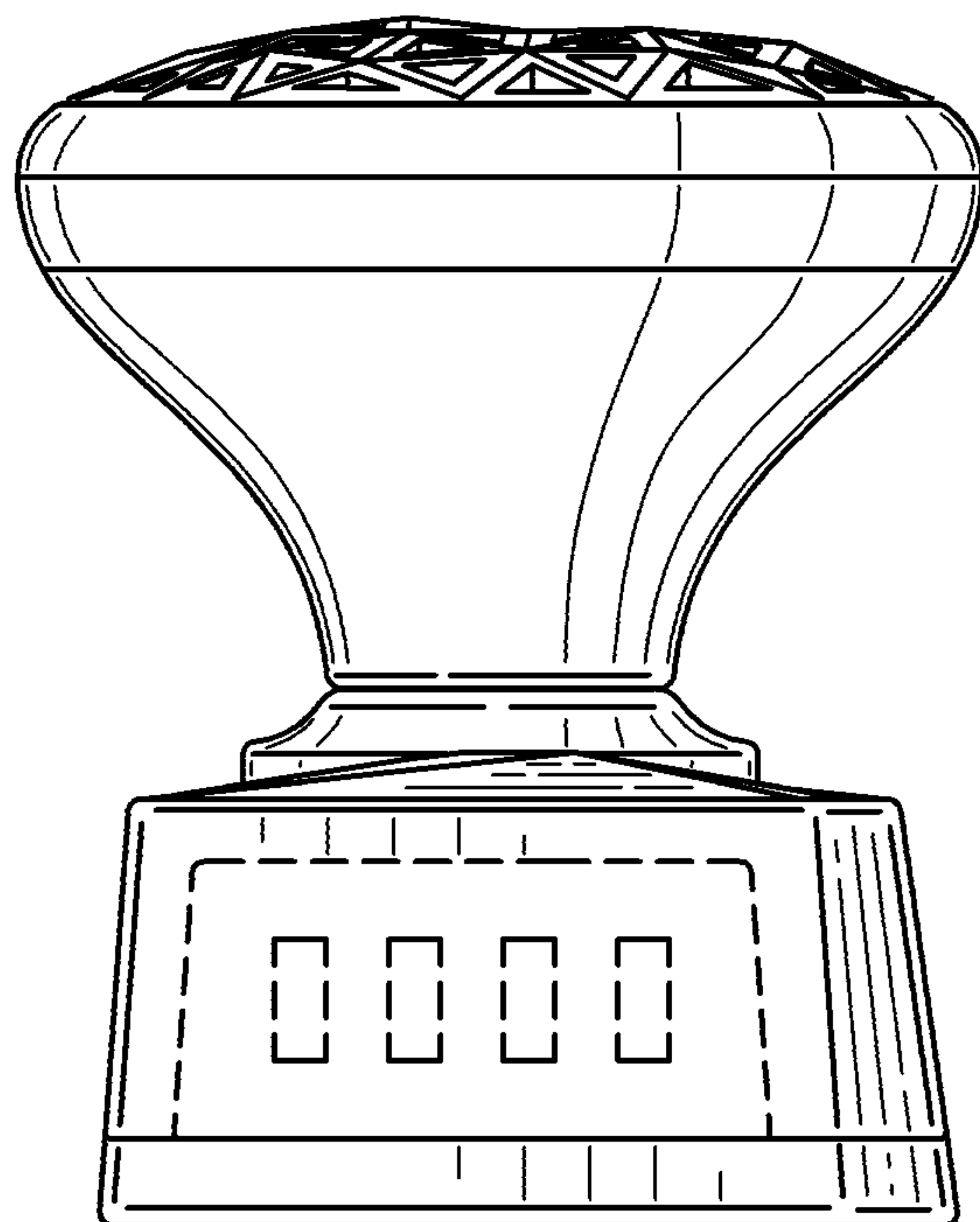

FIG. 7