



US00D596565S

(12) **United States Design Patent**  
**Yasumoto et al.**

(10) **Patent No.:** **US D596,565 S**  
(45) **Date of Patent:** **\*\* Jul. 21, 2009**

(54) **SEPARATOR FOR FUEL CELL**

5,045,413 A 9/1991 Marianowski  
5,108,849 A 4/1992 Watkins

(75) Inventors: **Eiichi Yasumoto**, Kyoto (JP); **Hiroki Kusakabe**, Osaka (JP); **Hideo Ohara**, Osaka (JP)

(Continued)

**FOREIGN PATENT DOCUMENTS**

(73) Assignee: **Panasonic Corporation**, Kadoma-shi (JP)

JP 9-134734 A 5/1997  
JP 2000-48849 A 2/2000

(\*\*) Term: **14 Years**

*Primary Examiner*—Prabhakar Deshmukh  
*Assistant Examiner*—Derrick Holland

(21) Appl. No.: **29/328,247**

(74) *Attorney, Agent, or Firm*—Christensen O'Connor Johnson Kindness PLLC

(22) Filed: **Nov. 20, 2008**

(57) **CLAIM**

**Related U.S. Application Data**

The ornamental design for a separator for fuel cell, as shown and described.

(62) Division of application No. 29/217,510, filed on Nov. 17, 2004, now Pat. No. Des. 586,746.

**DESCRIPTION**

(30) **Foreign Application Priority Data**

Jan. 7, 2004 (JP) ..... 2004-019828  
Jan. 7, 2004 (JP) ..... 2004-019829  
Jan. 7, 2004 (JP) ..... 2004-019830  
Jan. 7, 2004 (JP) ..... 2004-019831

FIG. 1 is a perspective view of the top, front, and left side of a separator for fuel cell showing our new design;

FIG. 2 is a front view thereof;

FIG. 3 is a rear view thereof;

FIG. 4 is a left side view thereof;

FIG. 5 is a right side view thereof;

FIG. 6 is a top plan view thereof;

FIG. 7 is a bottom view thereof;

FIG. 8 is a partially enlarged view of the upper end portion of the left side view thereof;

FIG. 9 is a partially enlarged view of the lower end portion of the left side view thereof;

FIG. 10 is a partially enlarged view of the left end portion of the top plan view thereof; and,

FIG. 11 is a partially enlarged view of the left end portion of the bottom view thereof.

The portions of the article in broken lines are shown for illustrative purposes only and form no part of the claimed design.

(51) **LOC (9) Cl.** ..... **13-01**

(52) **U.S. Cl.** ..... **D13/122**

(58) **Field of Classification Search** ..... D13/122, D13/101, 103, 118, 199; D25/102, 113, D25/118, 136, 137; 52/287.1, 288.1; 204/242, 204/254, 257; 429/14, 16, 19, 34-39, 99, 429/100; 439/215, 216  
See application file for complete search history.

(56) **References Cited**

**U.S. PATENT DOCUMENTS**

3,121,525 A 2/1964 Hayes  
3,262,083 A \* 7/1966 Gooding ..... 439/216  
4,002,493 A 1/1977 Warszawski  
4,109,434 A \* 8/1978 Katzin ..... 52/288.1  
4,214,969 A 7/1980 Lawrance  
4,895,774 A \* 1/1990 Ohzu et al. .... 429/35

**1 Claim, 6 Drawing Sheets**

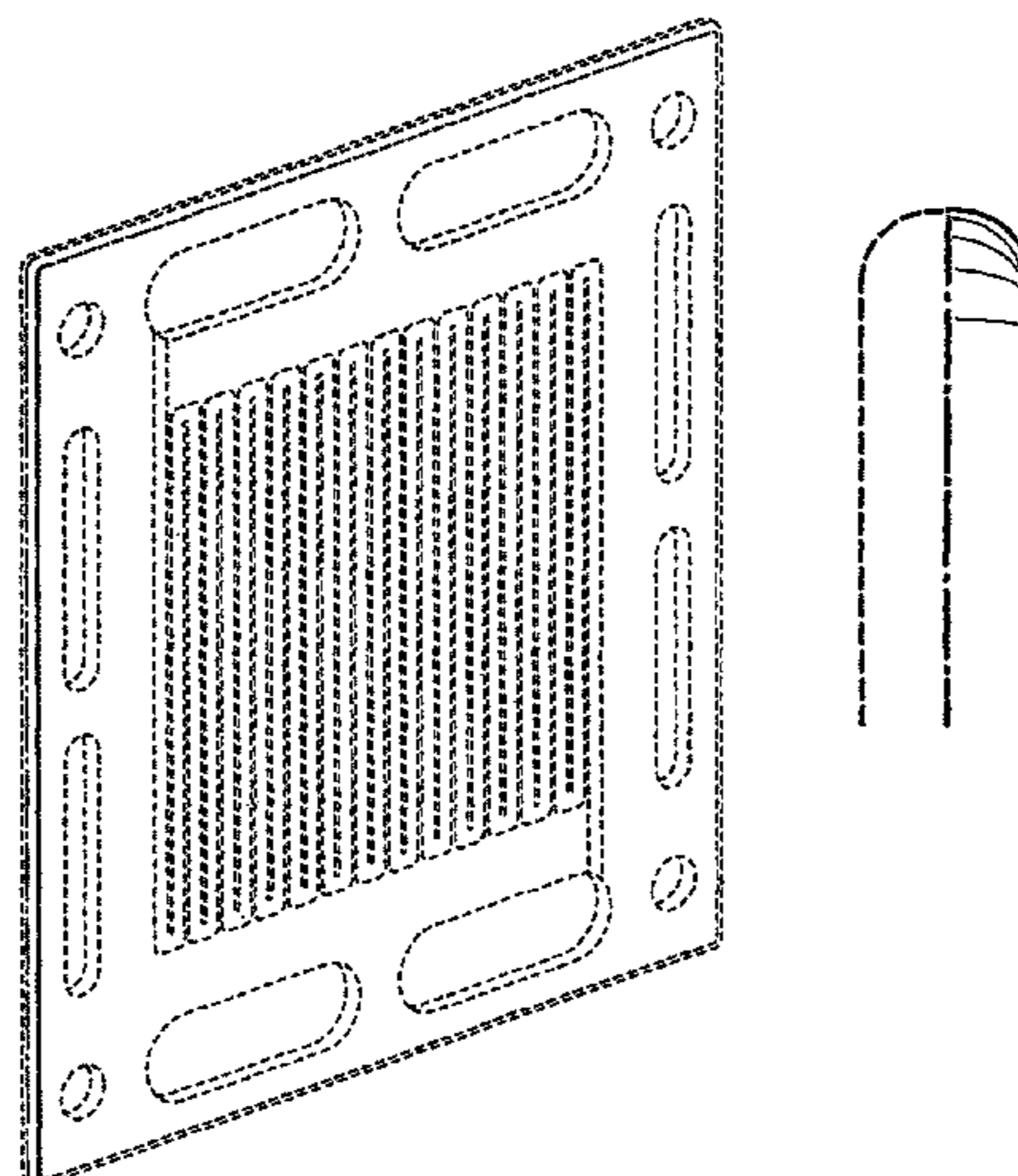

# US D596,565 S

Page 2

---

## U.S. PATENT DOCUMENTS

D367,717 S	3/1996	Prins		D438,988 S	3/2001	Dean, Jr.	
D373,203 S *	8/1996	Kornfalt et al. ....	D25/136	6,216,406 B1 *	4/2001	Hauser .....	52/287.1
5,563,003 A *	10/1996	Suzuki et al. ....	429/14	D453,880 S	2/2002	Cheyne	
5,776,624 A	7/1998	Neutzler		D454,215 S *	3/2002	Nelson et al. ....	D25/136
D414,976 S	10/1999	Su		6,379,795 B1	4/2002	Bisaria	
D431,524 S	10/2000	Sugita		6,403,249 B1	6/2002	Reid	
D432,495 S	10/2000	Sugita		6,607,857 B2 *	8/2003	Blunk et al. ....	429/34

\* cited by examiner

FIG. 1

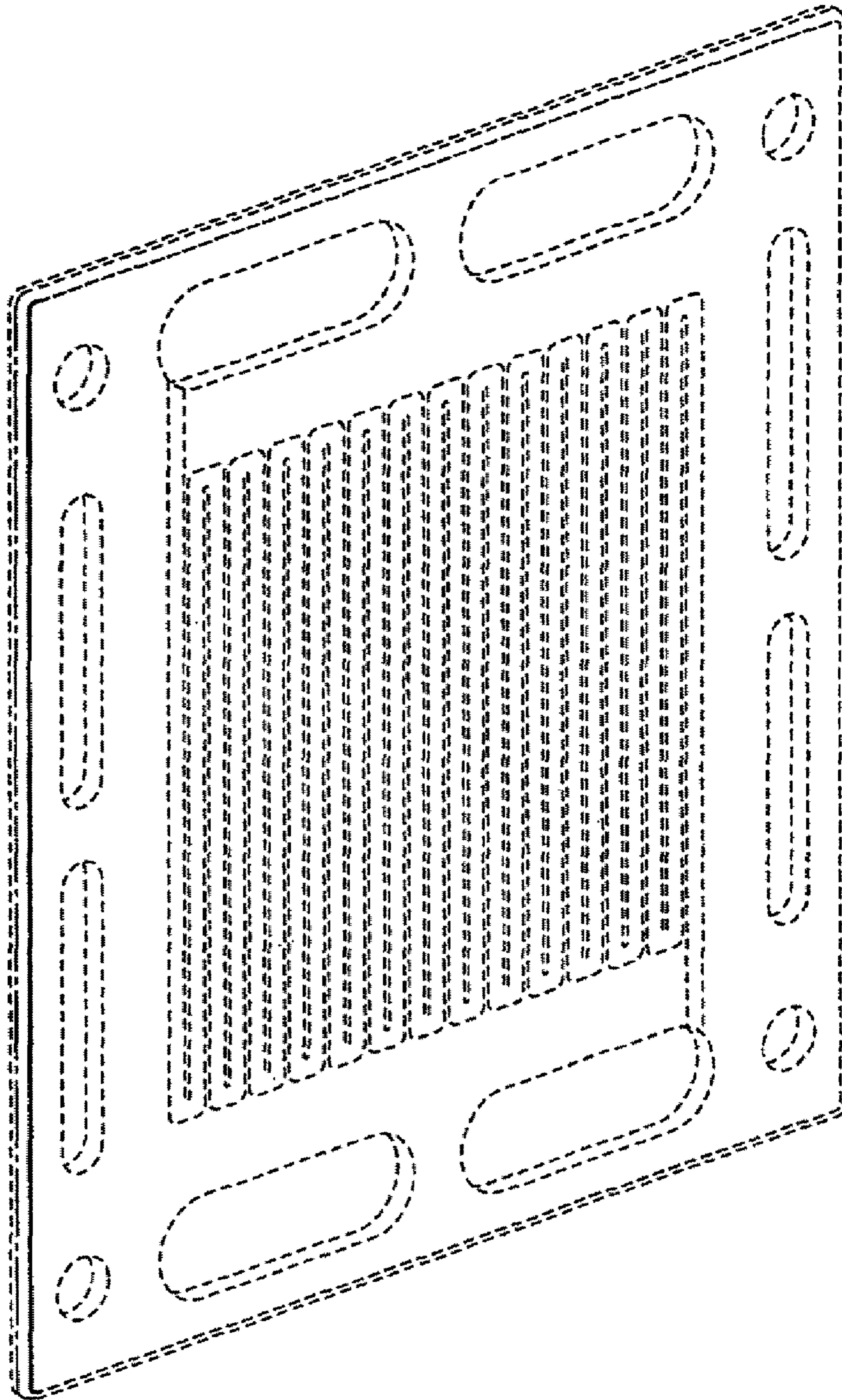

FIG. 2

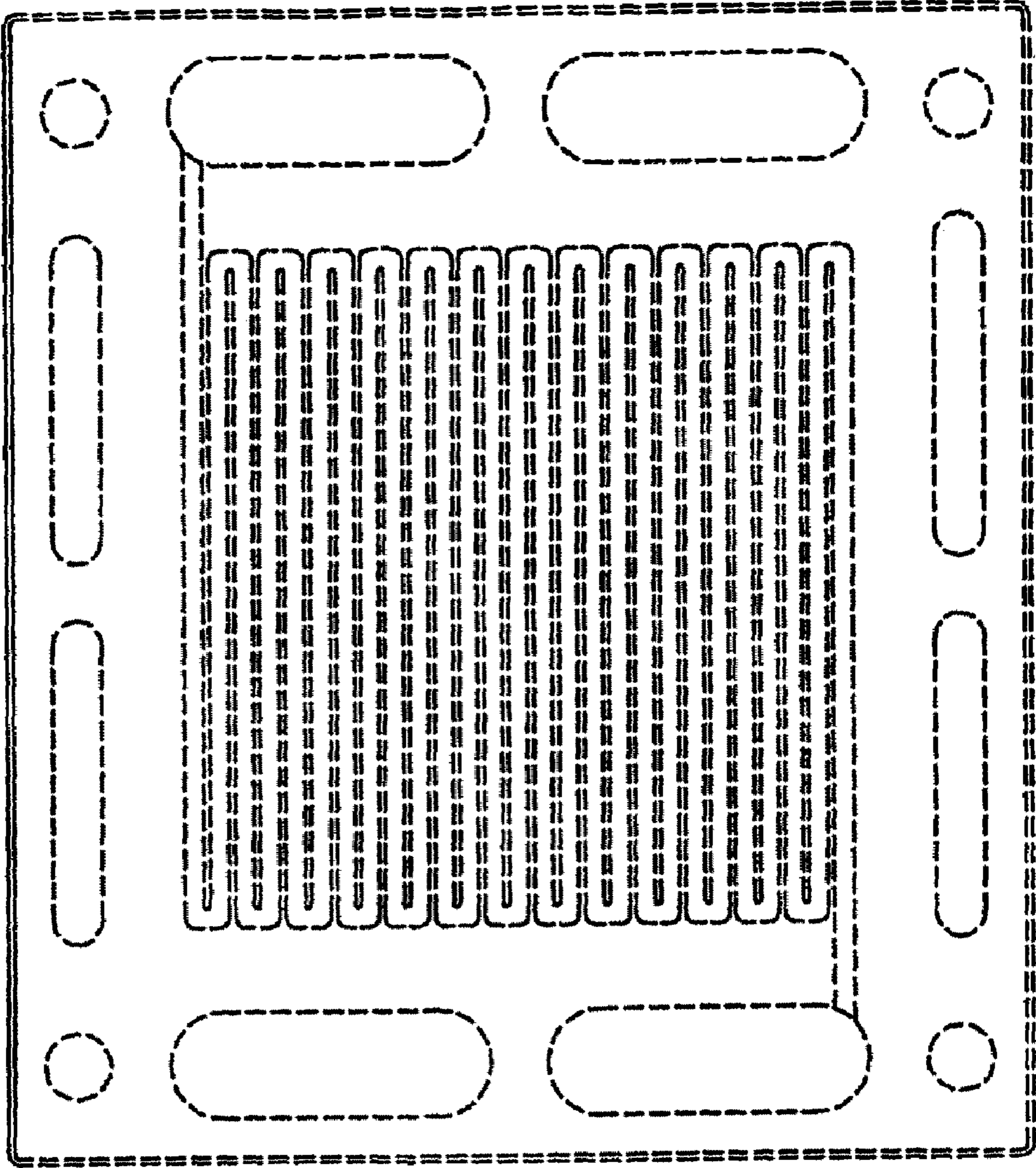

FIG. 3

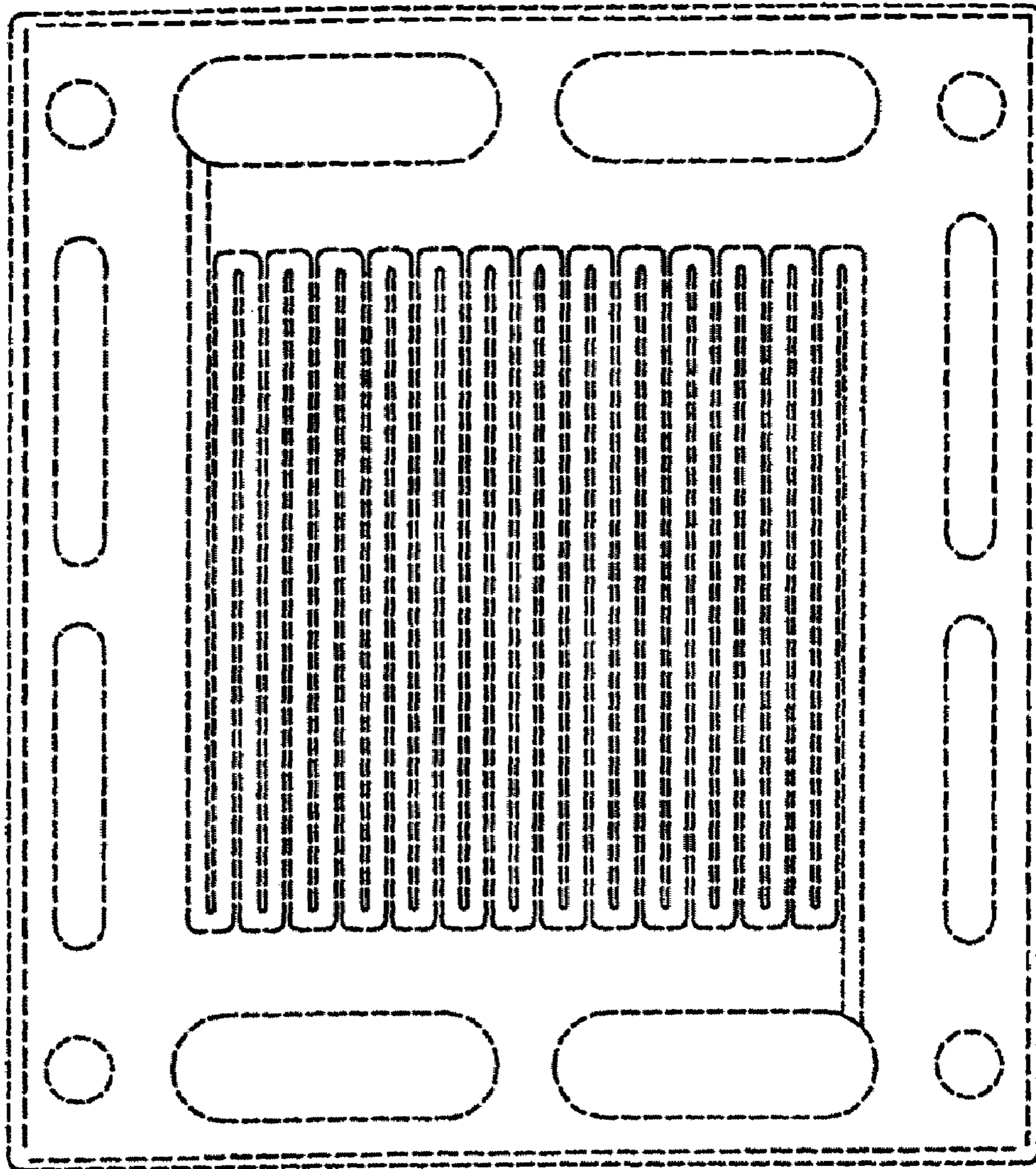

FIG. 4



FIG. 5



FIG. 6

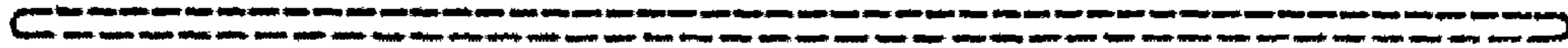

FIG. 7

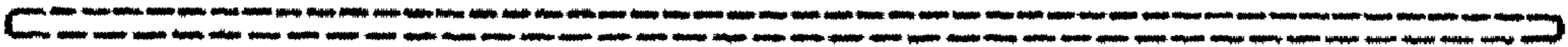

FIG. 8

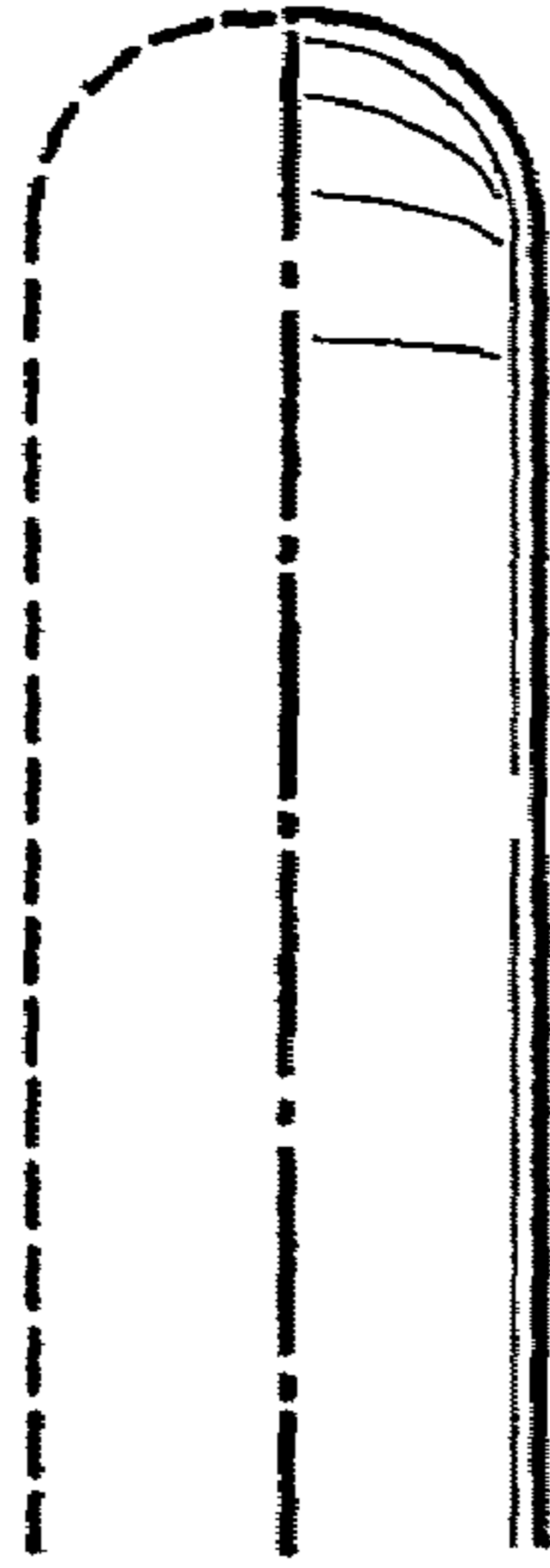

FIG. 9

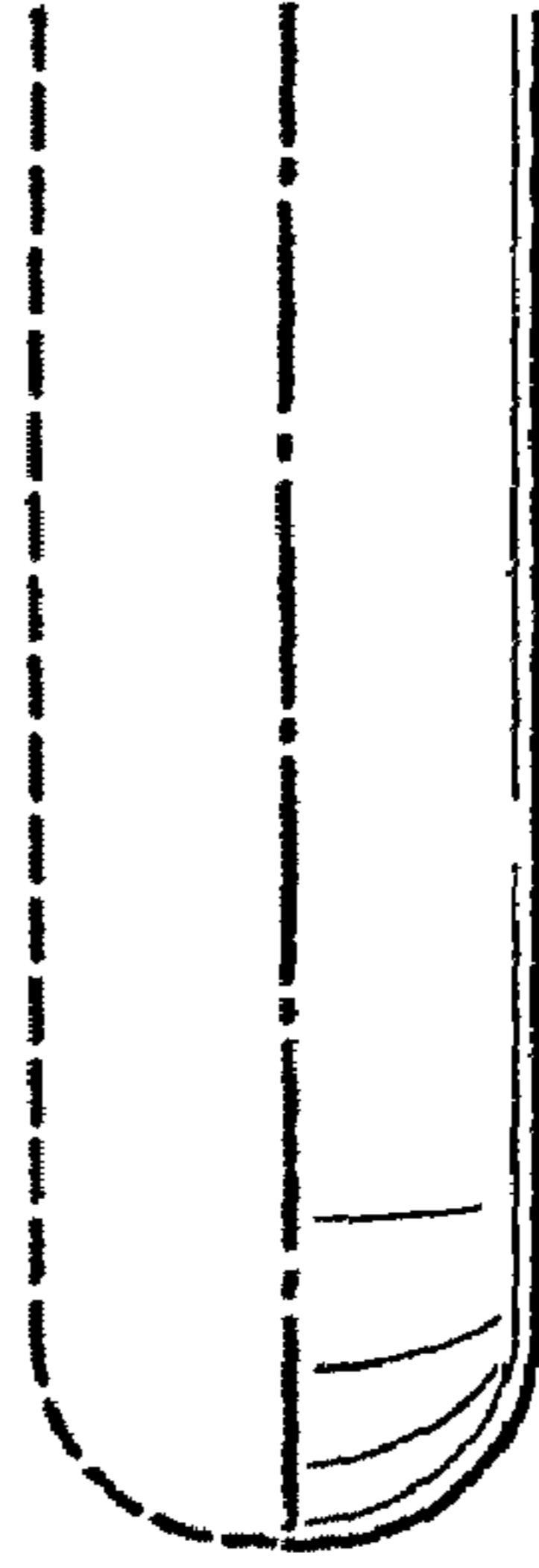

FIG. 10



FIG. 11

