



US00D596499S

(12) **United States Design Patent**  
**Willis et al.**

(10) **Patent No.:** **US D596,499 S**  
(45) **Date of Patent:** **\*\* Jul. 21, 2009**

(54) **FOOD CONTAINER**

(75) Inventors: **Rickelle Leigh Willis**, Atlanta, GA (US);  
**James Kyle Lovett**, Atlanta, GA (US)

(73) Assignee: **InnoWare Plastic, Inc.**, Alpharetta, GA  
(US)

(\*\*) Term: **14 Years**

(21) Appl. No.: **29/323,244**

(22) Filed: **Aug. 21, 2008**

(51) **LOC (9) Cl.** ..... **03-03**

(52) **U.S. Cl.** ..... **D9/761; D9/737; D9/424;**  
**D9/425**

(58) **Field of Classification Search** ..... **D9/737,**  
**D9/761, 759, 414-426, 430-432; D7/553.1,**  
**D7/553.6, 553.7, 553.8, 629, 602; 206/564,**  
**206/541; 220/4.23, 835, 839, 555, 575, 4.26,**  
**220/4.27, 556, 557, 553; 229/902-904, 906,**  
**229/406, 407, 110**

See application file for complete search history.

(56) **References Cited**

**U.S. PATENT DOCUMENTS**

D254,776 S *	4/1980	Edwards	.....	D9/426
D282,245 S *	1/1986	Yeung	.....	D9/425
D339,744 S *	9/1993	Seppala	.....	D9/425
D380,965 S *	7/1997	Correll	.....	D9/430

D387,986 S *	12/1997	Hayes et al.	.....	D9/435
D407,014 S *	3/1999	McCann	.....	D9/423
D408,282 S *	4/1999	McCann	.....	D9/423
D408,733 S *	4/1999	McCann	.....	D9/423
D408,734 S *	4/1999	McCann	.....	D9/423
D522,355 S *	6/2006	Castellanos et al.	.....	D9/425

\* cited by examiner

*Primary Examiner*—Stella M Reid

*Assistant Examiner*—Mark A Goodwin

(74) *Attorney, Agent, or Firm*—Baker Donelson Bearman  
Caldwell & Berkowitz PC

(57) **CLAIM**

The ornamental design for a food container, as shown and described.

**DESCRIPTION**

FIG. 1 is a perspective view of a food container showing our new design;

FIG. 2 is a top view thereof;

FIG. 3 is a bottom view thereof;

FIG. 4 is a right side view thereof;

FIG. 5 is a front view thereof;

FIG. 6 is a left side view thereof; and,

FIG. 7 is a rear view thereof.

**1 Claim, 4 Drawing Sheets**

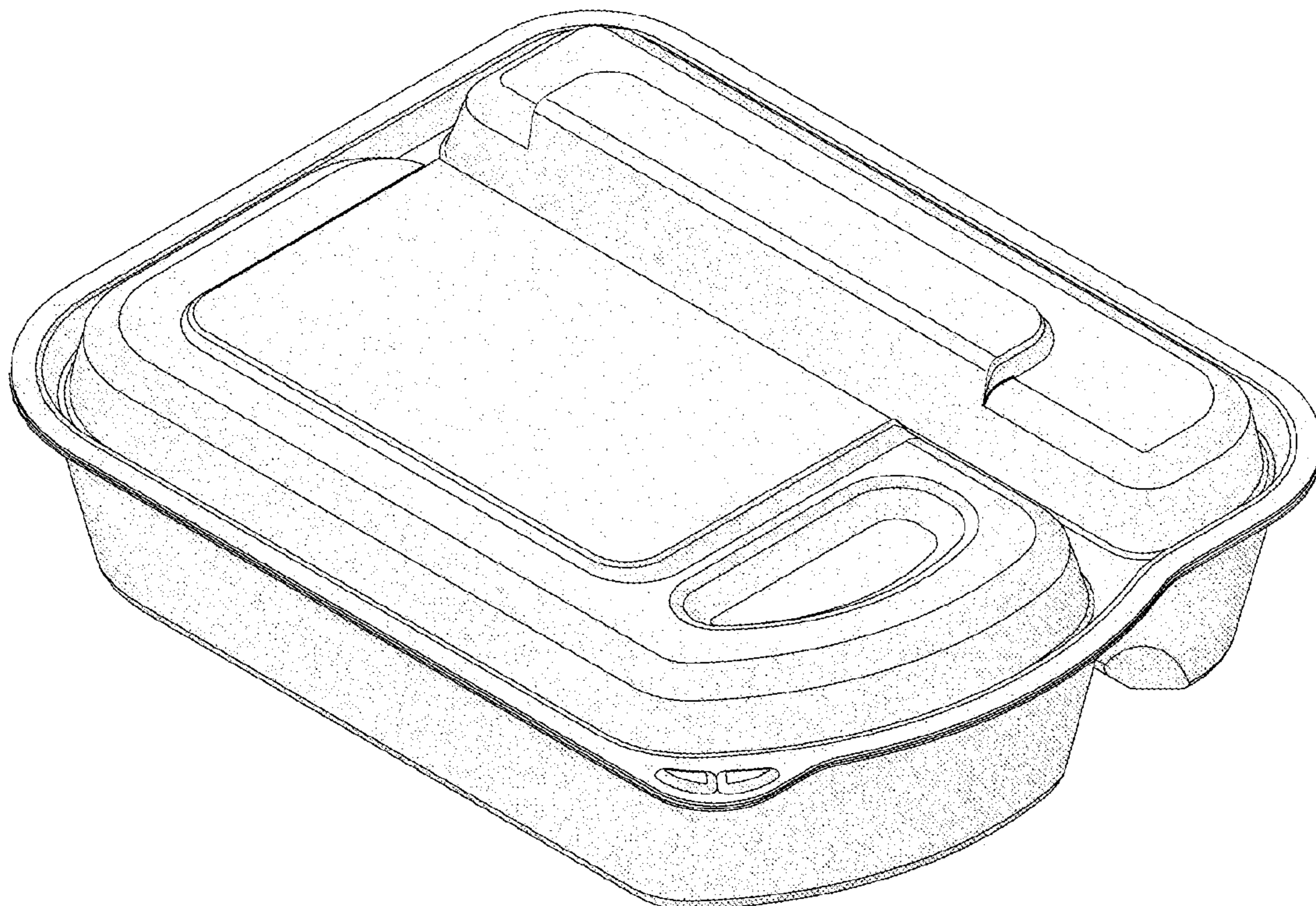

Fig. 1

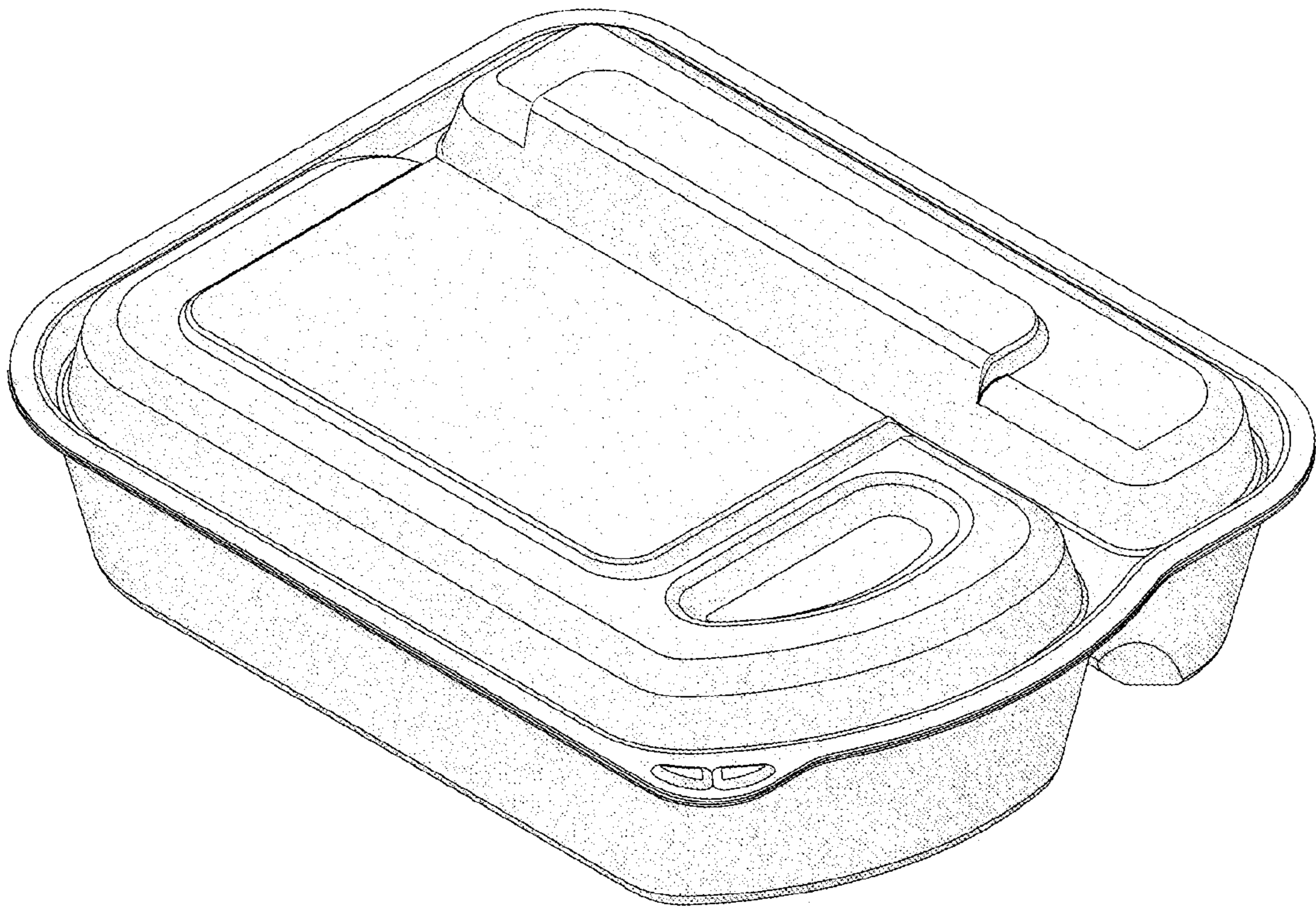

Fig. 2

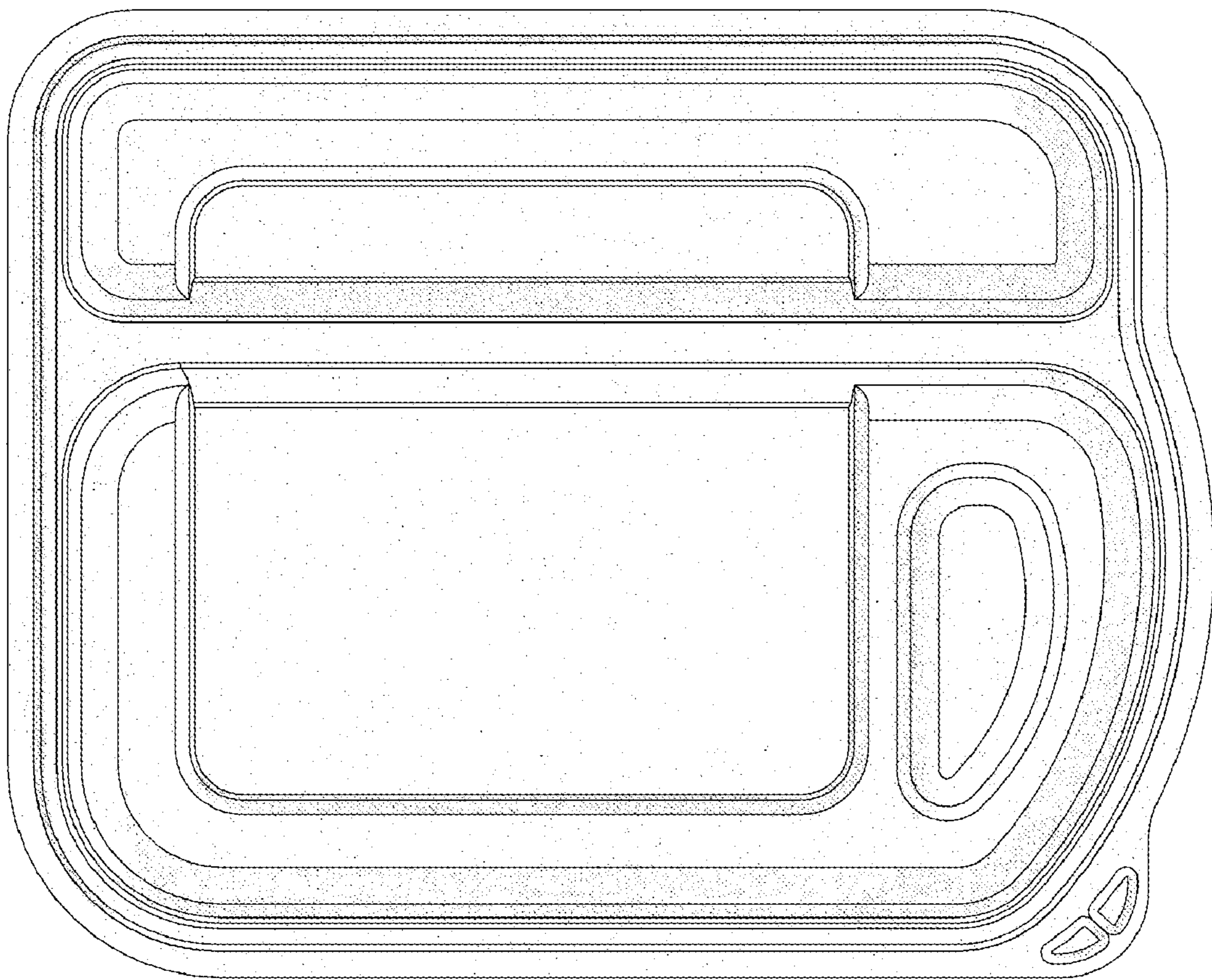

Fig. 3

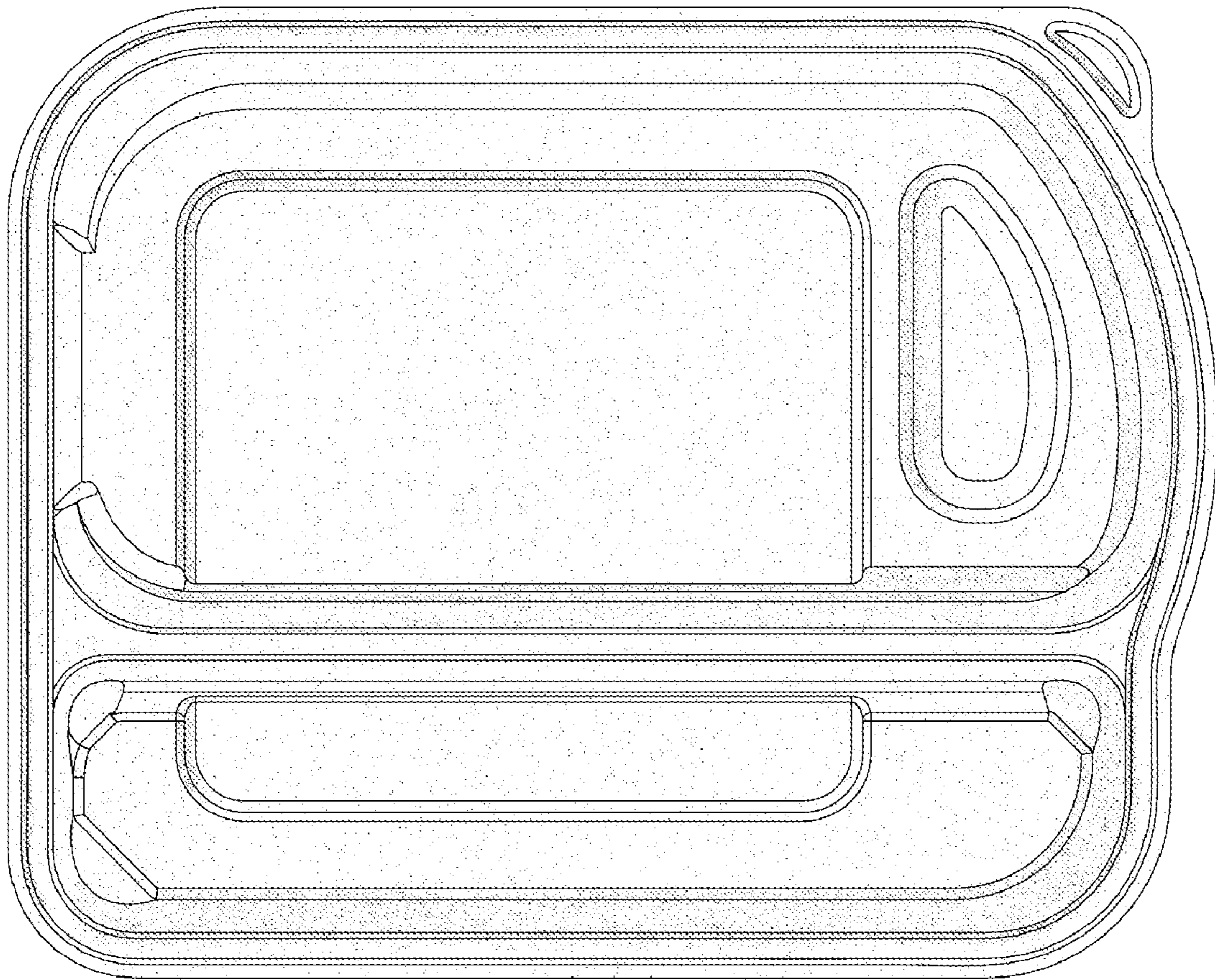

Fig. 4

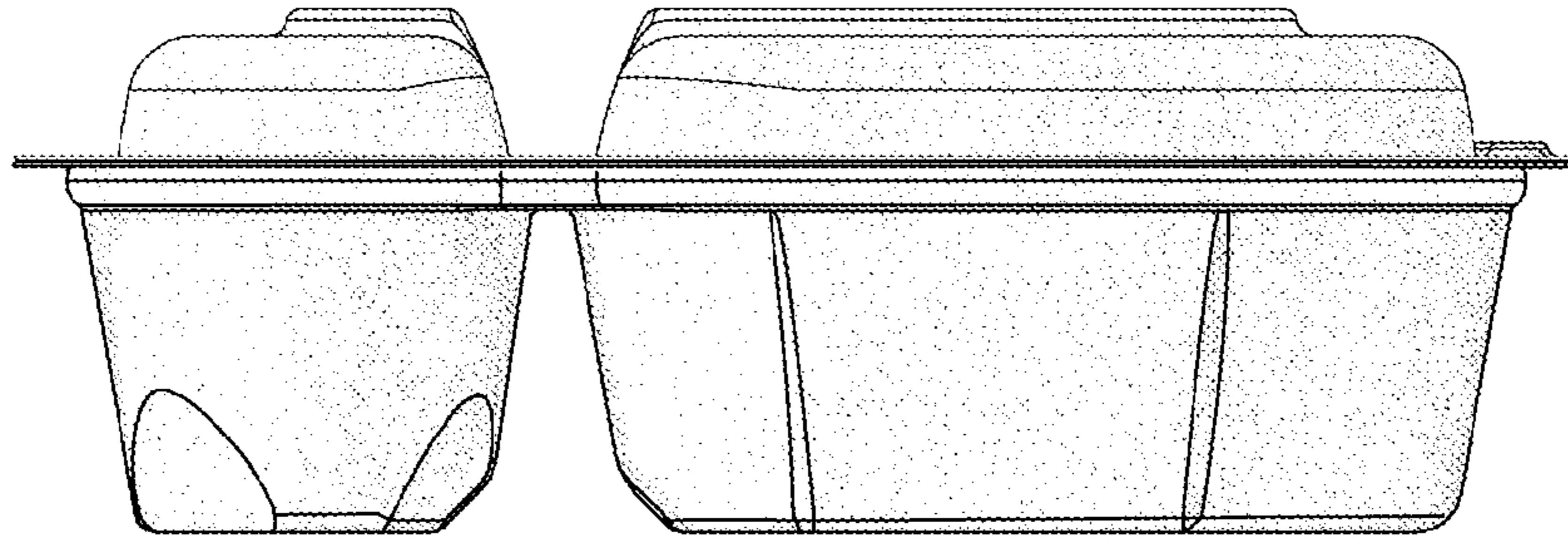

Fig. 5

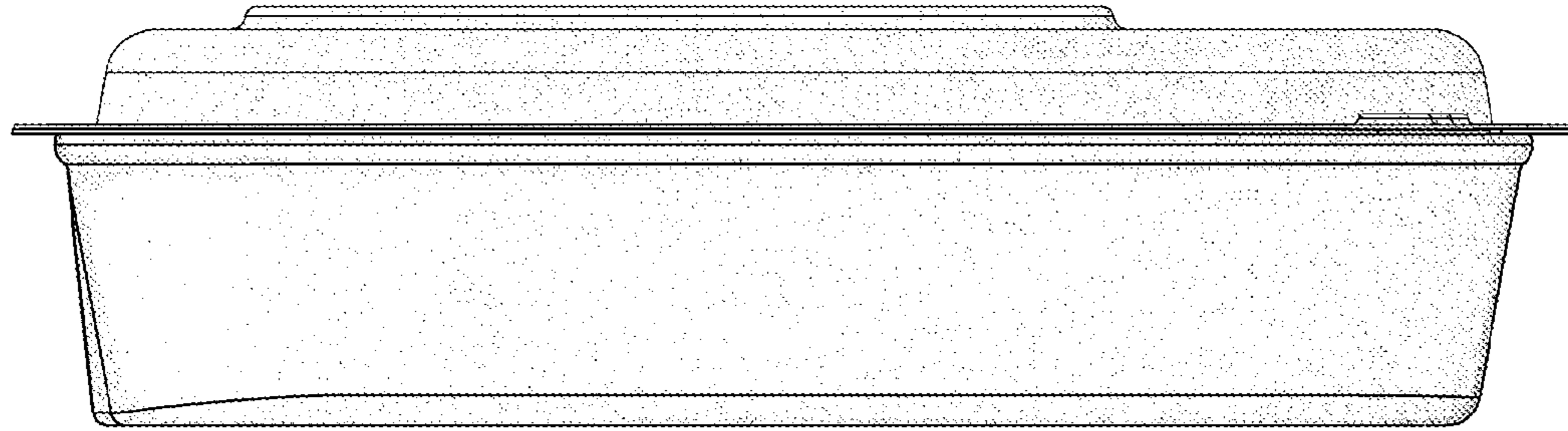

Fig. 6

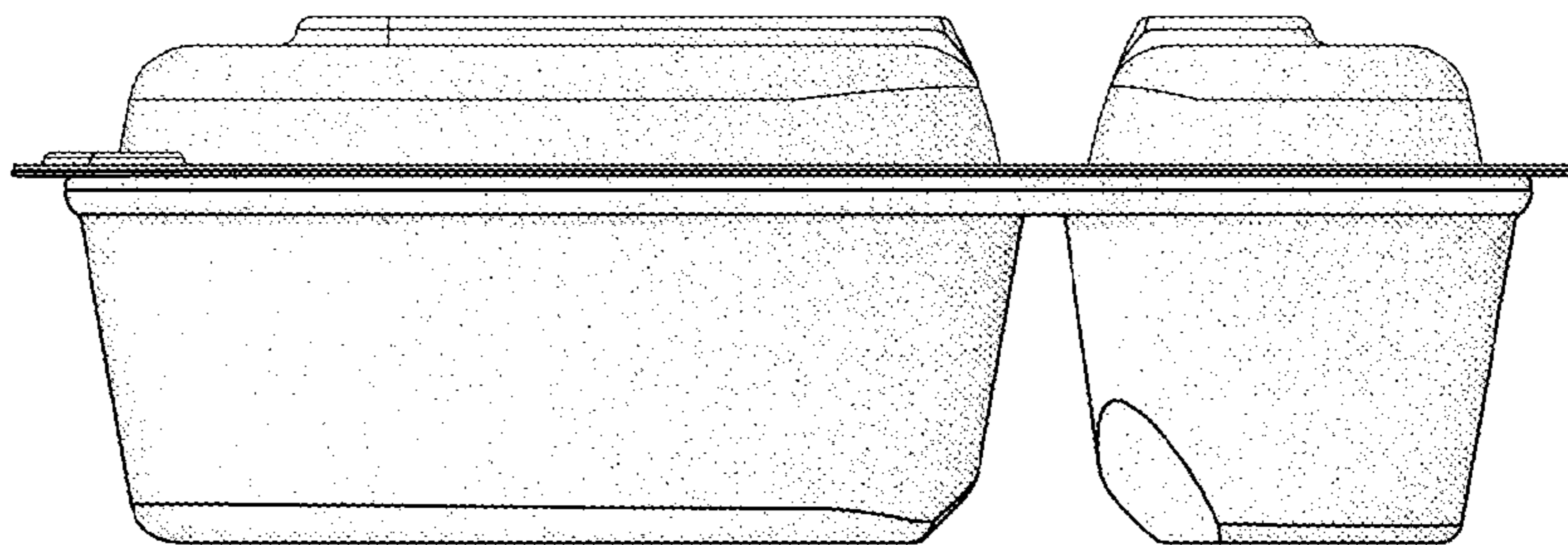

Fig. 7

