

US00D596432S

(12) **United States Design Patent**  
**Sarkar et al.**

(10) **Patent No.:** **US D596,432 S**  
(45) **Date of Patent:** **\*\* Jul. 21, 2009**

(54) **DISPENSER**

D558,401 S \* 12/2007 Hadtke et al. .... D28/66

(75) Inventors: **Matthew Neil Sarkar**, Cambridge (GB);  
**Roger William Clarke**, Cambridge  
(GB); **Stephen William Eason**, Norfolk  
(GB); **Graham Roger Gibbins**, Holt  
(GB)

FOREIGN PATENT DOCUMENTS		
GB	EC 000521315-0001	6/2006
JP	D1213934	6/2004
KR	KP-30-1992-0000433	1/1992
KR	KP-30-2004-0003019	2/2004
TW	401169	5/1987
TW	D103462	3/2005
TW	D103812	3/2005

(73) Assignee: **Vectura Delivery Devices Limited**,  
Wiltshire (GB)

\* cited by examiner

(\*\*) Term: **14 Years**

*Primary Examiner*—Brian N Vinson

(21) Appl. No.: **29/300,862**

(74) *Attorney, Agent, or Firm*—Venable LLP; Robert  
Kinberg; Kyle D. Petaja

(22) Filed: **May 22, 2008**

(30) **Foreign Application Priority Data**

(57) **CLAIM**

Nov. 23, 2007 (EM) ..... 000831730-0001/0002

The ornamental design for a dispenser, as shown.

(51) **LOC (9) Cl.** ..... **20-02**

**DESCRIPTION**

(52) **U.S. Cl.** ..... **D6/515**

FIG. 1 is a front elevation view of the first embodiment of the  
dispenser showing our new design;

(58) **Field of Classification Search** ..... D6/515–523;  
206/225, 233, 389, 391, 812, 824, 63.5; 211/13.1,  
211/45; 222/173, 180; 221/16, 33, 282–283;  
242/925, 570, 590; 248/309.1, 309.2, 905;  
D9/307, 521, 529, 419, 420; D3/20, 301;  
D28/66

FIG. 2 is a rear view of the design shown in FIG. 1;

FIG. 3 is a left side view of the design shown in FIG. 1;

FIG. 4 is a right side view of the design shown in FIG. 1;

FIG. 5 is a top view of the design shown in FIG. 1;

FIG. 6 is bottom view of the design shown in FIG. 1;

FIG. 7 is a back-top-left perspective view of the design shown  
in FIG. 1;

FIG. 8 is a front-top-right perspective view of the design  
shown in FIG. 1; and,

FIG. 9 is a front elevation view of a second embodiment of the  
dispenser showing our new design where the only difference  
between the first and second embodiment of the dispenser is  
a longer vertical dimension.

See application file for complete search history.

(56) **References Cited**

U.S. PATENT DOCUMENTS

D399,603 S	*	10/1998	Hemsley et al.	.....	D28/66
D416,411 S	*	11/1999	Carlson et al.	.....	D6/515
D422,785 S	*	4/2000	Cavell	.....	D3/201
D475,282 S	*	6/2003	Snaith et al.	.....	D9/420
D493,576 S	*	7/2004	Ward	.....	D28/66
D507,715 S	*	7/2005	Yang et al.	.....	D6/515
D510,461 S	*	10/2005	Vu	.....	D28/66
D544,150 S	*	6/2007	Aledo et al.	.....	D28/66

**1 Claim, 9 Drawing Sheets**

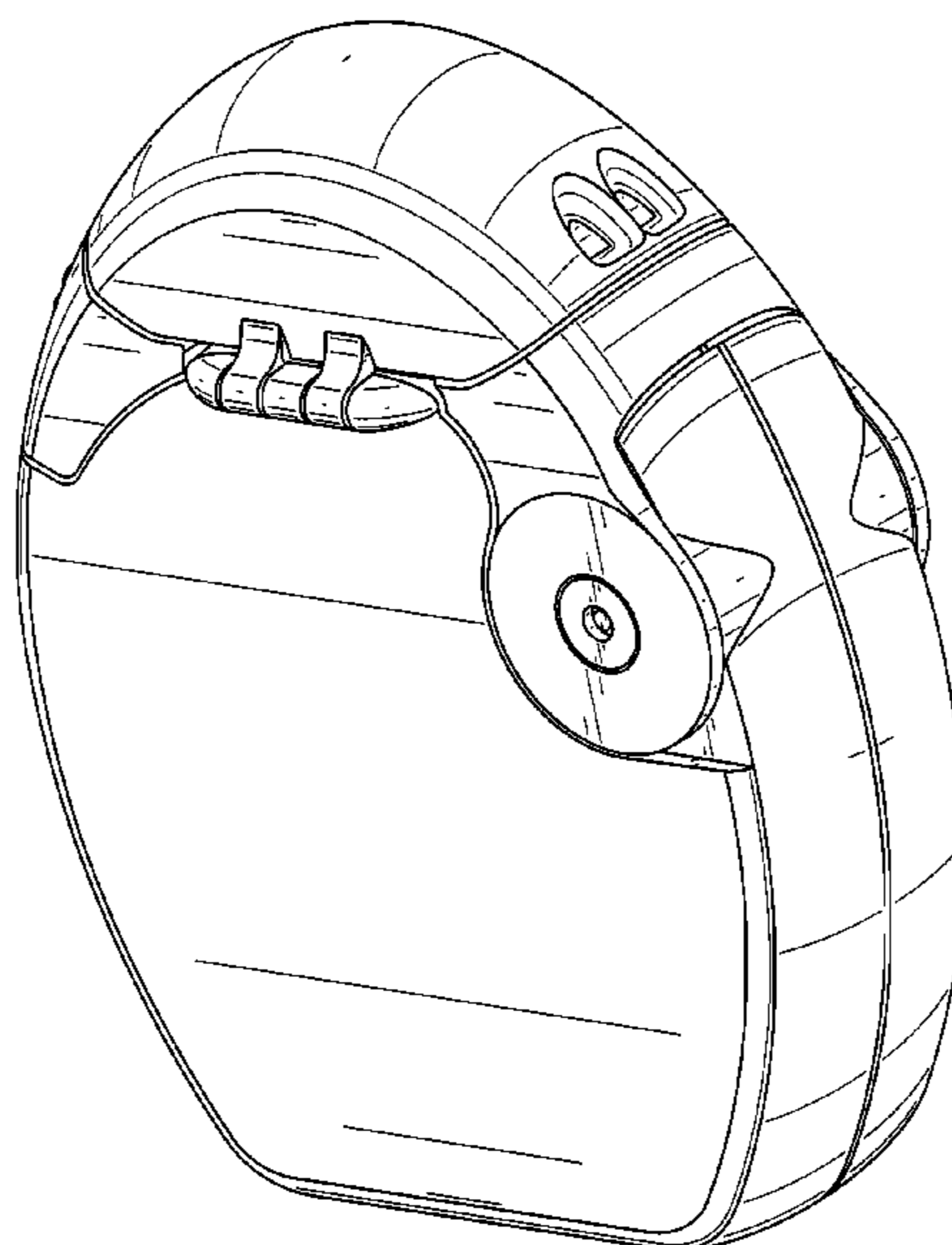

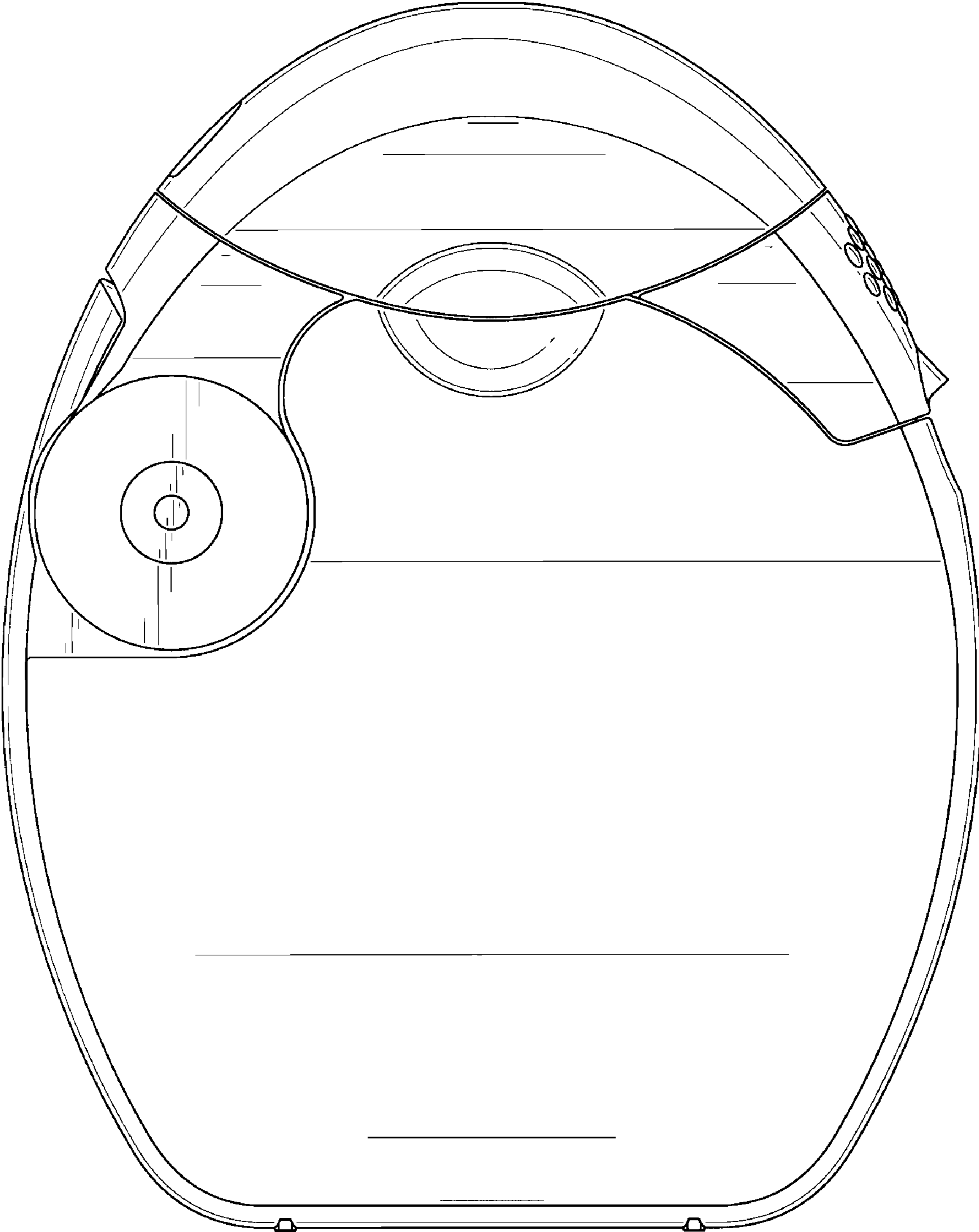

FIG. 1

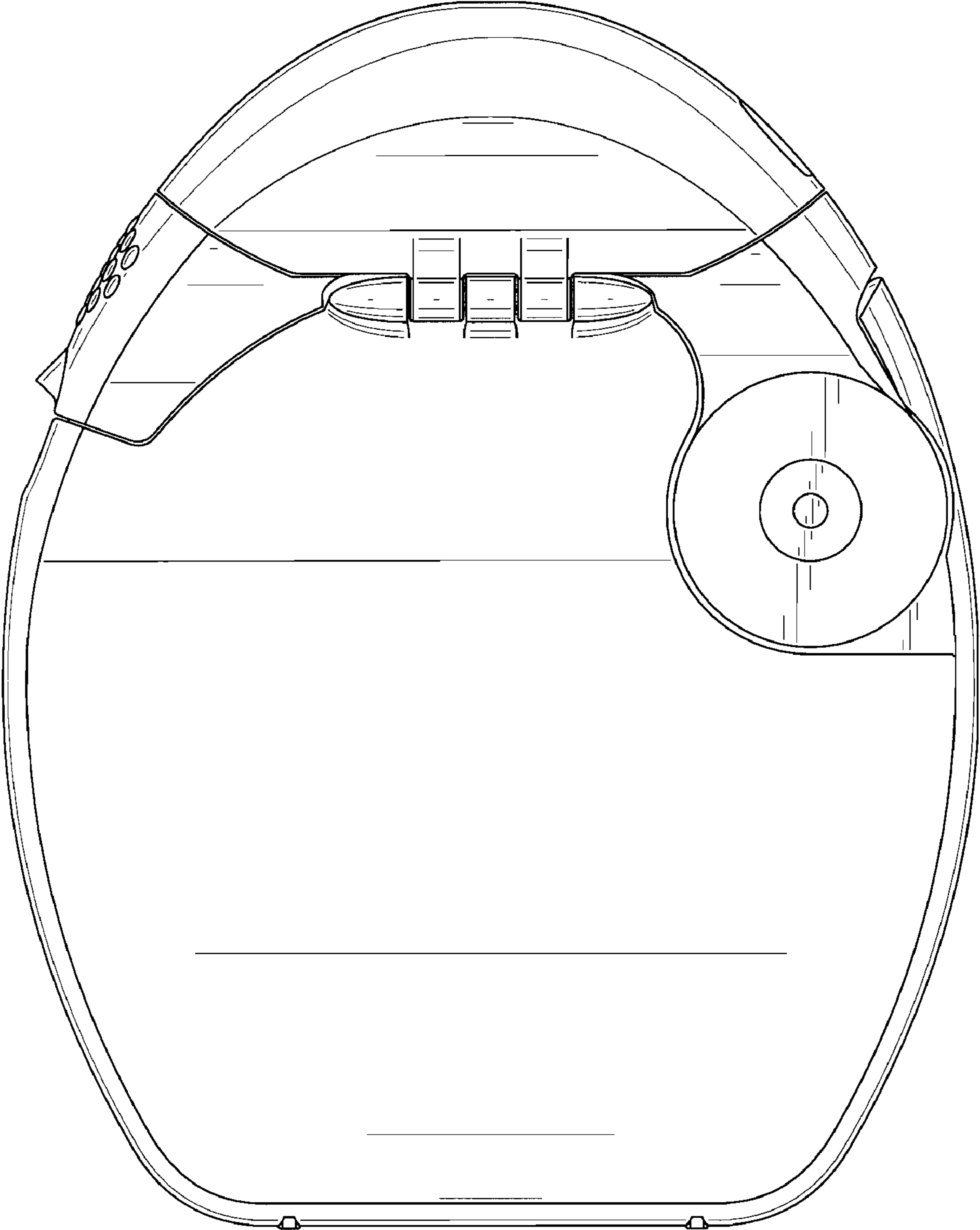

FIG. 2

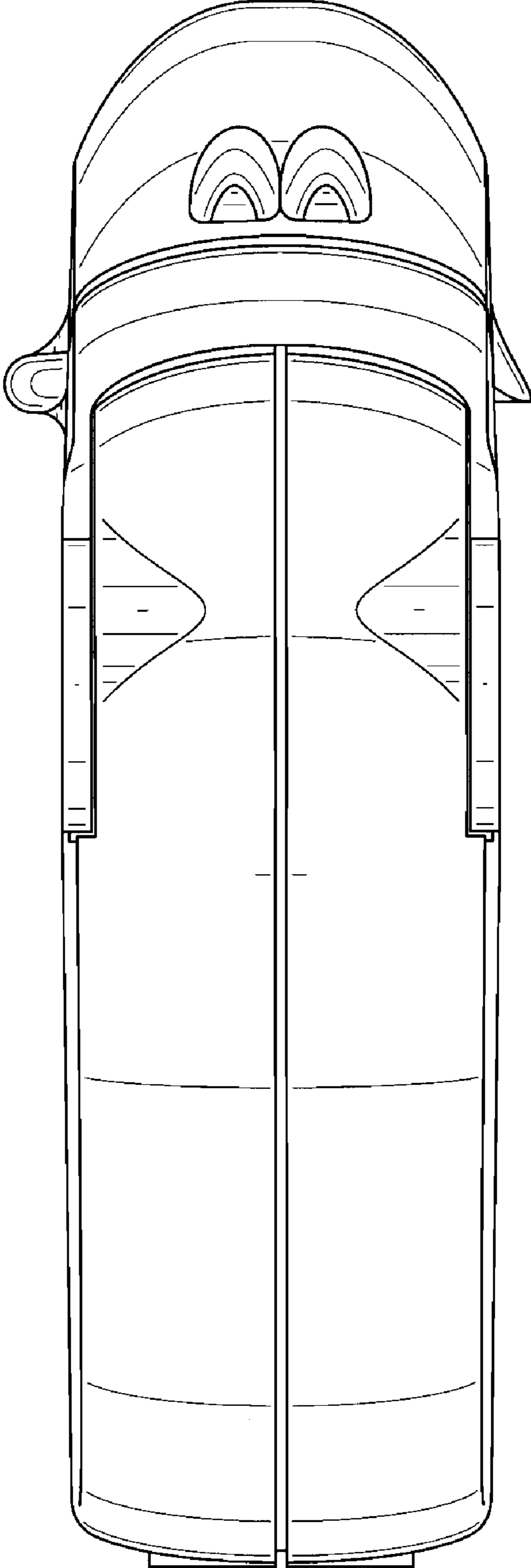

FIG. 3

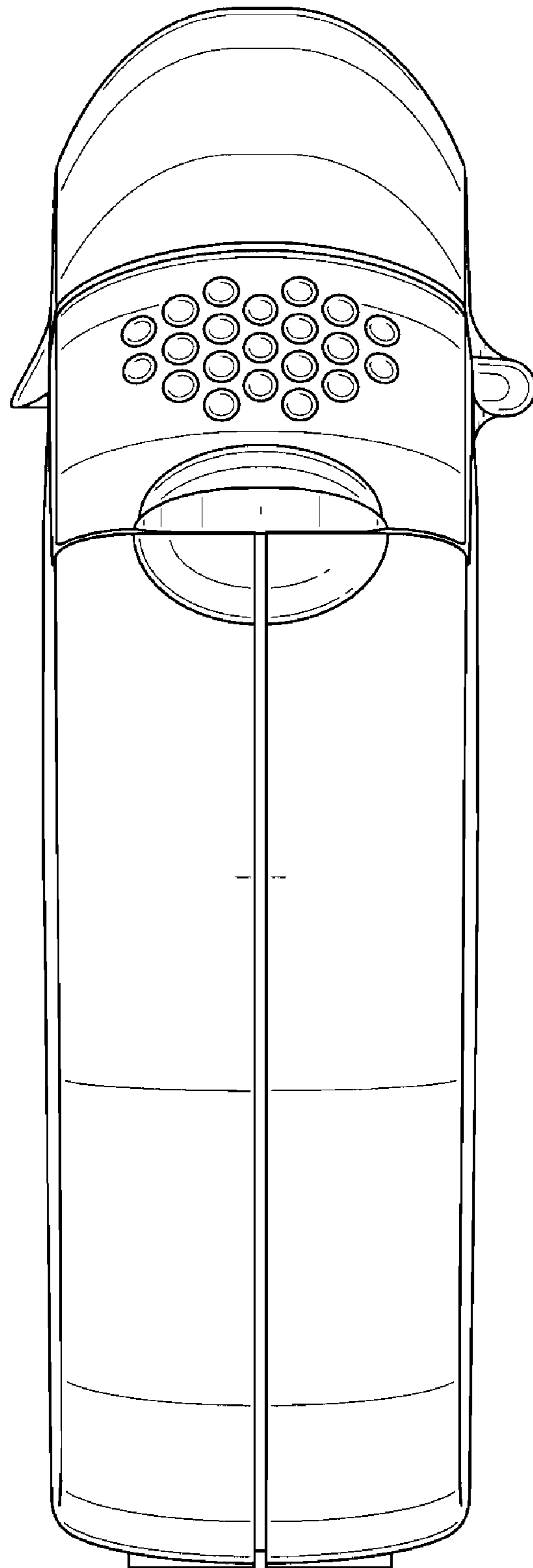

FIG. 4

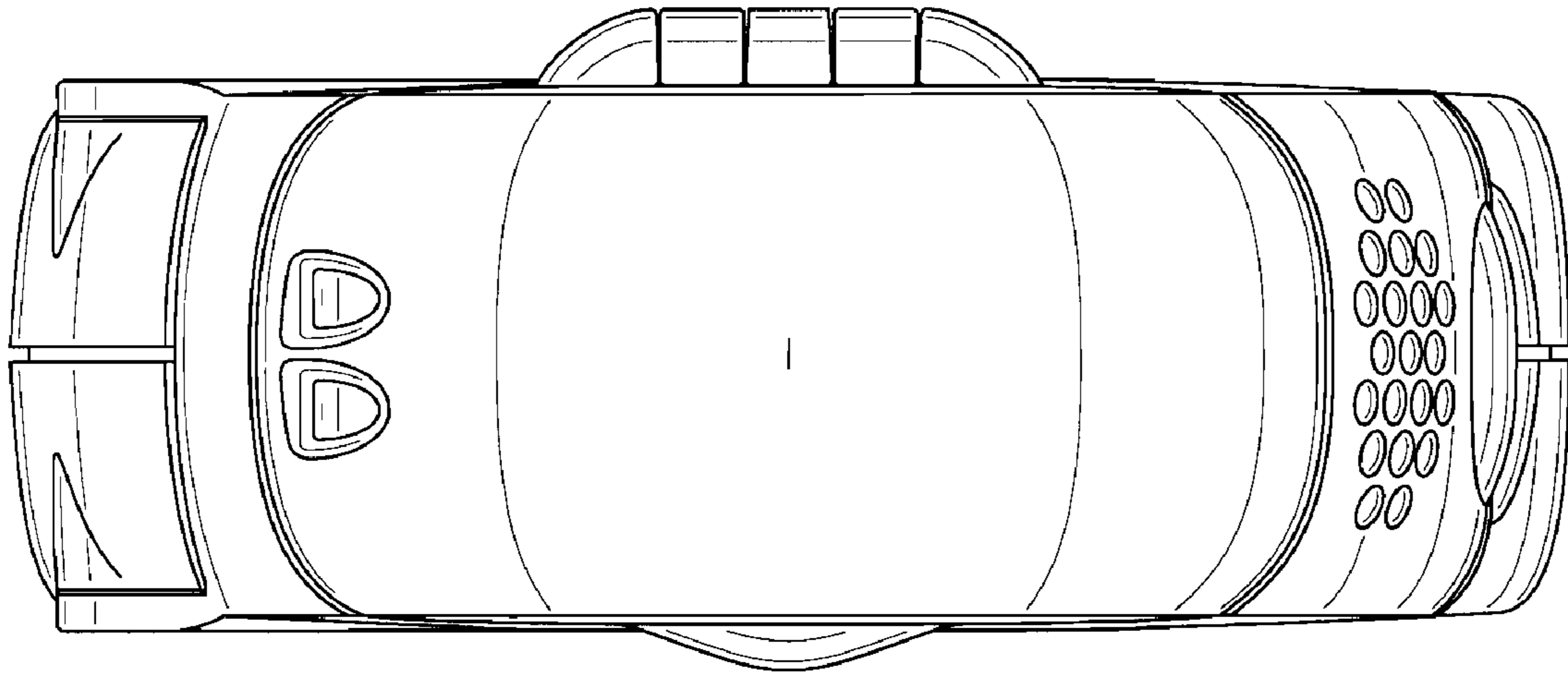

FIG. 5

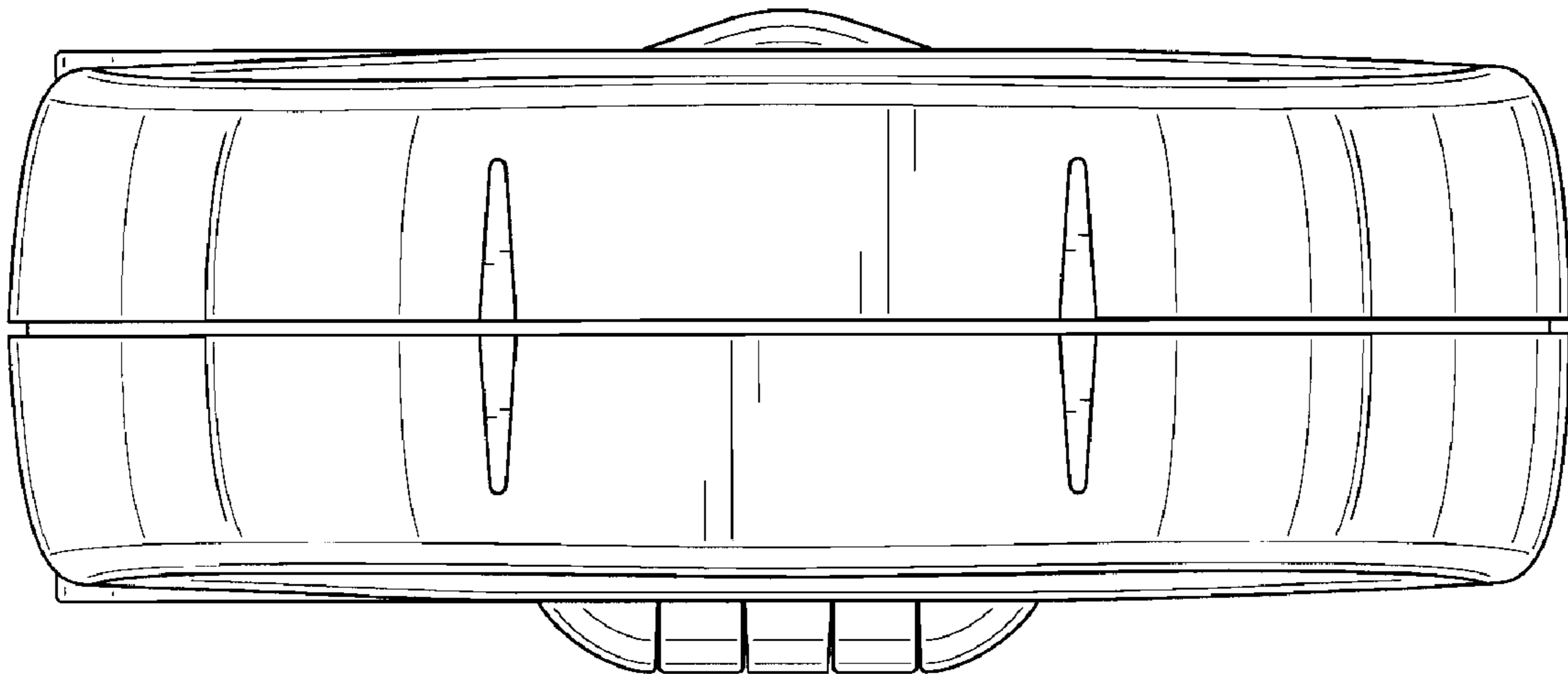

FIG. 6

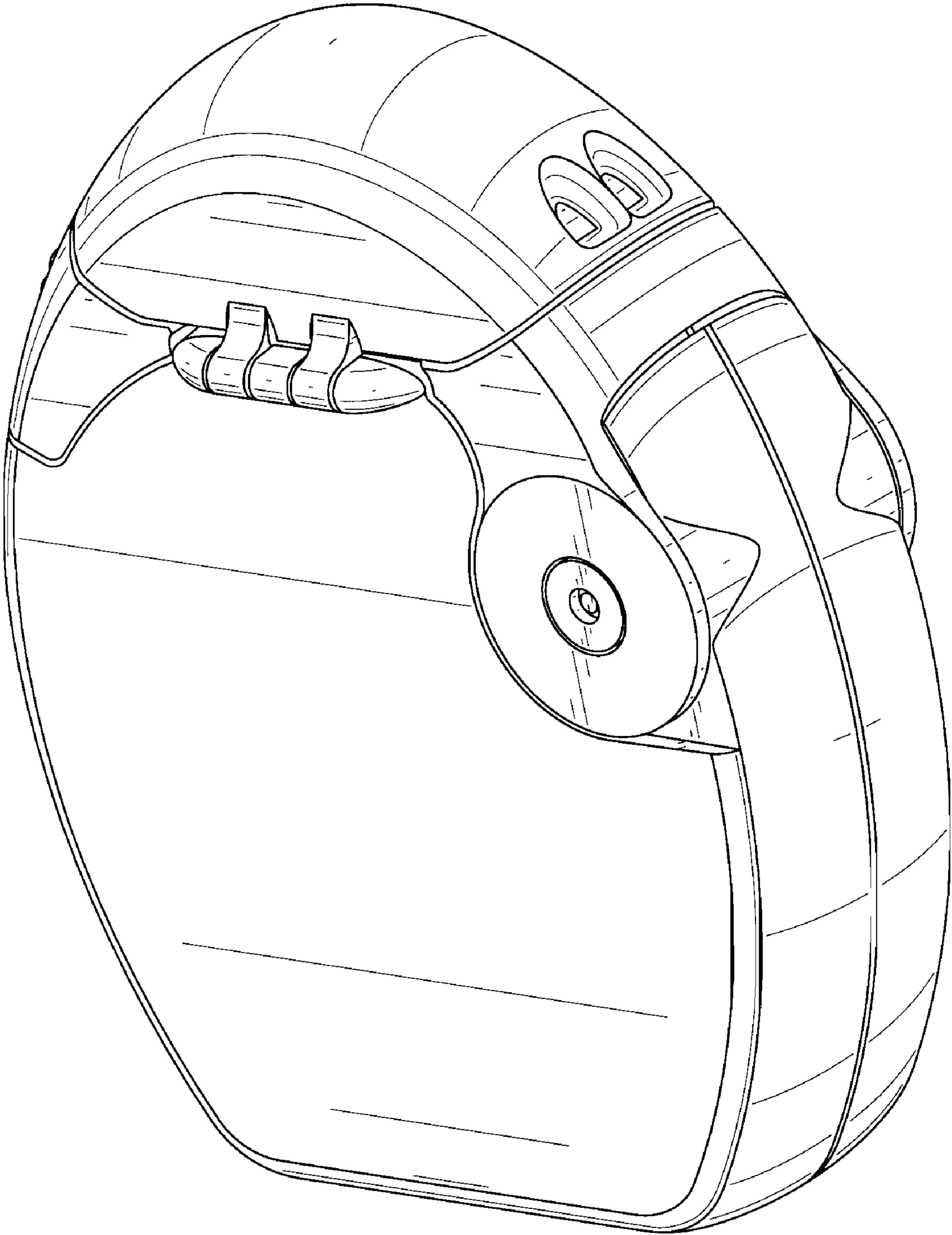

FIG. 7



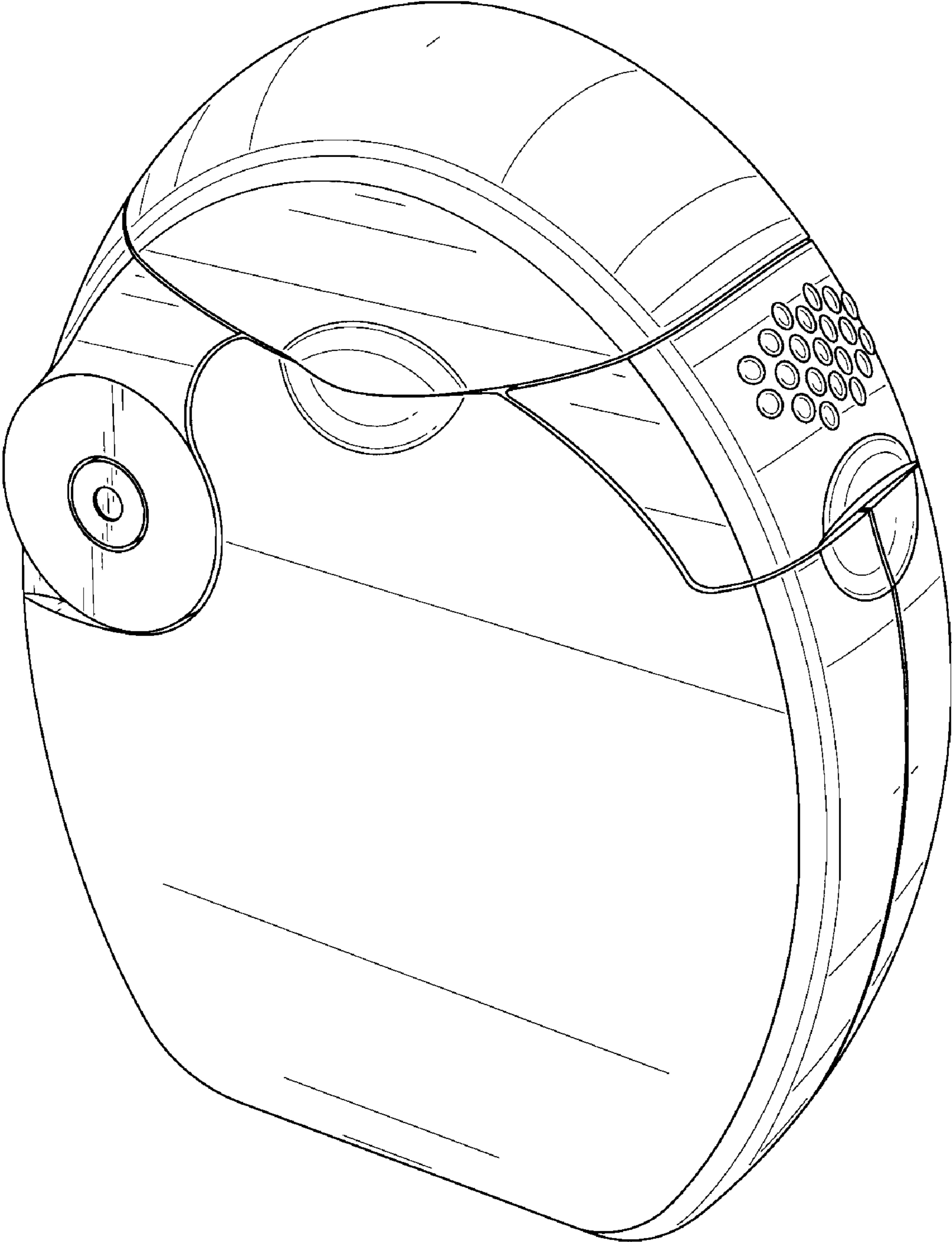

FIG. 8

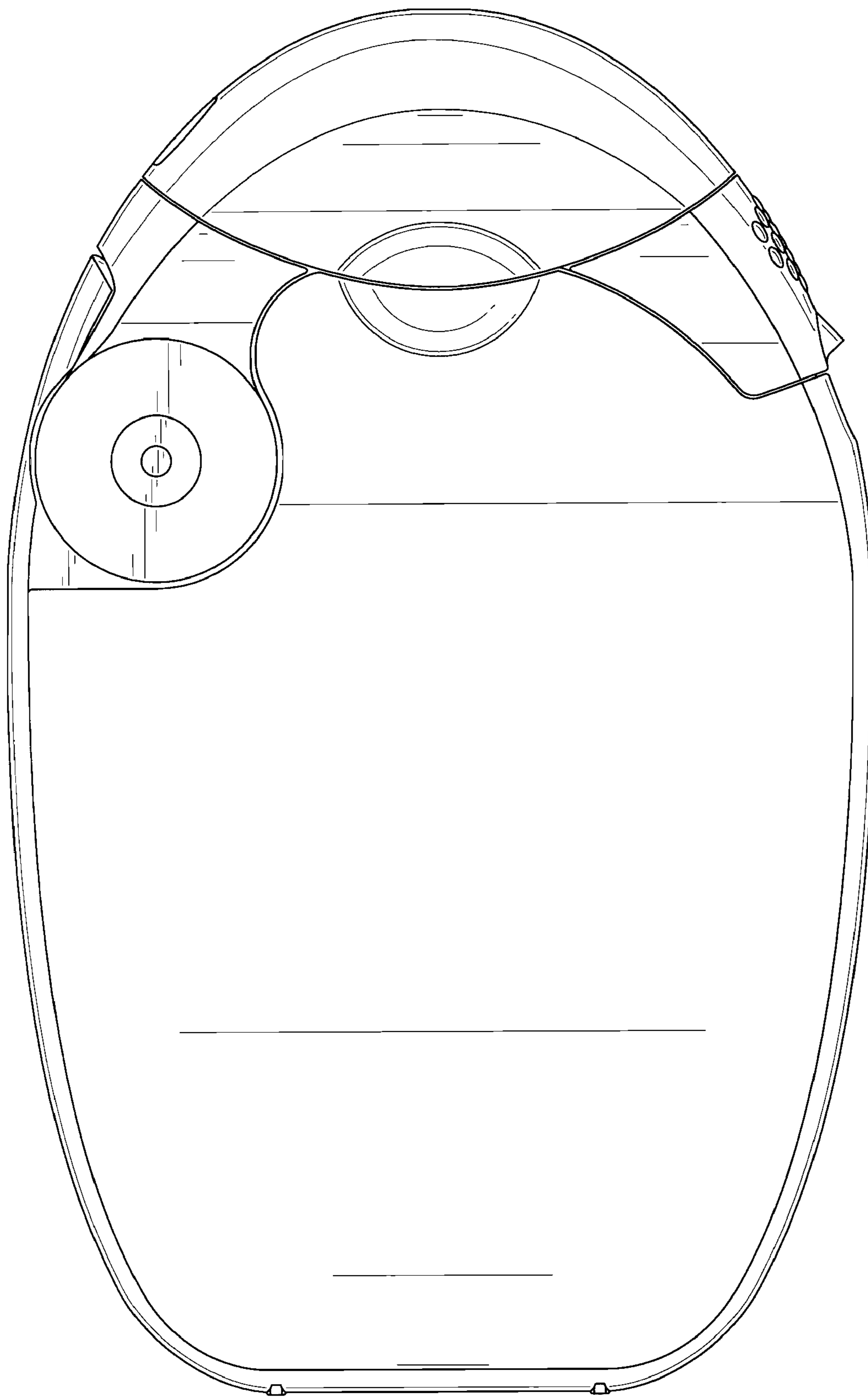

FIG. 9