



US00D596295S

(12) **United States Design Patent**  
**Hedström et al.**

(10) **Patent No.:** **US D596,295 S**  
(45) **Date of Patent:** **\*\* Jul. 14, 2009**

(54) **BONE ANCHORED HEARING AID**

(75) Inventors: **Anton Hedström**, Göteborg (SE); **Patric Svensson**, Göteborg (SE)

(73) Assignee: **Oticon A/S**, Smorum (DK)

(\*\*) Term: **14 Years**

(21) Appl. No.: **29/317,948**

(22) Filed: **May 9, 2008**

(30) **Foreign Application Priority Data**

Nov. 11, 2007 (EM) ..... 000835400-0001

(51) **LOC (9) Cl.** ..... **24-99**

(52) **U.S. Cl.** ..... **D24/174**

(58) **Field of Classification Search** ..... D24/173-175,  
D24/106, 182; D14/205, 217, 218, 223,  
D14/224, 249; 381/23.1, 312, 322, 323,  
381/324, 328, 330, 380, 381; 181/129, 130,  
181/134, 135, 137

See application file for complete search history.

(56) **References Cited**

**U.S. PATENT DOCUMENTS**

D206,665 S \* 1/1967 Sanzone ..... D24/174  
D207,212 S \* 3/1967 Geib ..... D24/174  
D208,784 S \* 10/1967 Sanzone ..... D24/174

D287,764 S \* 1/1987 Topholm ..... D24/174  
D455,835 S \* 4/2002 Anderson et al. .... D24/174  
D519,994 S \* 5/2006 Kettula et al. .... D14/205  
D529,175 S \* 9/2006 Franz et al. .... D24/151  
D532,520 S \* 11/2006 Kampmeier et al. .... D24/174

\* cited by examiner

*Primary Examiner*—T. Chase Nelson

*Assistant Examiner*—Anhdao Doan

(74) *Attorney, Agent, or Firm*—Birch, Stewart, Kolasch & Birch, LLP

(57) **CLAIM**

The ornamental design for a bone anchored hearing aid, as shown and described.

**DESCRIPTION**

FIG. 1 is a rear view of the bone anchored hearing aid;  
FIG. 2 is a bottom view of the bone anchored hearing aid;  
FIG. 3 is a front view of the bone anchored hearing aid;  
FIG. 4 is a perspective view of the bone anchored hearing aid;  
FIG. 5 is a left side view of the bone anchored hearing aid;  
FIG. 6 is a right side view of the bone anchored hearing aid;  
and,  
FIG. 7 is a top view of the bone anchored hearing aid.

**1 Claim, 4 Drawing Sheets**

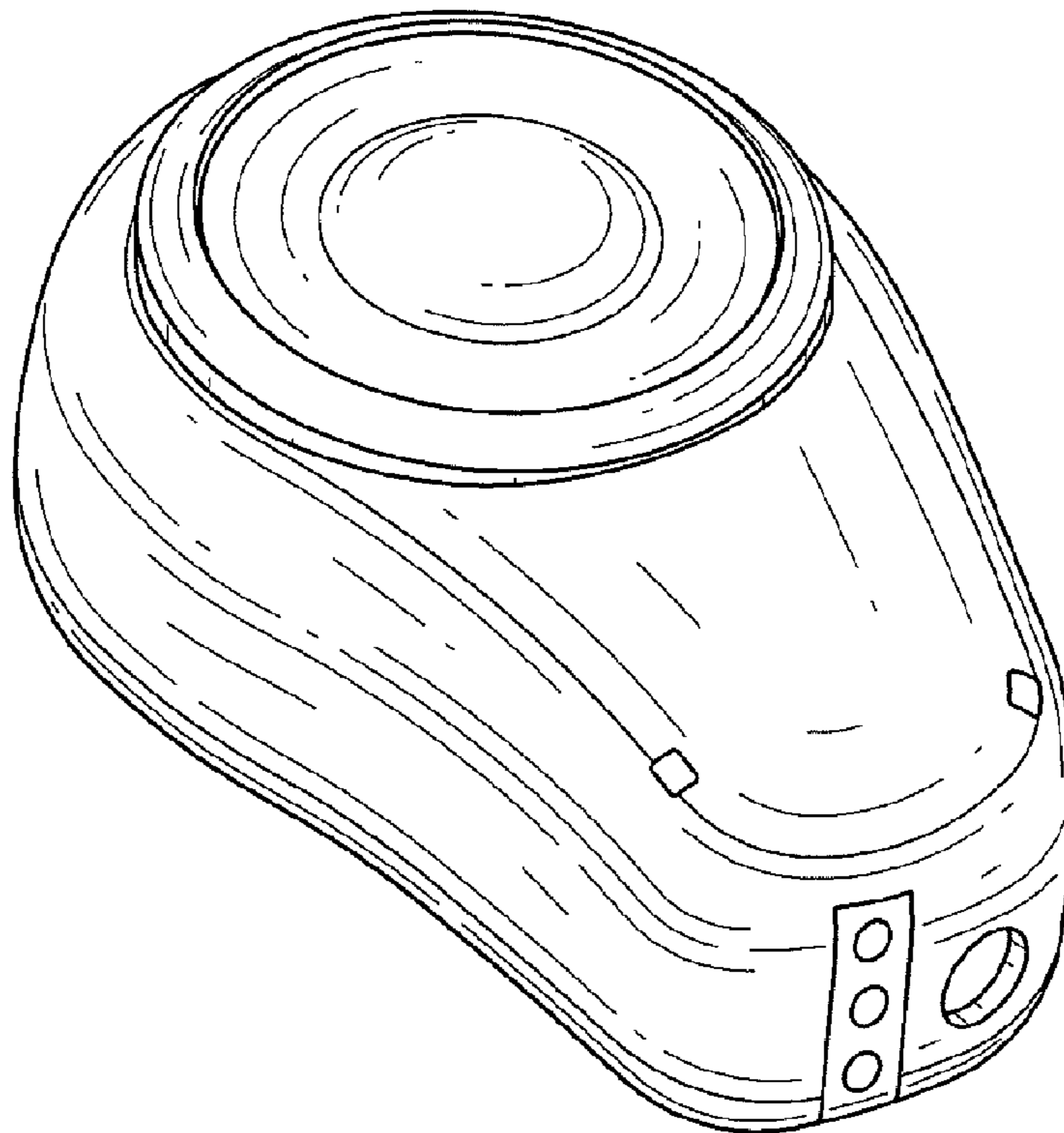

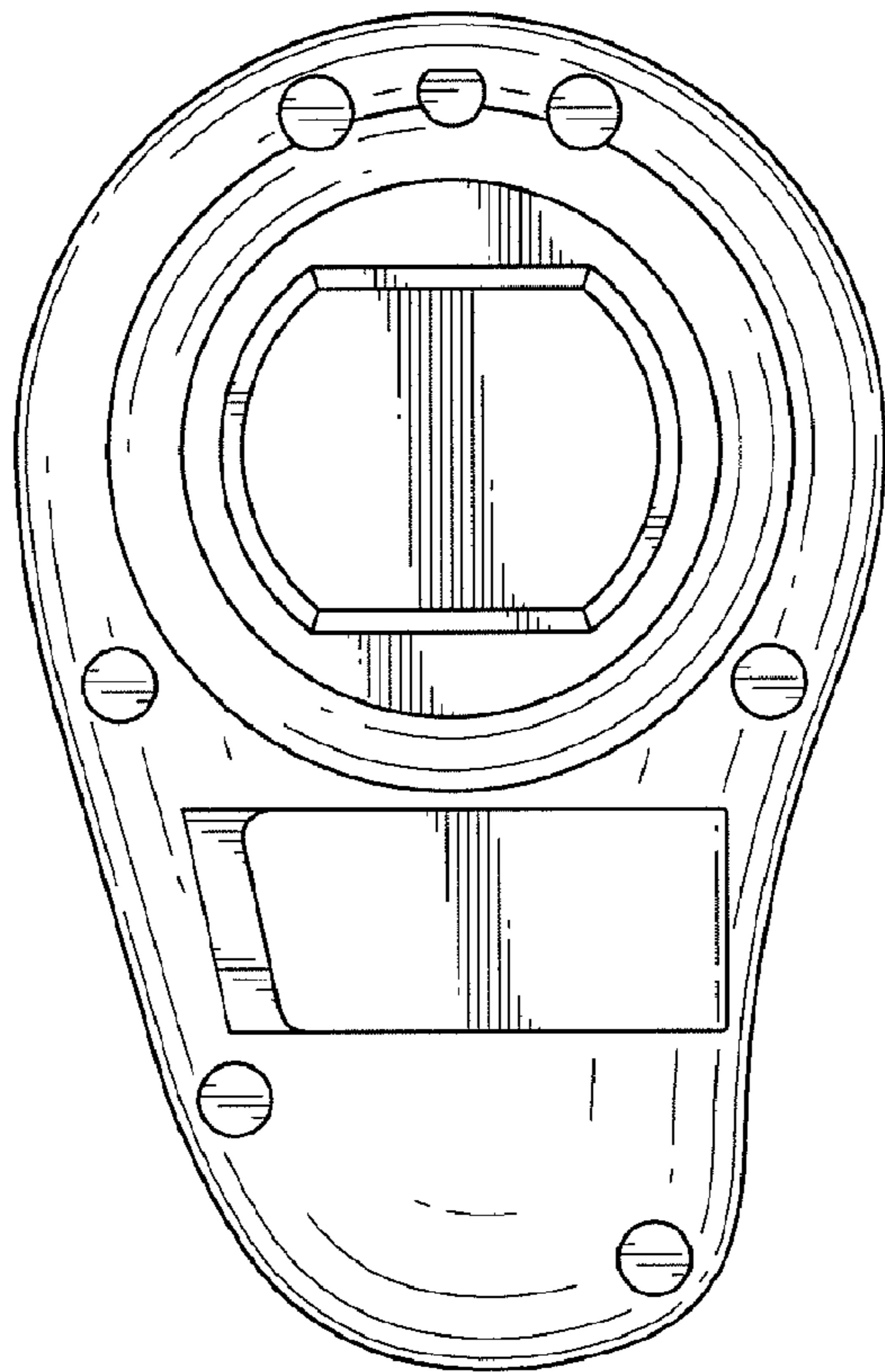

FIG. 1

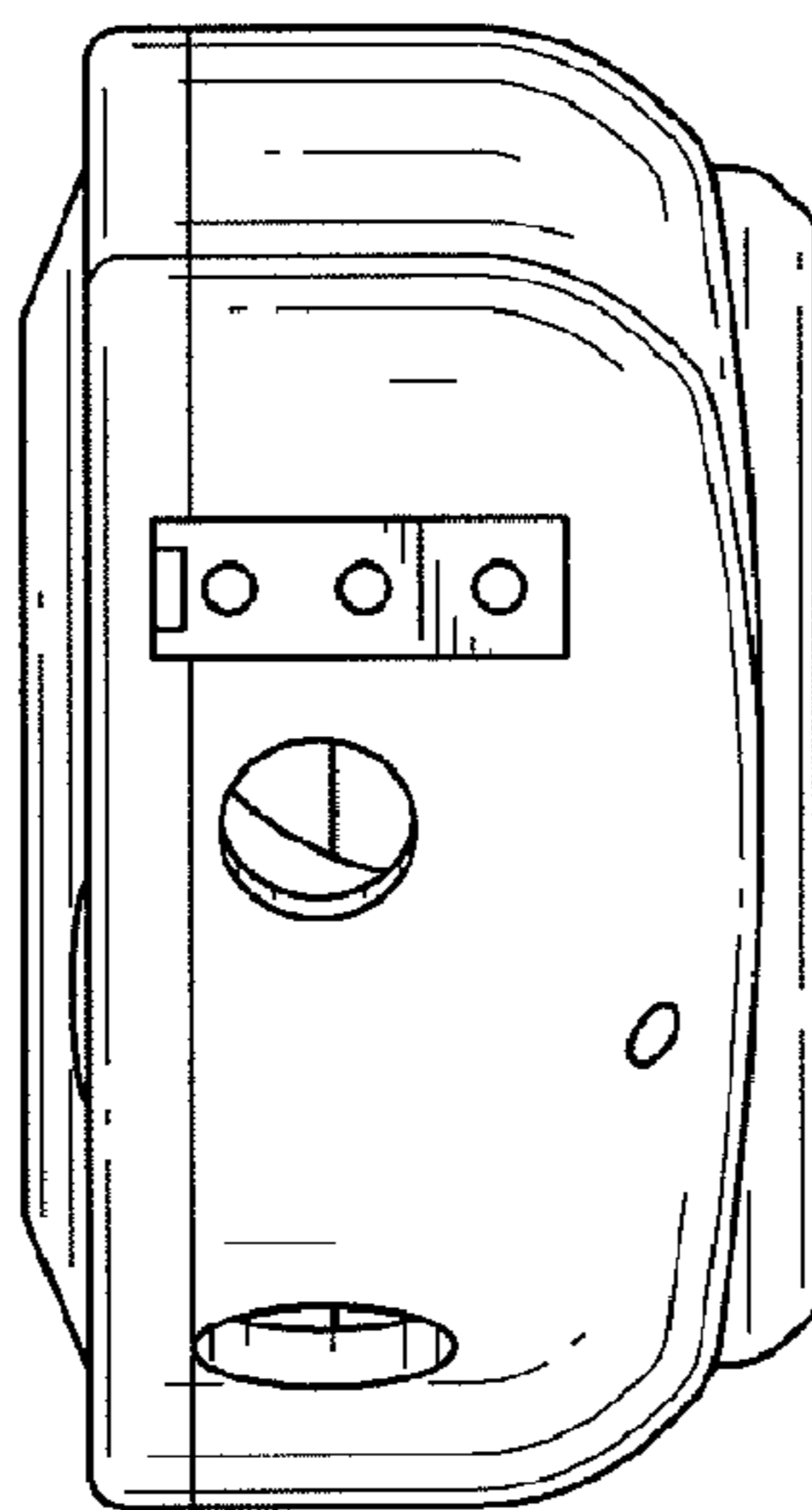

FIG. 2

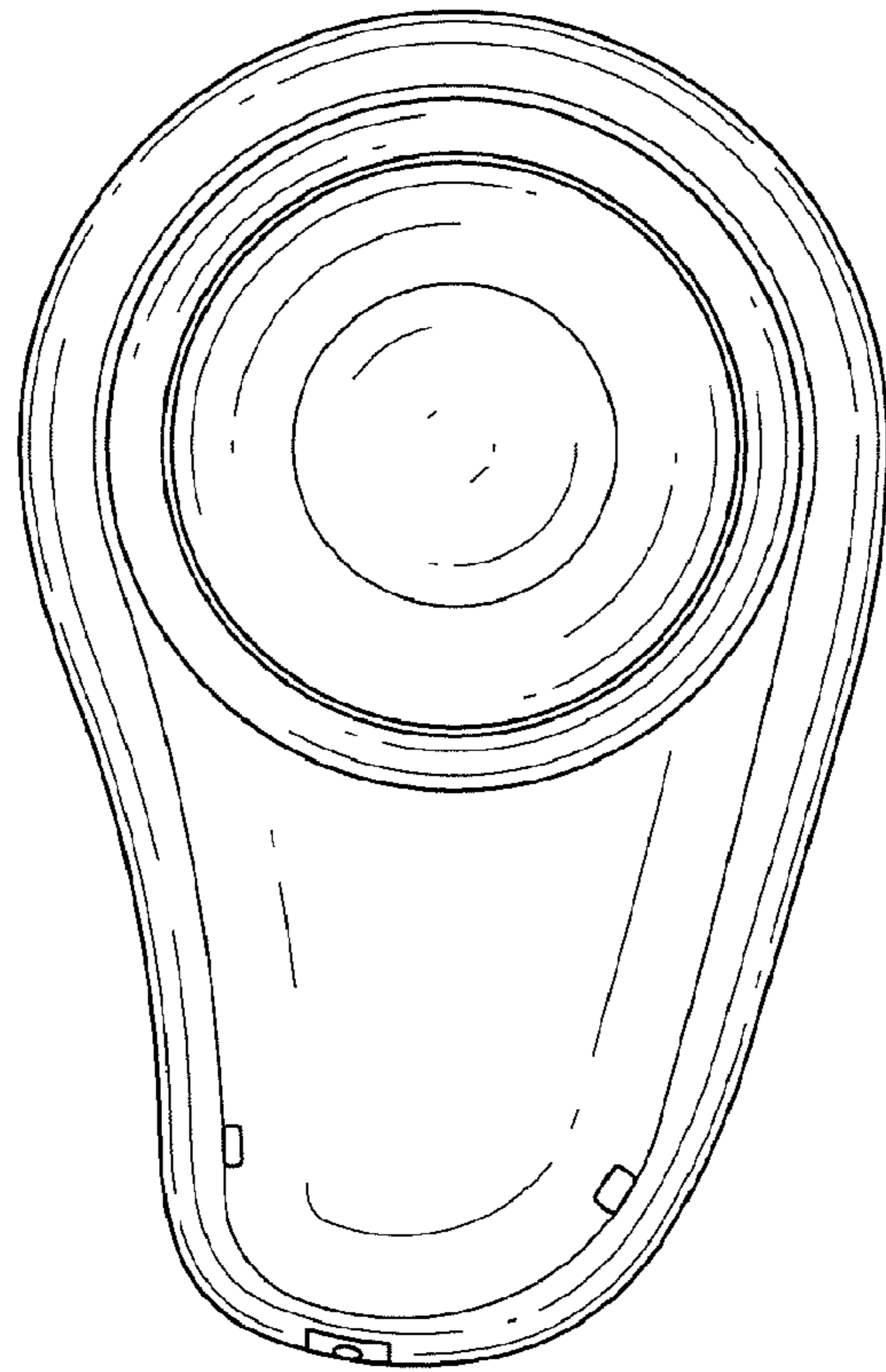

FIG.3

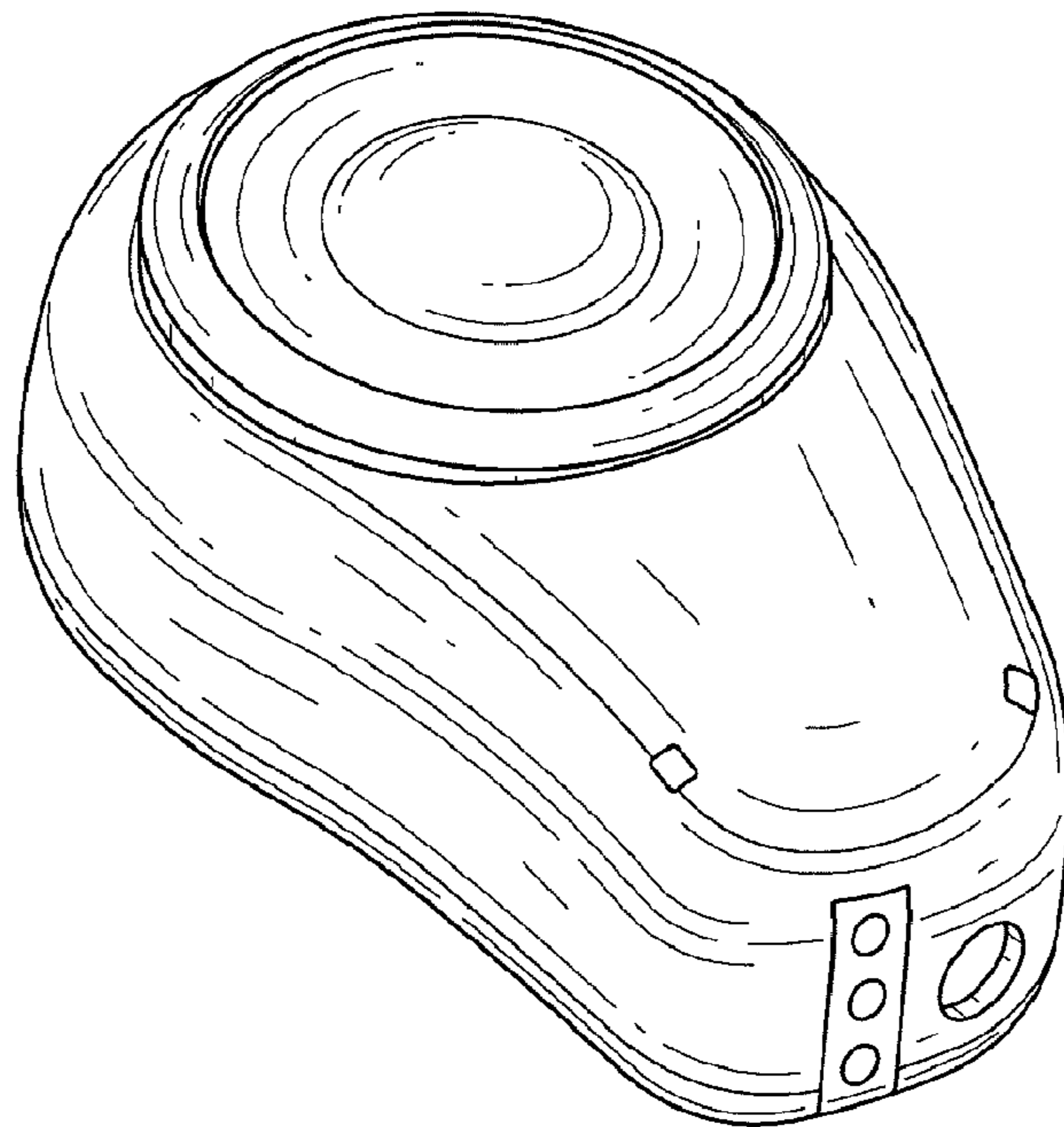

FIG.4

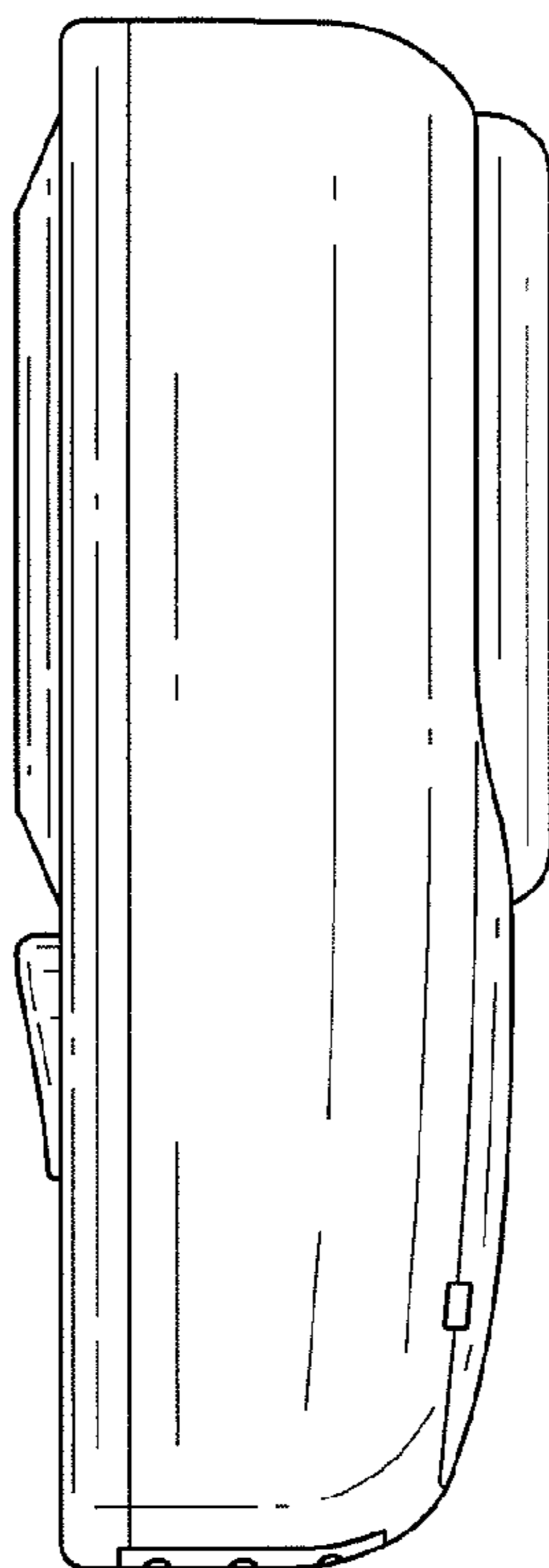

FIG. 5



FIG. 6

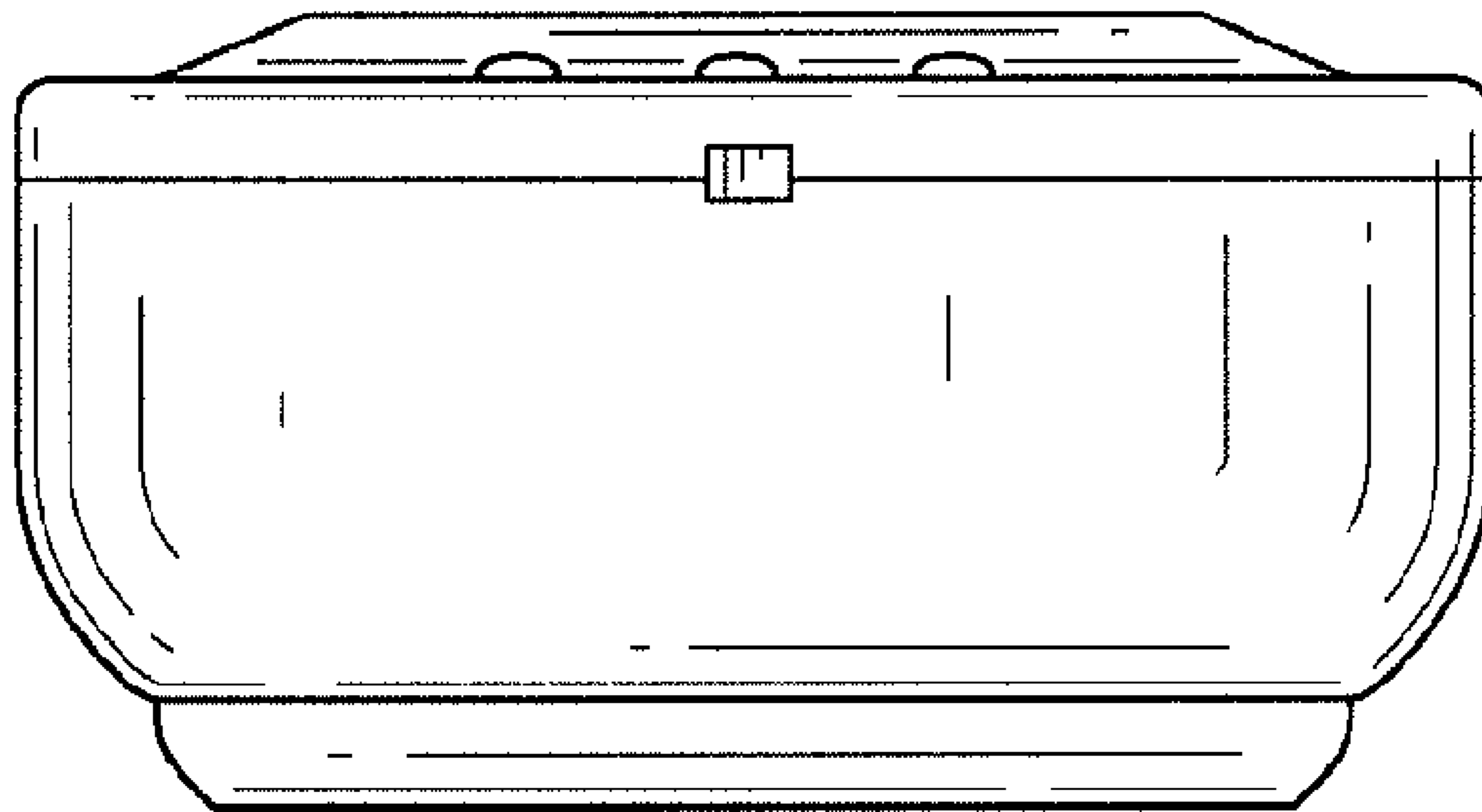

FIG. 7