



US00D596231S

(12) **United States Design Patent**
Hung

(10) **Patent No.:** **US D596,231 S**

(45) **Date of Patent:** **** Jul. 14, 2009**

(54) **MARKER**

(75) Inventor: **Peter M. H. Hung**, Kowloon (HK)

(73) Assignee: **Fulon Development Limited**, Kowloon (HK)

(**) Term: **14 Years**

(21) Appl. No.: **29/324,889**

(22) Filed: **Sep. 23, 2008**

(51) **LOC (9) Cl.** **19-06**

(52) **U.S. Cl.** **D19/43**

(58) **Field of Classification Search** D11/2,
D11/6, 7, 14, 79; D19/35, 36, 41, 42, 43,
D19/44, 45, 46, 47, 48, 49, 50, 51, 54, 55,
D19/56, 57; D27/146; 24/11 F, 11 P, 11 R;
401/6, 52, 99, 100, 104, 105, 106, 107, 108,
401/109, 192, 195; 708/107

See application file for complete search history.

(56) **References Cited**

U.S. PATENT DOCUMENTS

- D45,270 S * 2/1914 Osterberg D27/195
- D67,071 S * 4/1925 Camfield D11/79
- D153,409 S * 4/1949 Weinreich D11/2
- D202,843 S * 11/1965 Dales D3/208
- D277,559 S * 2/1985 Mackie D11/6

- D420,572 S * 2/2000 Warner D9/600
- D431,455 S * 10/2000 Mansau D9/600
- D585,490 S * 1/2009 Puglisi D19/48

* cited by examiner

Primary Examiner—Elizabeth A Albert

Assistant Examiner—Karen E Eldridge Powers

(74) *Attorney, Agent, or Firm*—Rabin & Berdo, P.C.

(57) **CLAIM**

The ornamental design for a marker, as shown and described.

DESCRIPTION

FIG. 1 is a front perspective view of a marker showing my new design;

FIG. 2 is a front perspective view with cap separated thereof;

FIG. 3 is a front view thereof;

FIG. 4 is a left side view thereof;

FIG. 5 is a top view thereof;

FIG. 6 is a right side view thereof;

FIG. 7 is a rear view thereof; and,

FIG. 8 is a bottom view thereof.

The broken lines illustrating a beaded ring in the drawings are environmental matter and form no part of the claimed design.

1 Claim, 3 Drawing Sheets

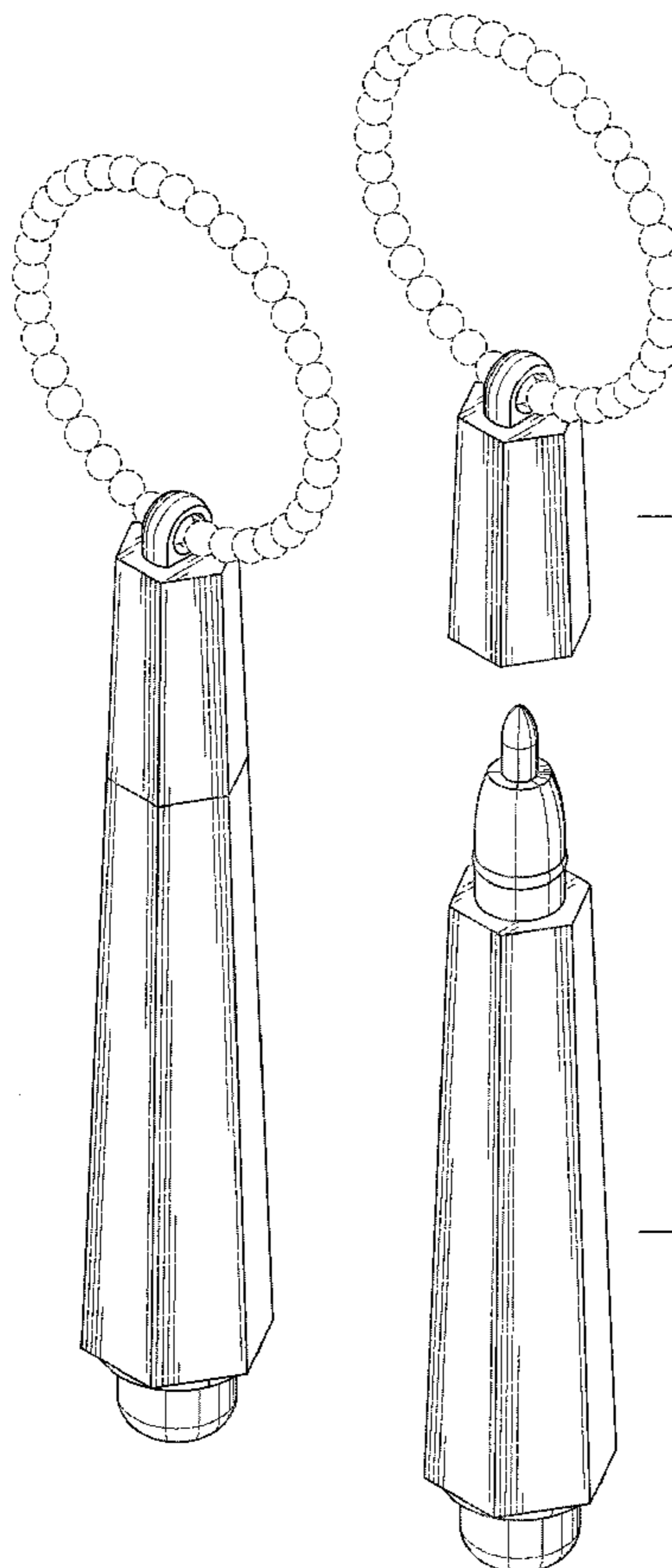

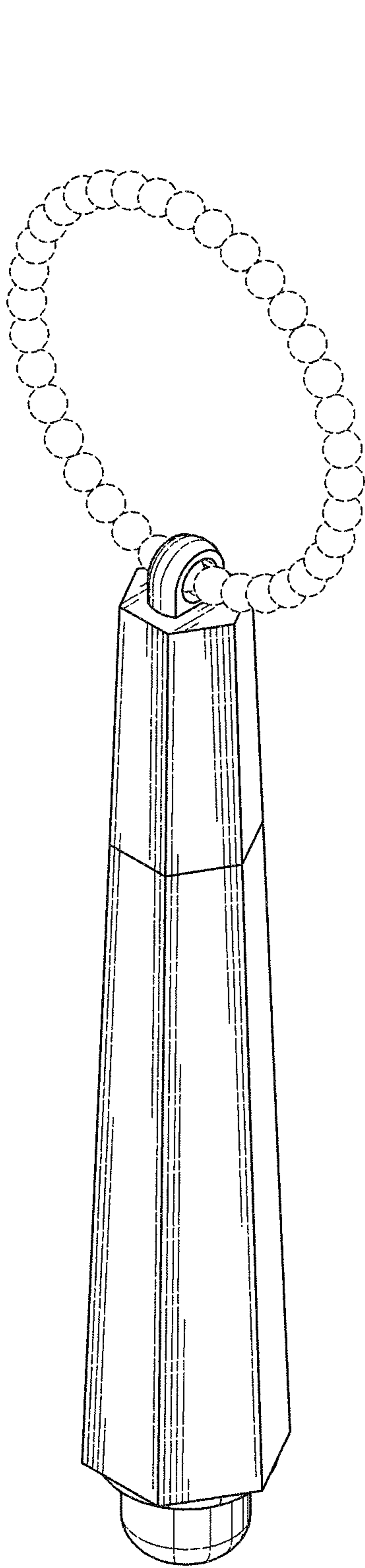

FIG. 1

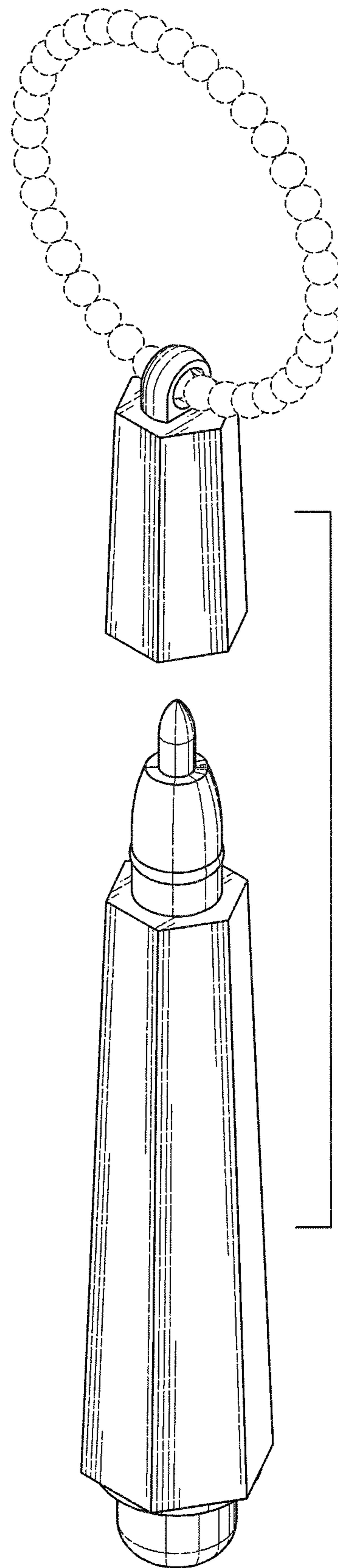

FIG. 2

FIG. 5

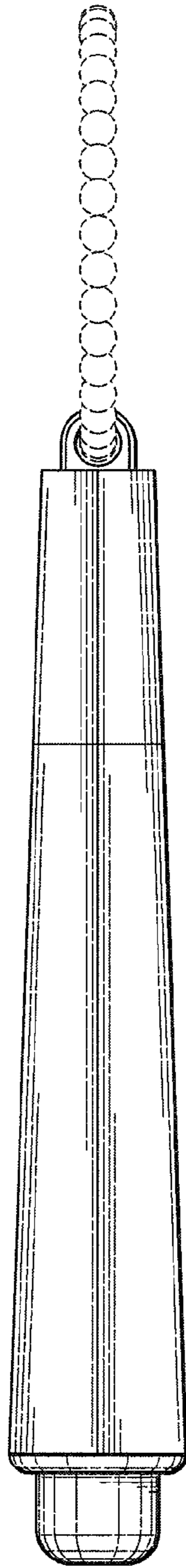
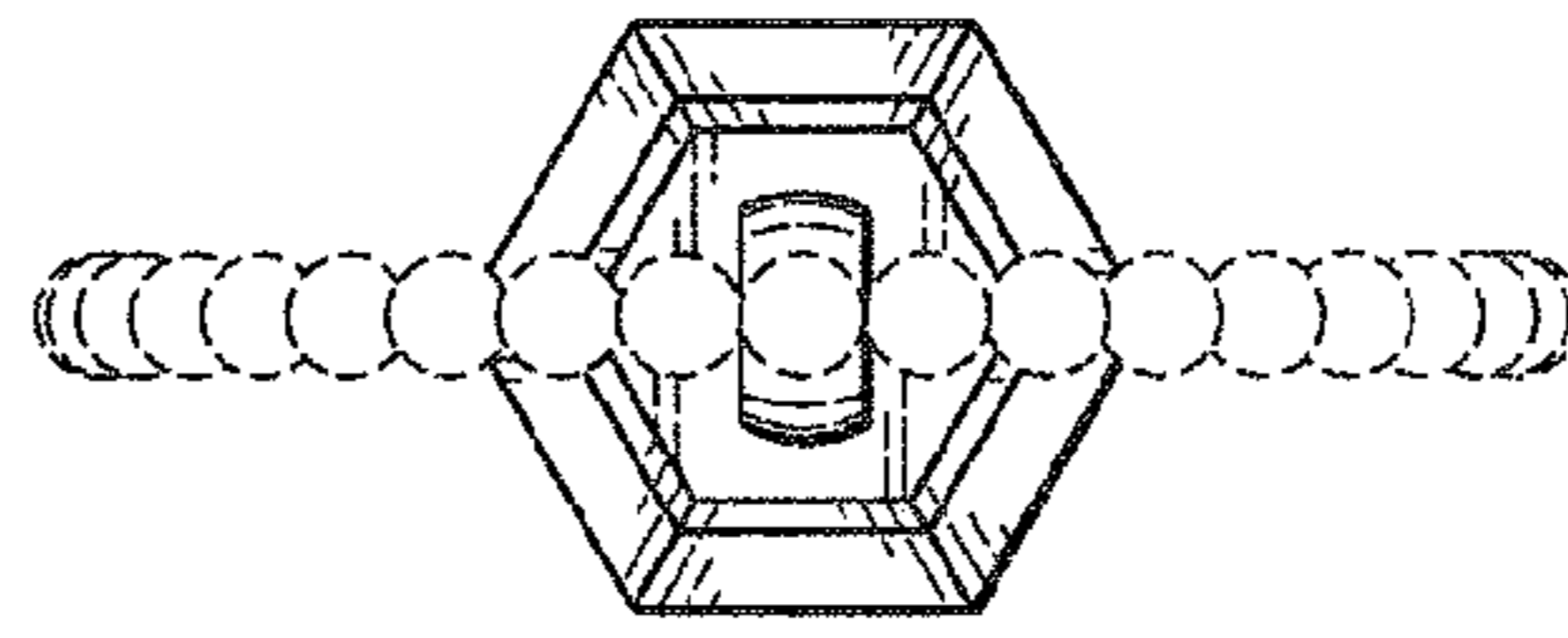

FIG. 4

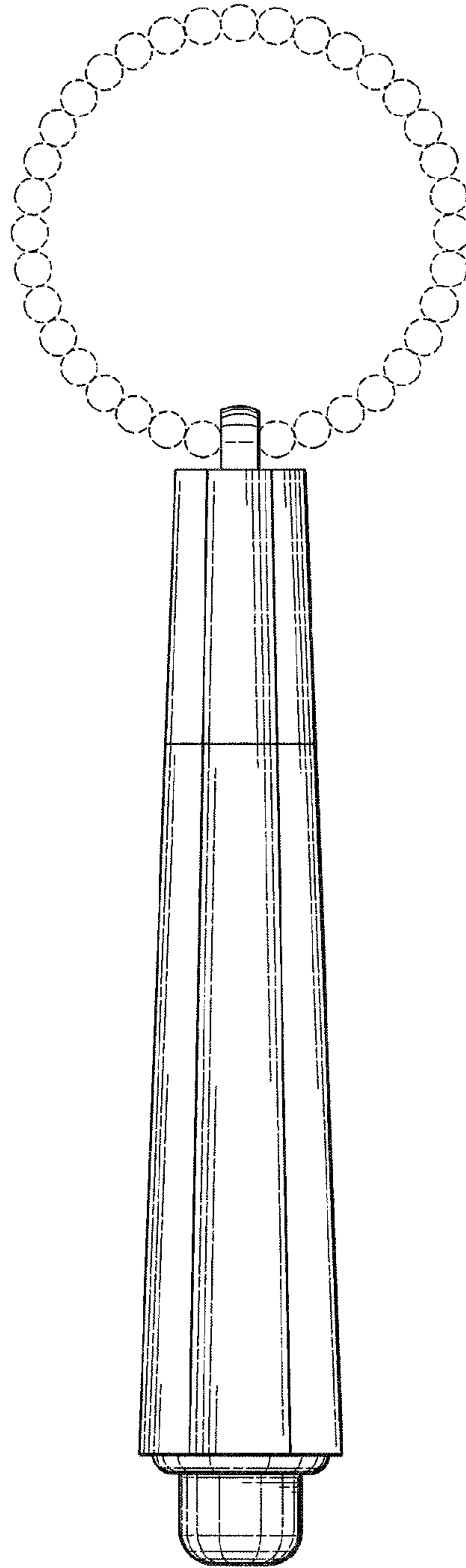

FIG. 3

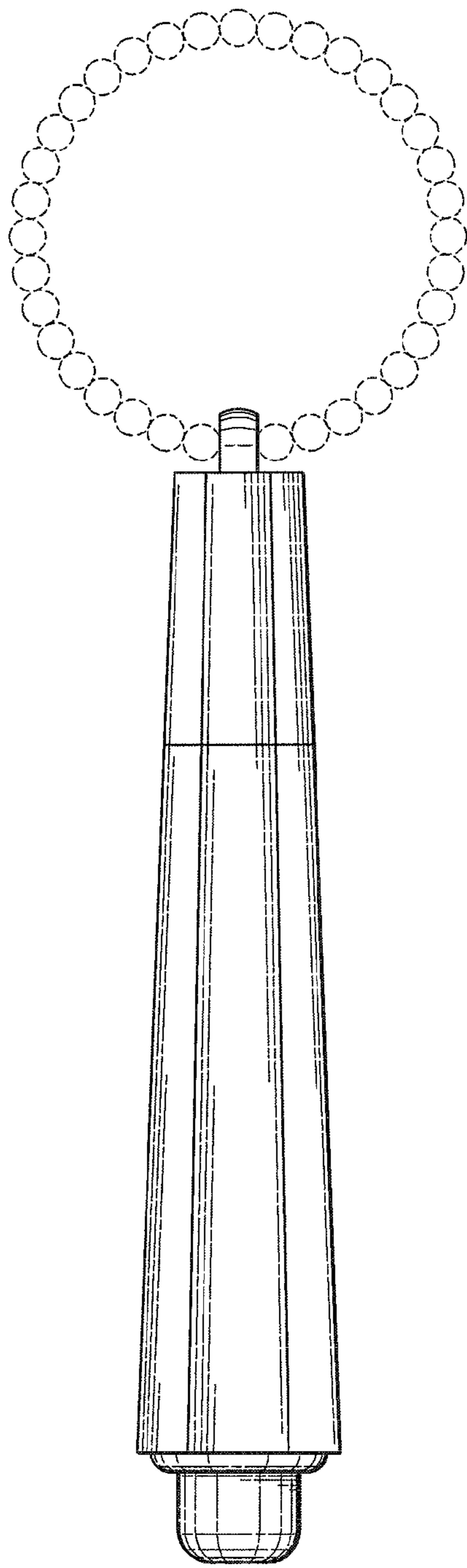

FIG. 7

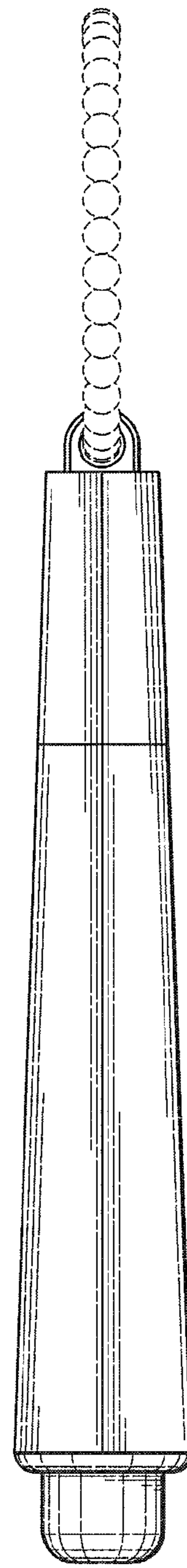

FIG. 6

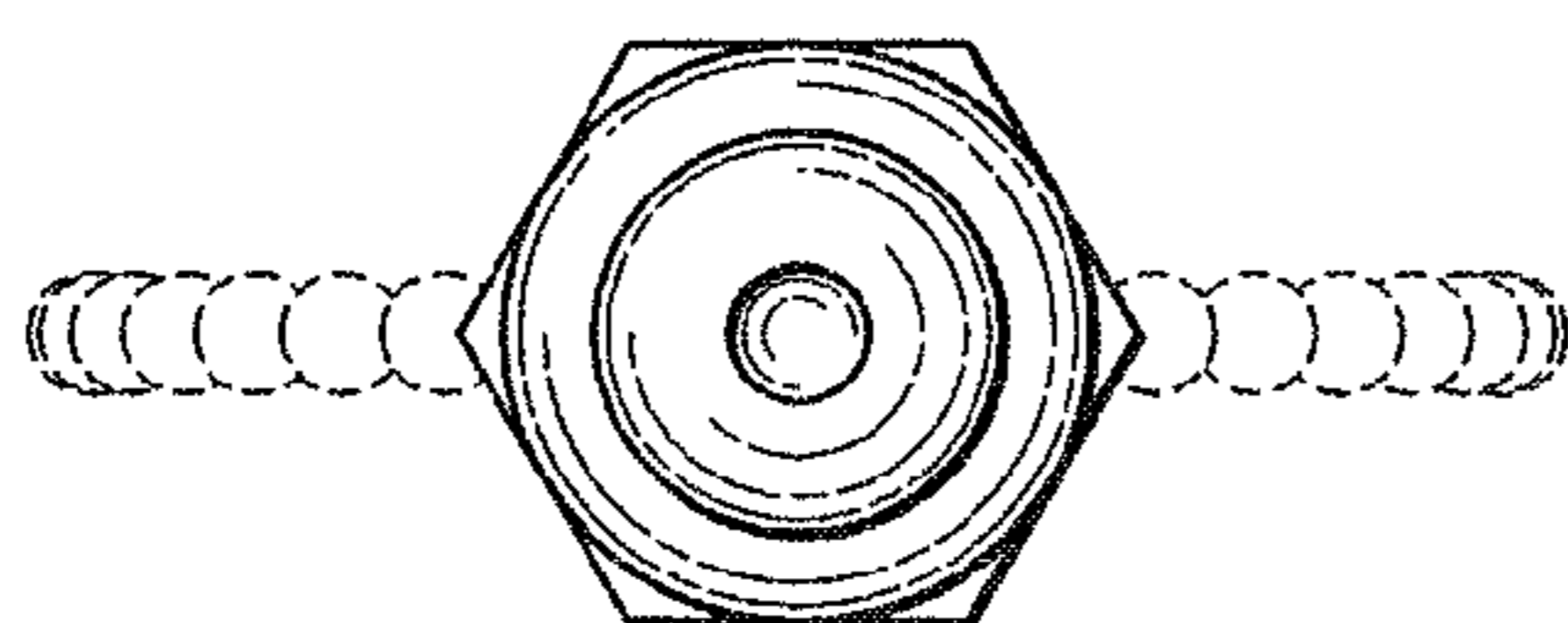

FIG. 8