



US00D596136S

(12) **United States Design Patent**  
**Sakamoto**

(10) **Patent No.:** **US D596,136 S**  
(45) **Date of Patent:** **\*\* Jul. 14, 2009**

(54) **ELECTRICAL CONTACT**

(75) Inventor: **Tetsuma Sakamoto**, Tokyo (JP)

(73) Assignee: **Tyco Electronics AMP K.K.**,  
Kanagawa-Ken (JP)

(\*\*) Term: **14 Years**

(21) Appl. No.: **29/327,907**

(22) Filed: **Nov. 14, 2008**

(30) **Foreign Application Priority Data**

May 16, 2008 (JP) ..... 2008-012220

(51) **LOC (9) Cl.** ..... **13-03**

(52) **U.S. Cl.** ..... **D13/154**

(58) **Field of Classification Search** ..... D13/133,  
D13/146-147, 154, 184; 439/578, 625, 675,  
439/668-669, 732, 844, 851-852, 865-867,  
439/872, 877, 884

See application file for complete search history.

(56) **References Cited**

**U.S. PATENT DOCUMENTS**

D372,222 S \* 7/1996 Matthews ..... D13/154  
5,542,861 A \* 8/1996 Anhalt et al. .... 439/578  
D501,649 S \* 2/2005 Yang et al. .... D13/133  
D566,653 S \* 4/2008 Sakamoto ..... D13/133  
2002/0058442 A1 \* 5/2002 Walker ..... 439/625

**FOREIGN PATENT DOCUMENTS**

JP 968560 11/1996  
JP D1093167 12/2000  
JP D1242037 6/2005  
JP D1251048 9/2005  
JP D1269829 5/2006

\* cited by examiner

*Primary Examiner*—Daniel D Bui

(74) *Attorney, Agent, or Firm*—Barley Snyder LLC

(57) **CLAIM**

The ornamental design for an electrical contact, as shown and described.

**DESCRIPTION**

FIG. 1 is a front elevation view of an electrical contact, showing my new design;

FIG. 2 is a top plan view thereof;

FIG. 3 is a bottom plan view thereof;

FIG. 4 is a right side elevation view thereof;

FIG. 5 is a rear elevation view thereof;

FIG. 6 is a cross sectional view thereof; taken along line 6—6 in FIG. 1 thereof;

FIG. 7 is a top, front and left side perspective view thereof; and,

FIG. 8 is a top, rear and left side perspective view thereof.

**1 Claim, 8 Drawing Sheets**

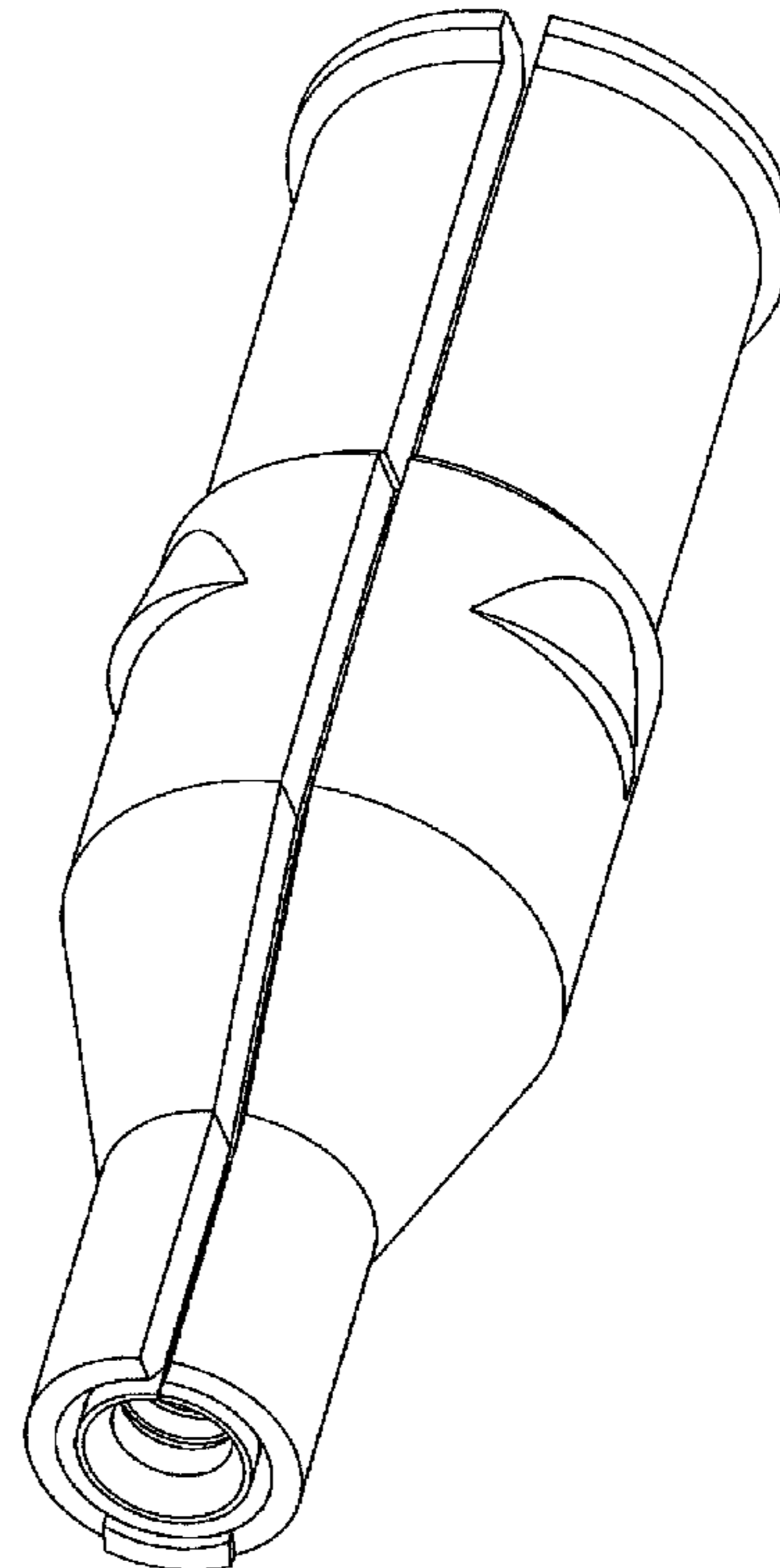
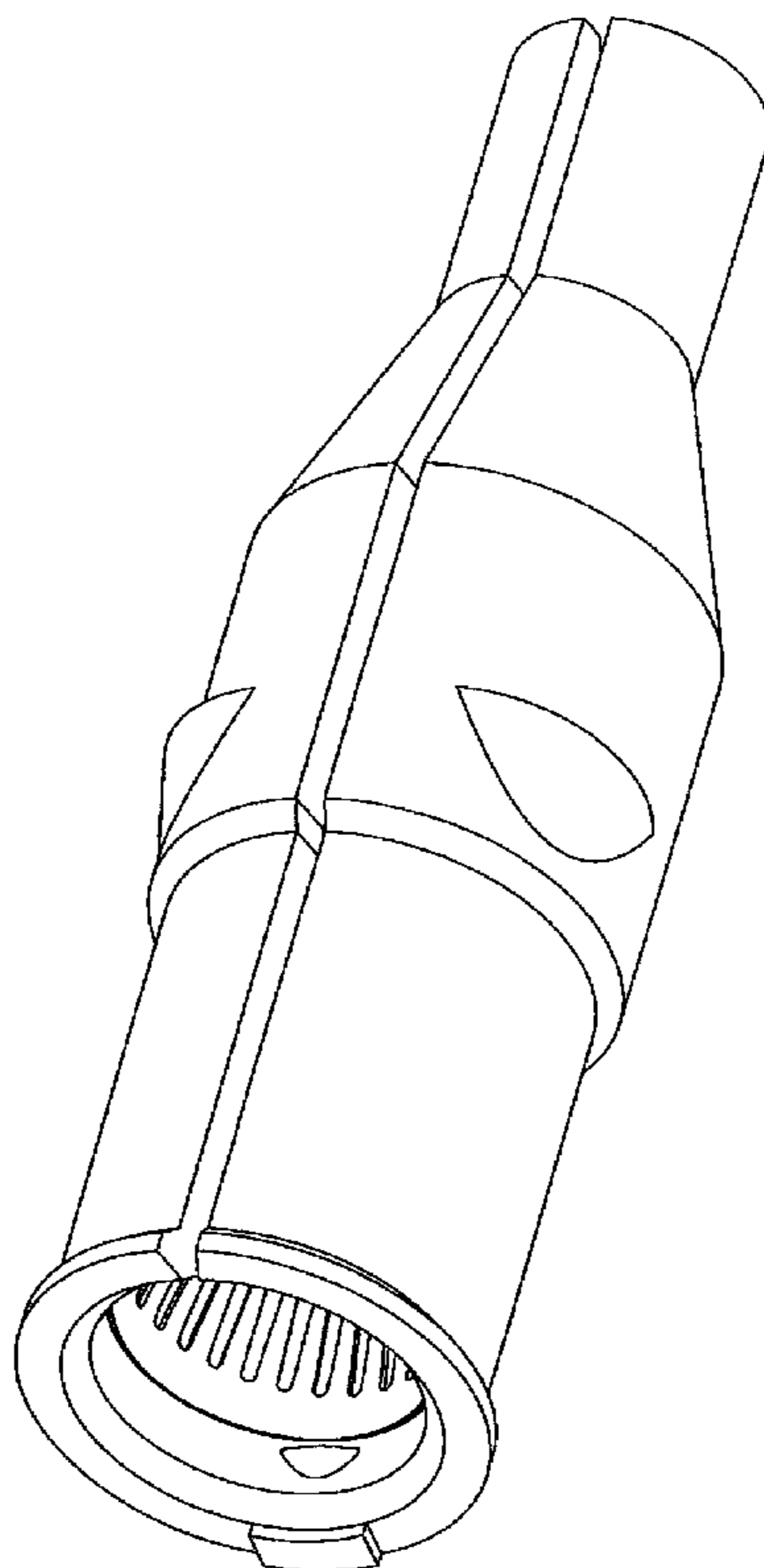

Figure 1

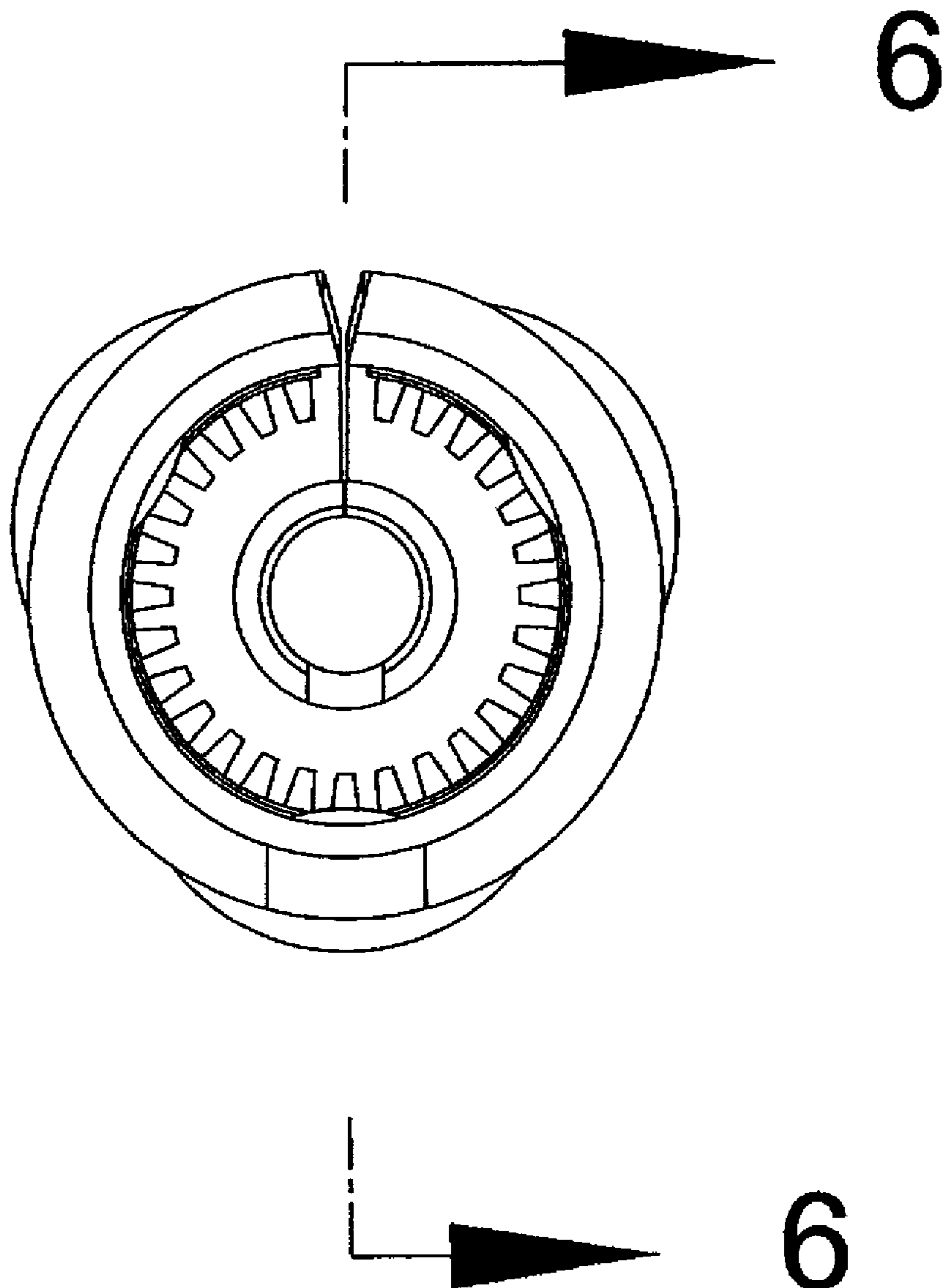

Figure 2

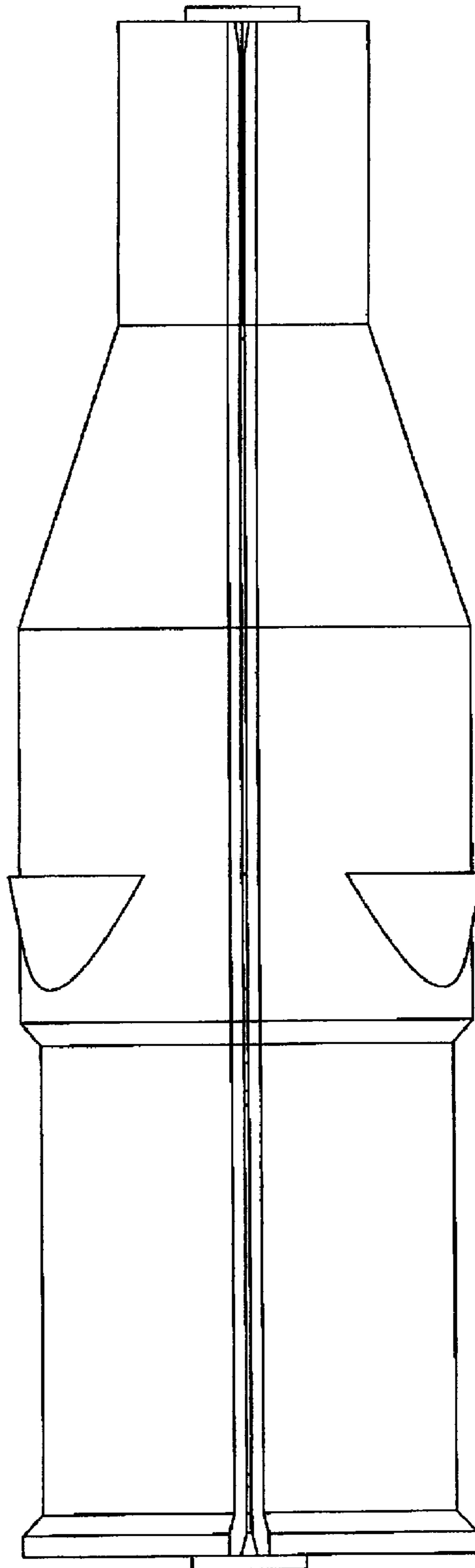

Figure 3

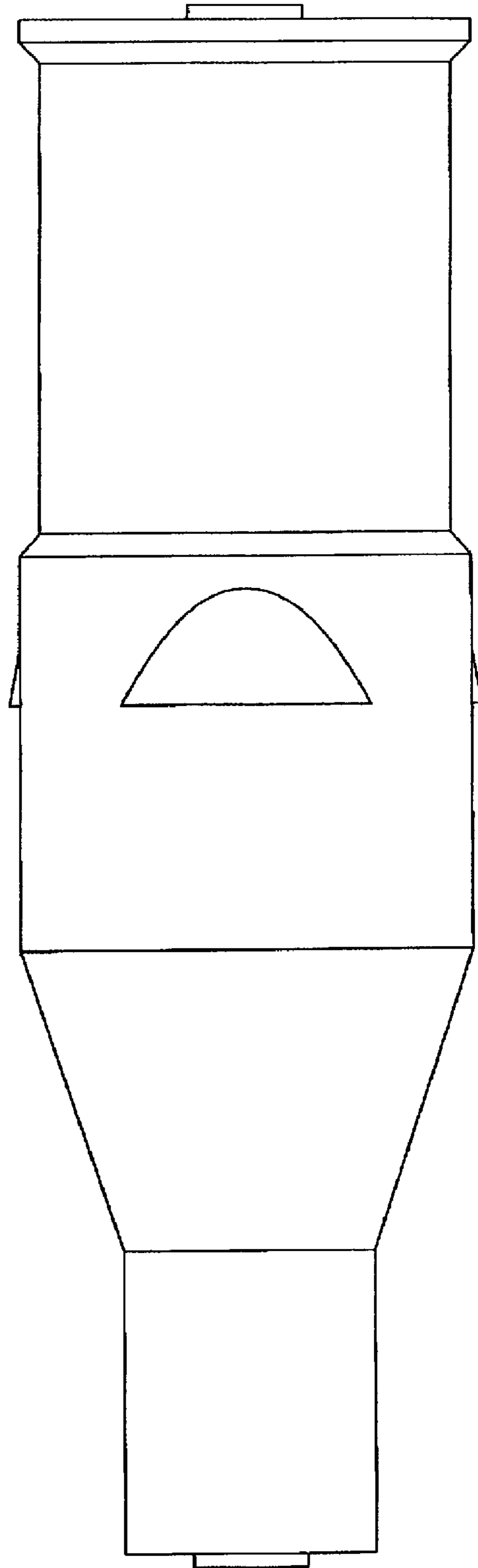

Figure 4

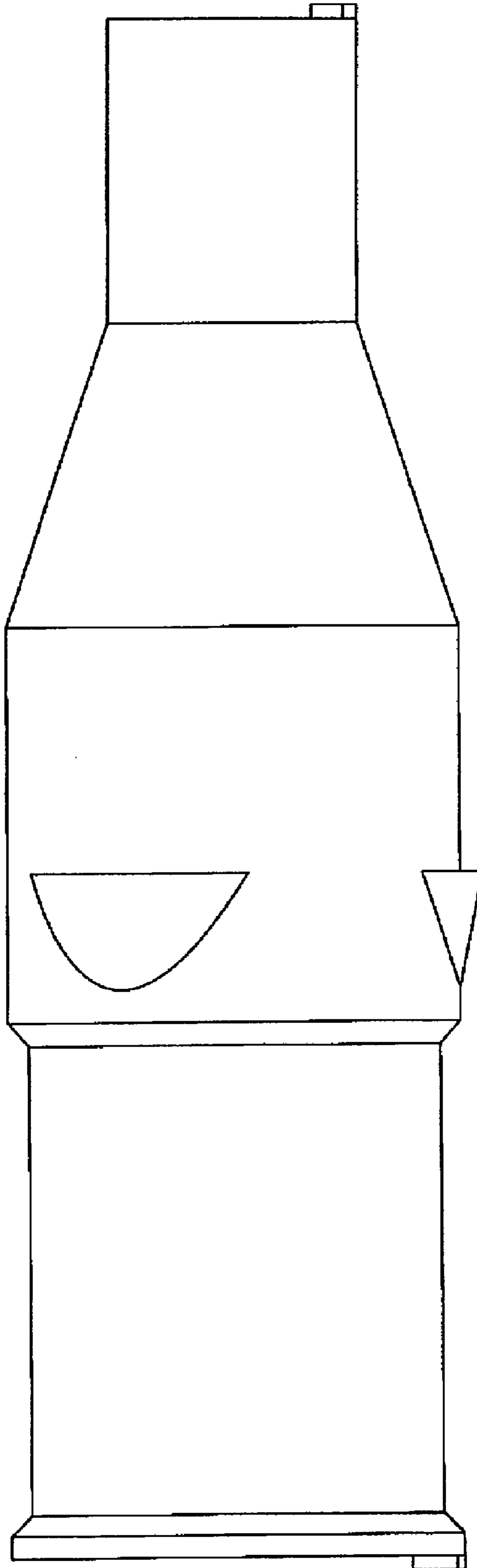
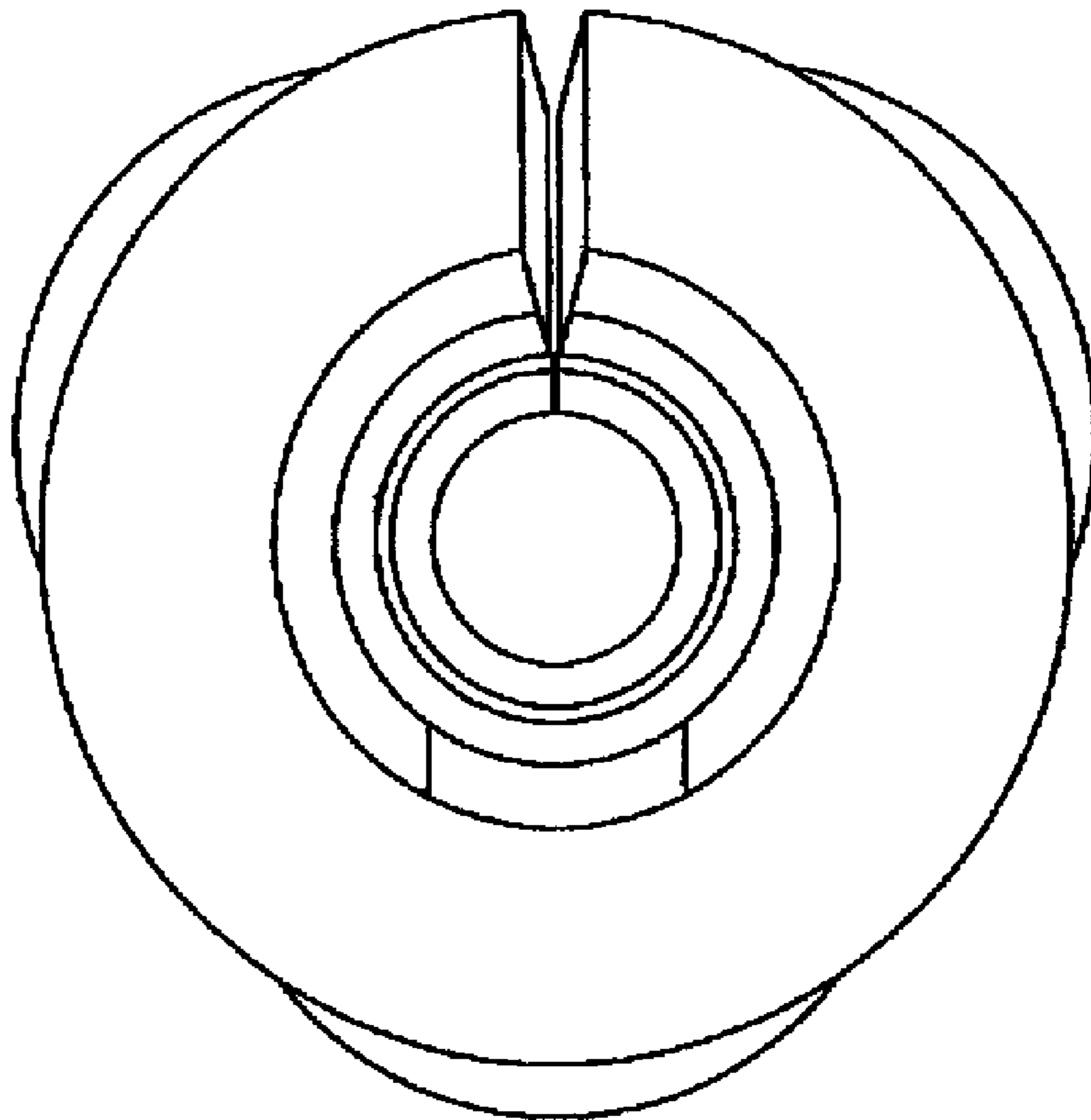

Figure 5



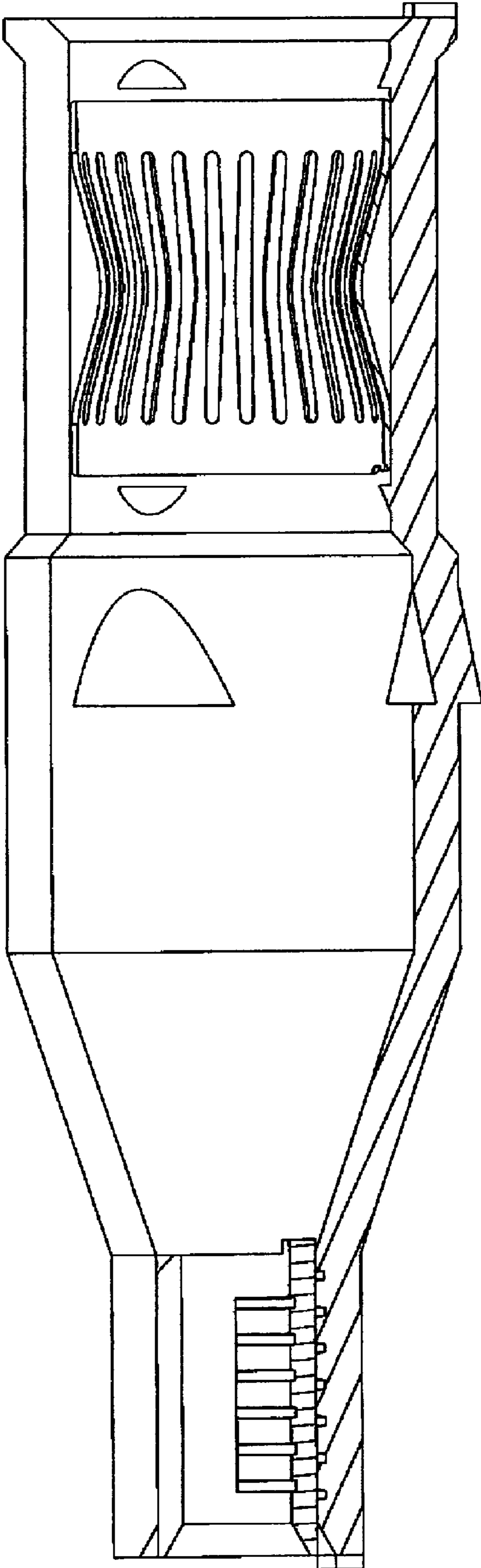
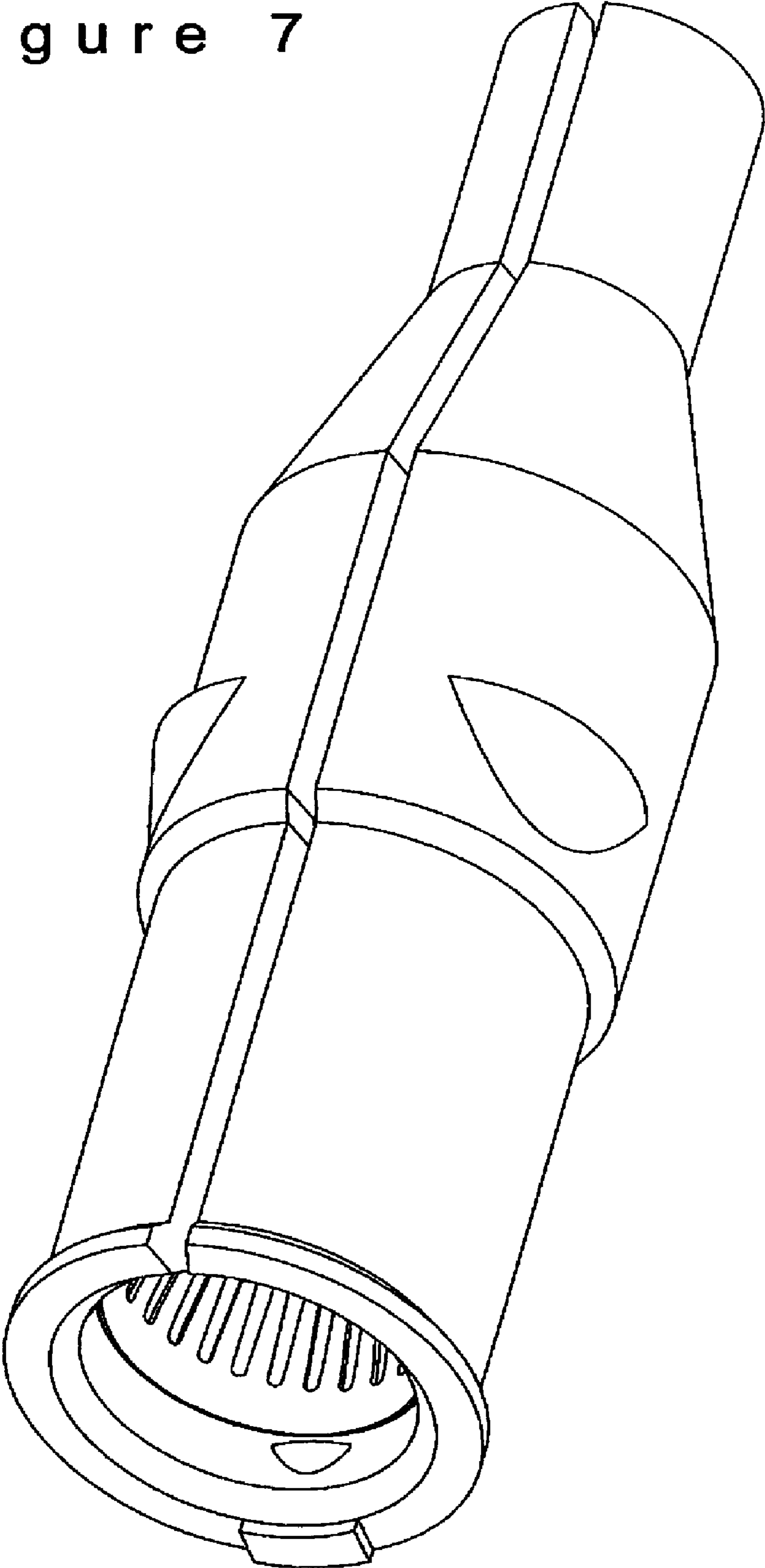

Figure 6

Figure 7





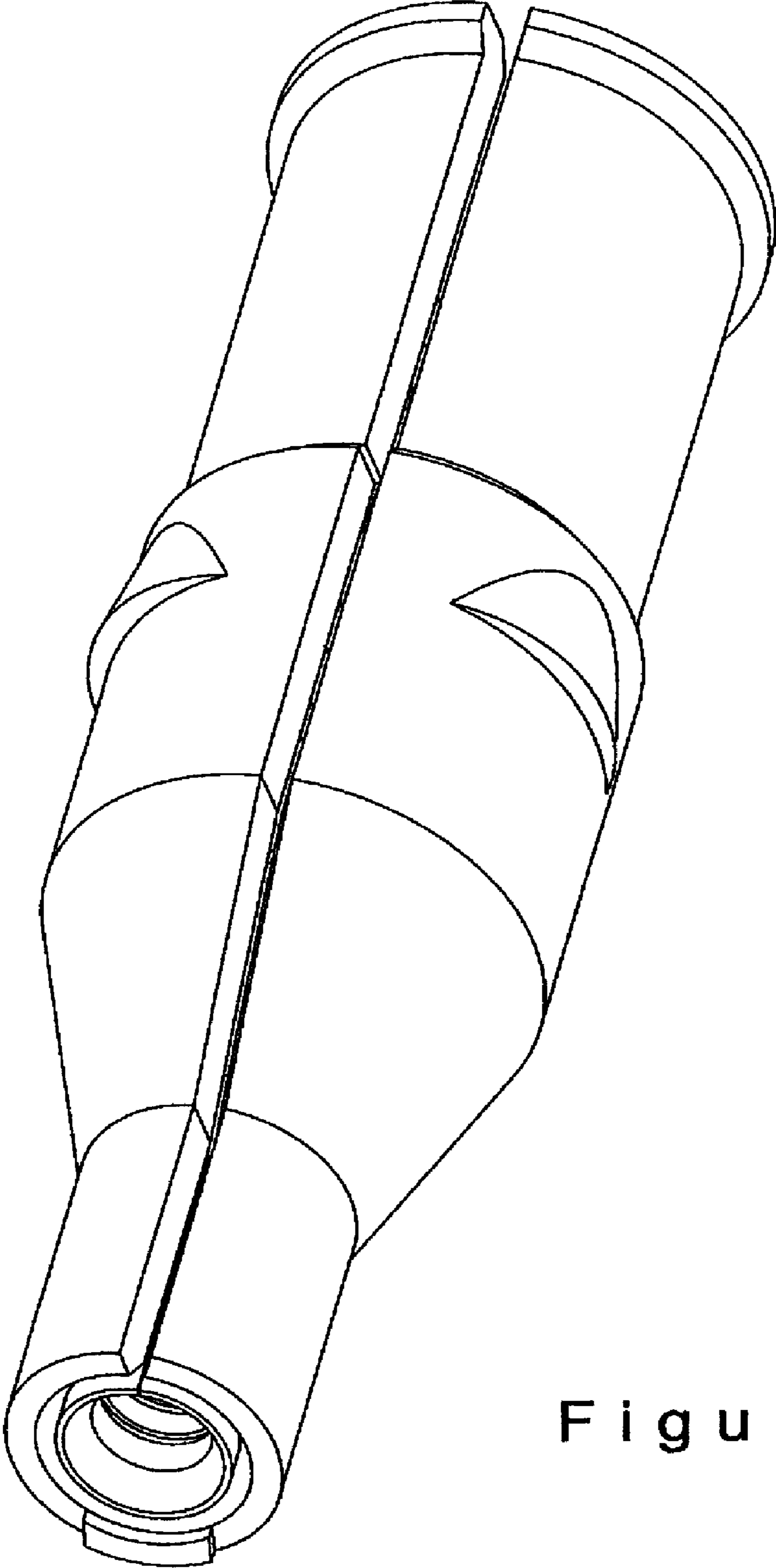

Figure 8