

US00D596128S

(12) **United States Design Patent**
Hung et al.

(10) **Patent No.:** **US D596,128 S**
(45) **Date of Patent:** **** Jul. 14, 2009**

(54) **MEMORY CARD CONNECTOR**

Primary Examiner—Daniel D Bui
(74) *Attorney, Agent, or Firm*—Rosenberg, Klein & Lee

(75) Inventors: **Pei-Chiao Hung**, Tu-Cheng (TW); **Hsin Tsung Ho**, Tu-Cheng (TW)

(73) Assignee: **Cheng Uei Precision Industry Co., Ltd.**, Taipei Hsien (TW)

(57) **CLAIM**

The ornamental design for a memory card connector, as shown and described.

(**) Term: **14 Years**

(21) Appl. No.: **29/309,041**

DESCRIPTION

(22) Filed: **Jun. 13, 2008**

(51) **LOC (9) Cl.** **13-03**

(52) **U.S. Cl.** **D13/147**

(58) **Field of Classification Search** D13/147,
D13/154, 184; D14/432, 433, 436, 438;
361/684–685; 439/64, 79, 159–160, 330–331,
439/341–342, 607–610, 629–630, 660, 946
See application file for complete search history.

FIG. 1 is a perspective view of a memory card connector showing our new design;

FIG. 2 is a front elevational view thereof;

FIG. 3 is a rear elevational view thereof;

FIG. 4 is a left side elevational view thereof;

FIG. 5 is a right side elevational view thereof;

FIG. 6 is a top plan view thereof;

FIG. 7 is a bottom plan view thereof;

FIG. 8 is another perspective view of the memory card connector showing our new design; and,

FIG. 9 is a perspective view showing the memory card connector in a using state.

The broken line portions of the figure drawings are included to show unclaimed subject matter only and forms no part of the claimed design.

(56) **References Cited**

U.S. PATENT DOCUMENTS

D520,957 S *	5/2006	Chang et al.	D13/147
D544,842 S *	6/2007	Nishio et al.	D13/147
D550,629 S *	9/2007	Kagami	D13/147
D559,787 S *	1/2008	Sasaki et al.	D13/147
D566,655 S *	4/2008	Chen et al.	D13/147
D568,250 S *	5/2008	Wu et al.	D13/147
D570,291 S *	6/2008	Zhang	D13/147

* cited by examiner

1 Claim, 9 Drawing Sheets

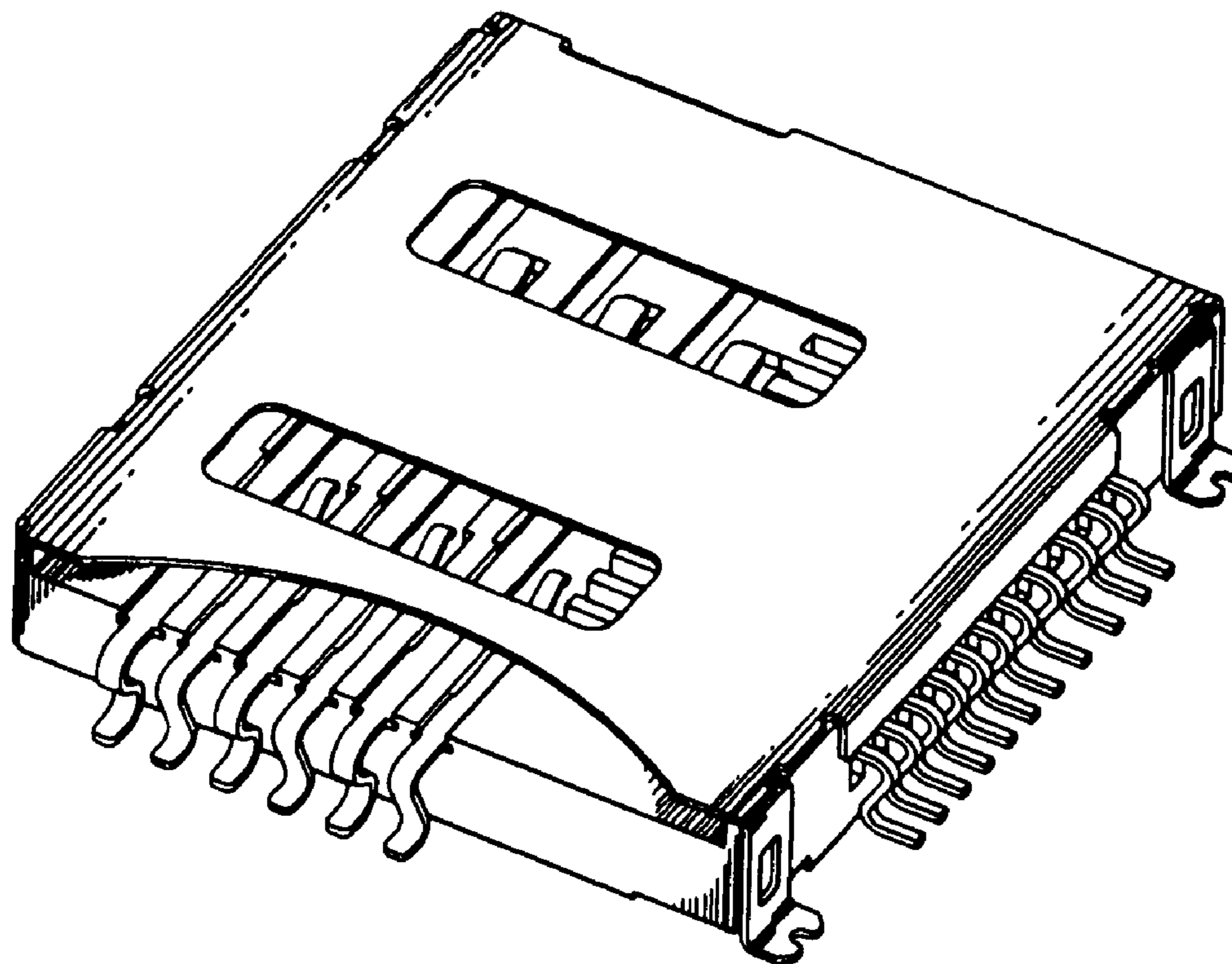

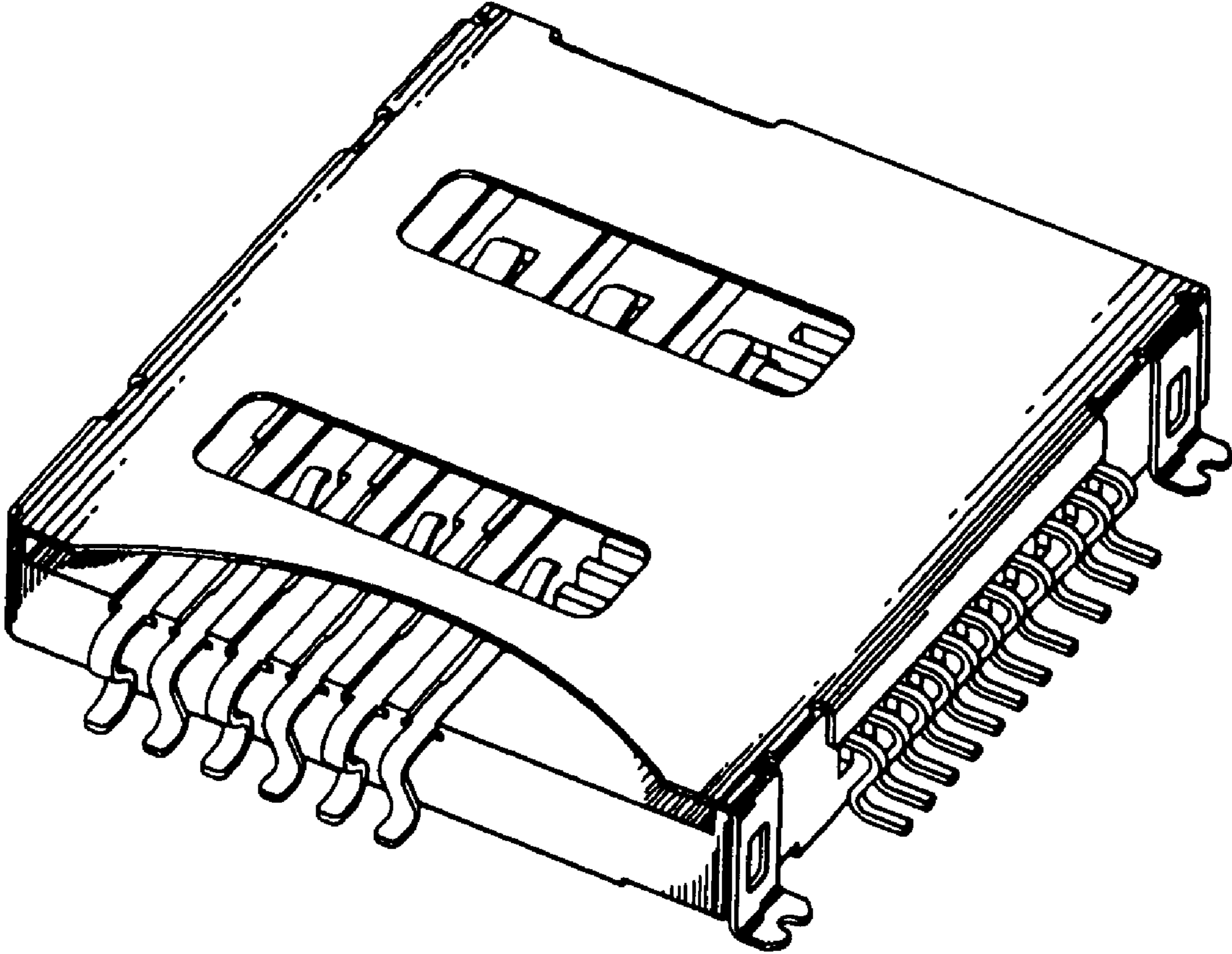

FIG. 1

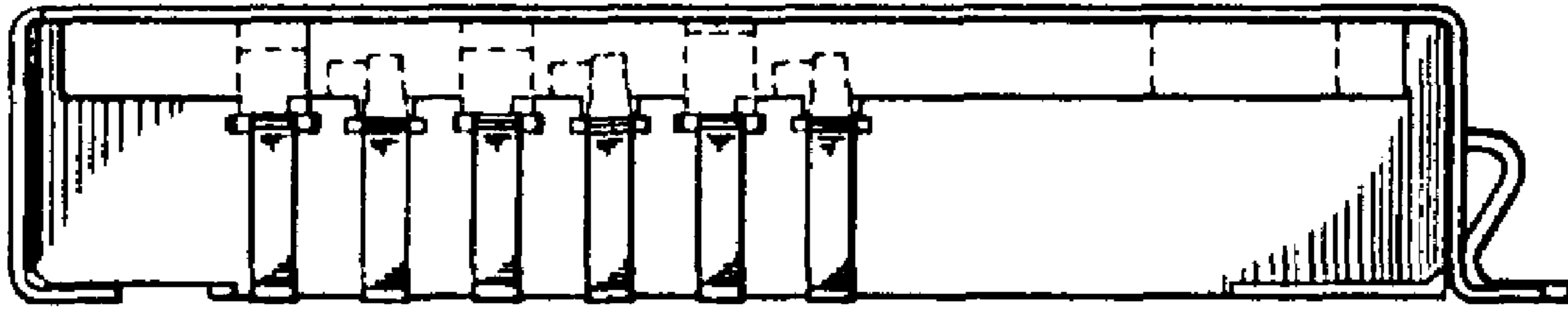

FIG. 2



FIG. 3

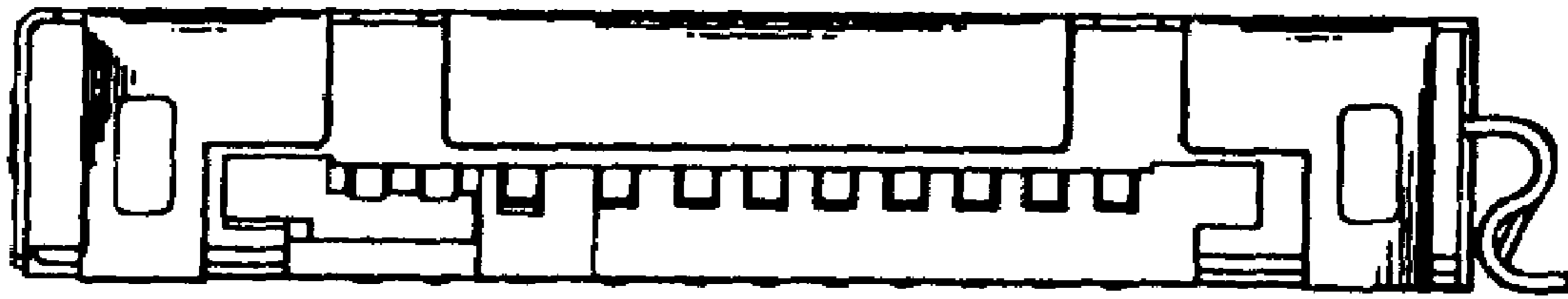

FIG. 4

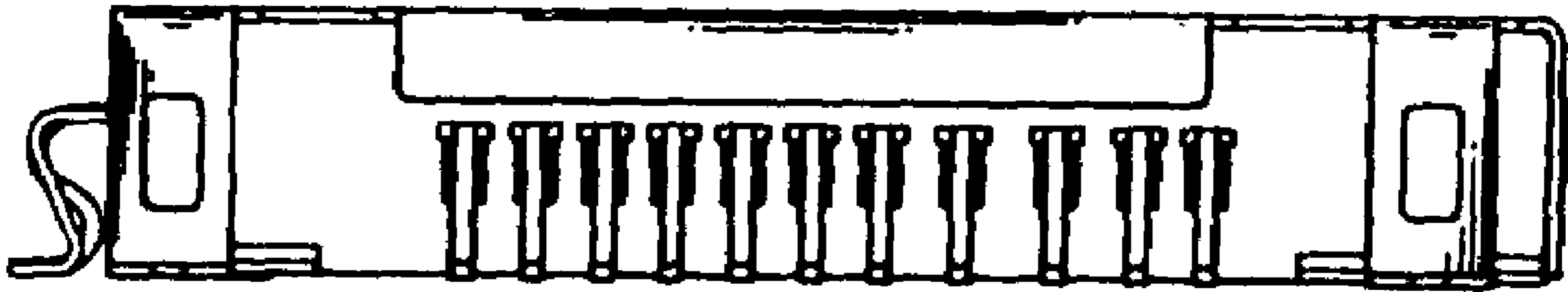

FIG. 5

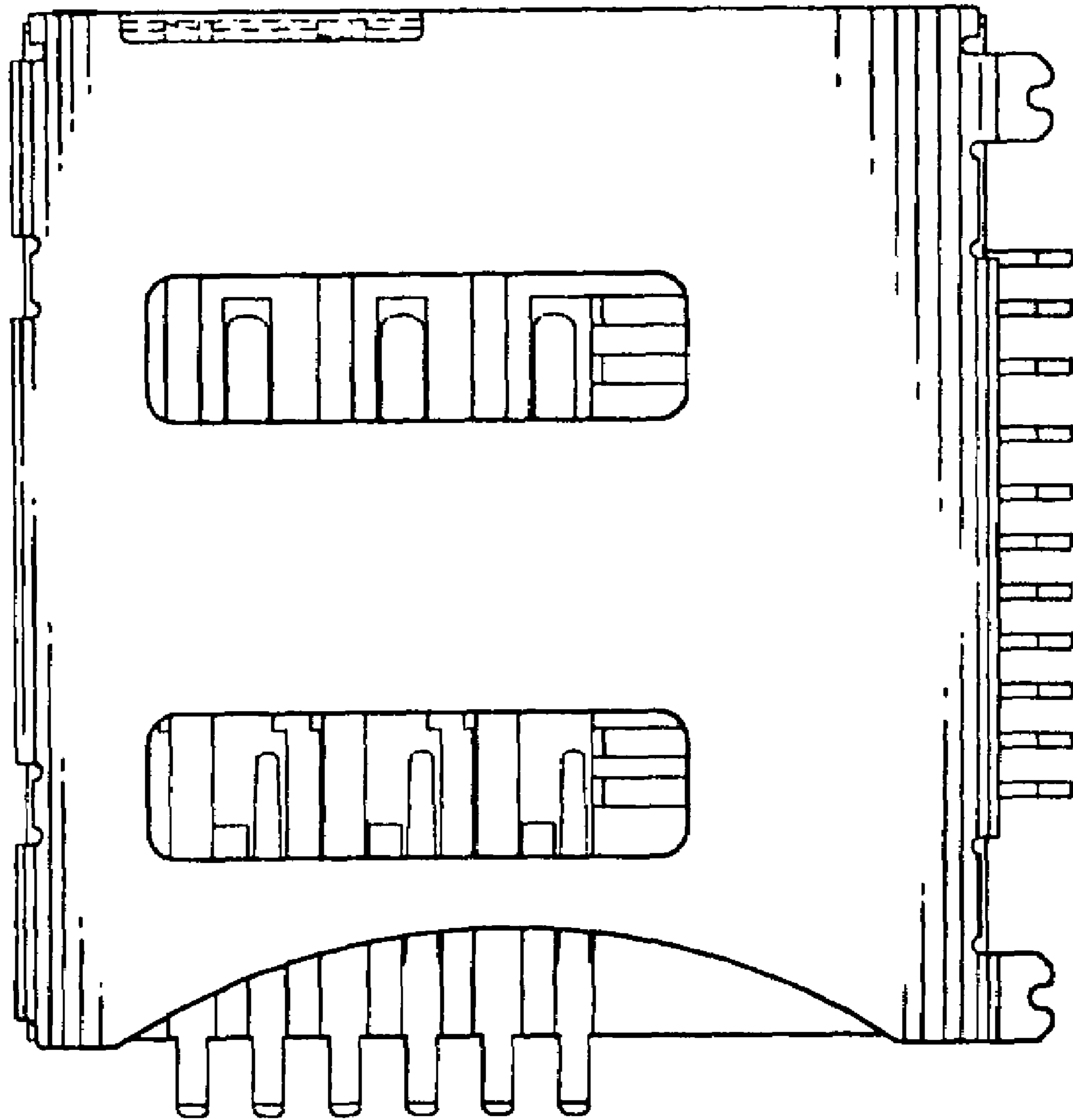

FIG. 6

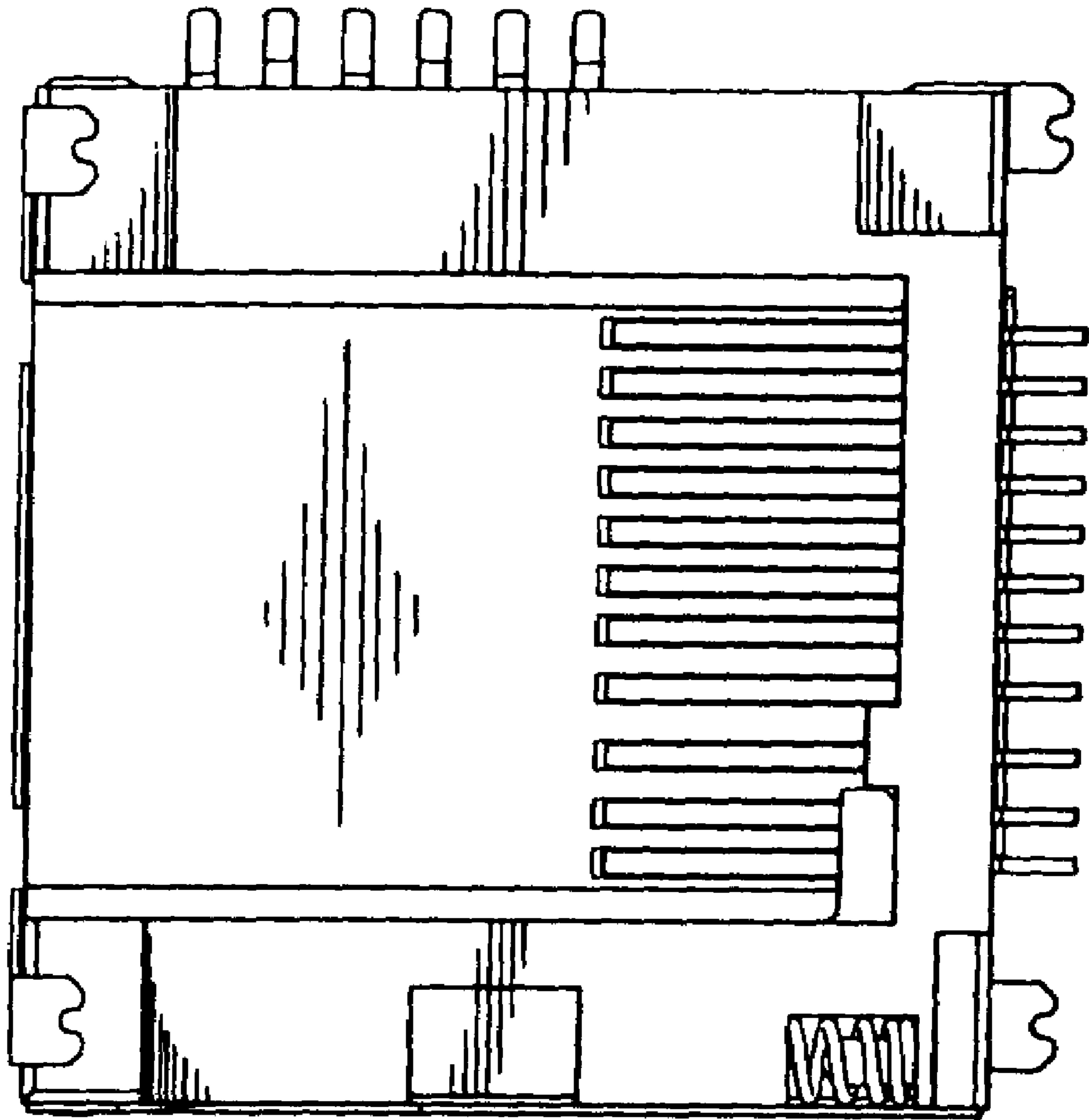

FIG. 7

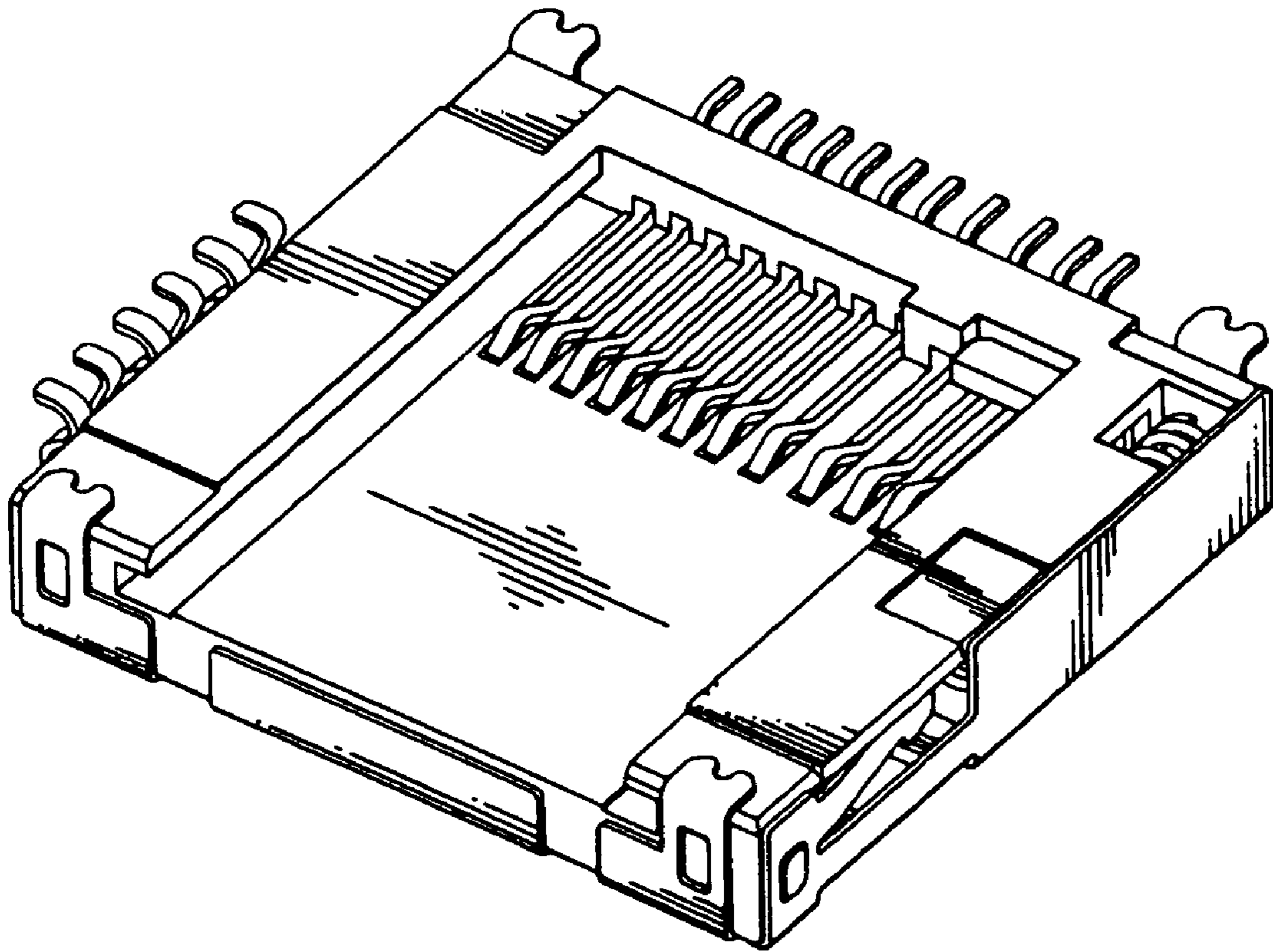

FIG. 8

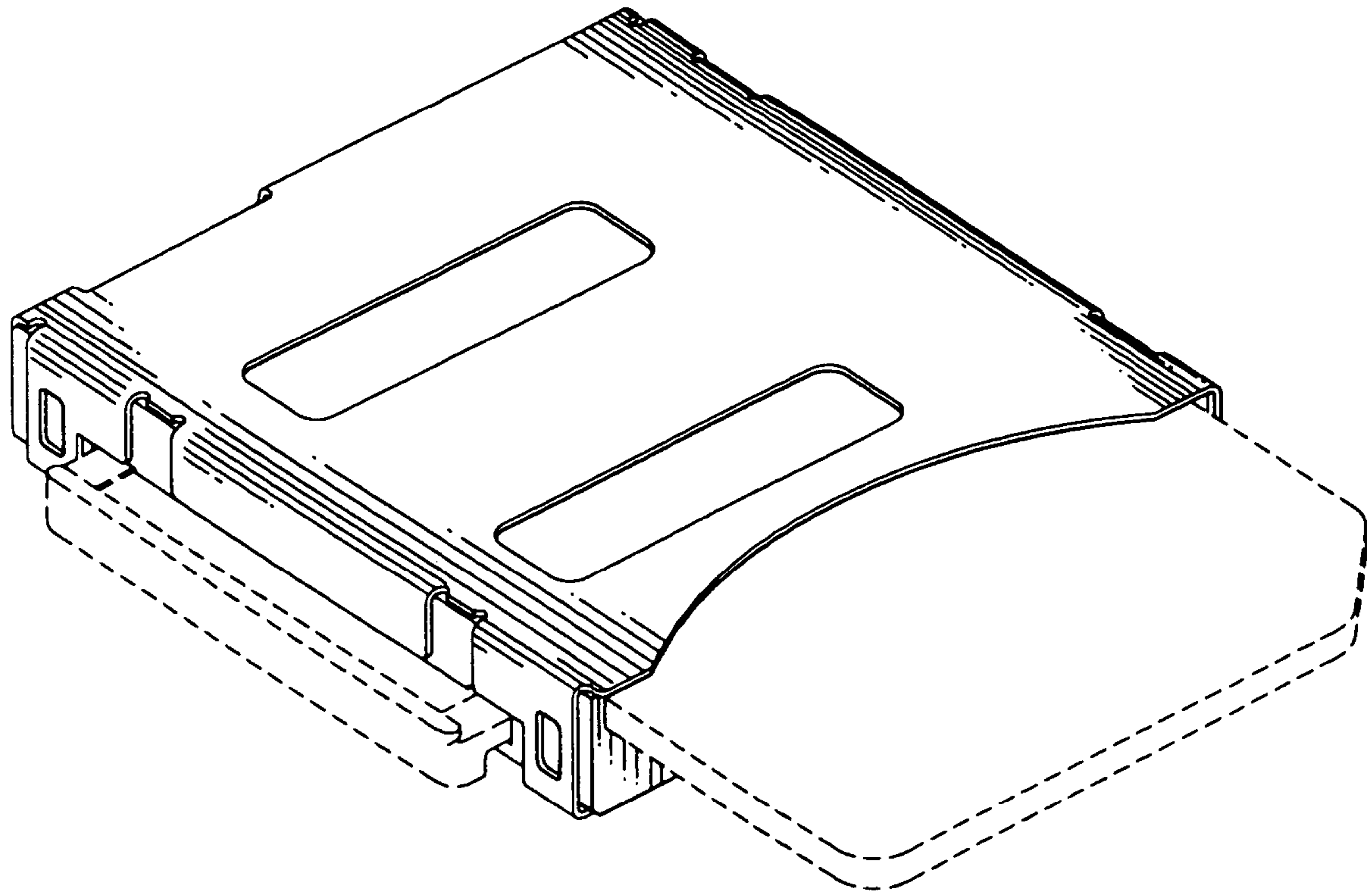

FIG. 9