



US00D596047S

(12) **United States Design Patent**
Wonderley

(10) **Patent No.:** **US D596,047 S**
(45) **Date of Patent:** **** Jul. 14, 2009**

- (54) **RAZOR DISPENSER**
- (75) Inventor: **Jeffrey W. Wonderley**, Fort Defiance, VA (US)
- (73) Assignee: **American Safety Razor**, Verona, VA (US)
- (**) Term: **14 Years**
- (21) Appl. No.: **29/300,867**
- (22) Filed: **May 22, 2008**
- (51) **LOC (9) Cl.** **09-03**
- (52) **U.S. Cl.** **D9/749; D9/736**
- (58) **Field of Classification Search** D9/424, D9/432, 425, 748, 749, 730, 737, 735, 736; 30/526, 47, 40, 38, 536, 537, 40.2, 50, 541; 206/356, 511, 208, 228, 352, 354, 366, 564, 206/557; 220/669, 675, 555, 556
See application file for complete search history.

7,040,024	B2	5/2006	Lukan et al.	
D531,518	S *	11/2006	Ramm et al. D9/749
7,159,324	B2	1/2007	Worrick, III	
2002/0184770	A1	12/2002	Peysner	
2005/0198825	A1	9/2005	Apprille, Jr.	
2007/0007155	A1	1/2007	Foster	

FOREIGN PATENT DOCUMENTS

DE	2 437 358	10/2007
EP	1 577 228 A1	9/2005
GB	2 245 859	1/1992
JP	64-22204	1/1989
JP	64-83206	3/1989
JP	07-222619	8/1995
JP	07-227487	8/1995
JP	2001-002132	1/2001
JP	2001-310088	11/2001
JP	2003-24121	1/2003
JP	2006-75188	3/2006
JP	2006-232325	9/2006
WO	WO 98/36879	8/1998

* cited by examiner

(56) **References Cited**

U.S. PATENT DOCUMENTS

D231,198	S *	4/1974	Casseli et al.	D9/736
3,854,201	A *	12/1974	Dawidowicz et al.	30/40.2
D256,997	S *	9/1980	Motta	D9/736
D256,998	S *	9/1980	Motta	D9/736
D312,568	S *	12/1990	Gray	D9/736
D313,175	S	12/1990	Motta		
D324,299	S *	3/1992	Bowman	D9/736
D358,761	S *	5/1995	Ho	D9/736
5,429,241	A	7/1995	Althaus		
D366,611	S *	1/1996	Poisson	D9/736
5,518,114	A *	5/1996	Kohring et al.	206/352
D397,290	S *	8/1998	Petricca et al.	D9/736
D398,523	S *	9/1998	Petricca et al.	D9/749
5,867,907	A	2/1999	Terry et al.		
5,946,805	A	9/1999	Oldroyd		
6,041,926	A	3/2000	Petricca et al.		
6,052,903	A	4/2000	Metcalf et al.		
D430,013	S *	8/2000	Shurtleff et al.	D9/749
6,192,586	B1	2/2001	Metcalf et al.		
6,237,232	B1 *	5/2001	Petricca et al.	30/526
6,415,517	B1	7/2002	Worrick, III		
6,499,595	B1	12/2002	Petricca		
6,886,690	B2	5/2005	Petricca		

Primary Examiner—Stella M Reid

Assistant Examiner—Mark A Goodwin

(74) *Attorney, Agent, or Firm*—McDermott Will & Emery LLP

(57) **CLAIM**

The ornamental design for a razor dispenser, as shown and described.

DESCRIPTION

FIG. 1 is a front perspective view of the razor dispenser, showing the new design;

FIG. 2 is a front view of the razor dispenser;

FIG. 3 is a rear view of the razor dispenser;

FIG. 4 is a side view of the razor dispenser;

FIG. 5 is another side view of the razor dispenser;

FIG. 6 is a top view of the razor dispenser; and,

FIG. 7 is a bottom view of the razor dispenser.

1 Claim, 5 Drawing Sheets

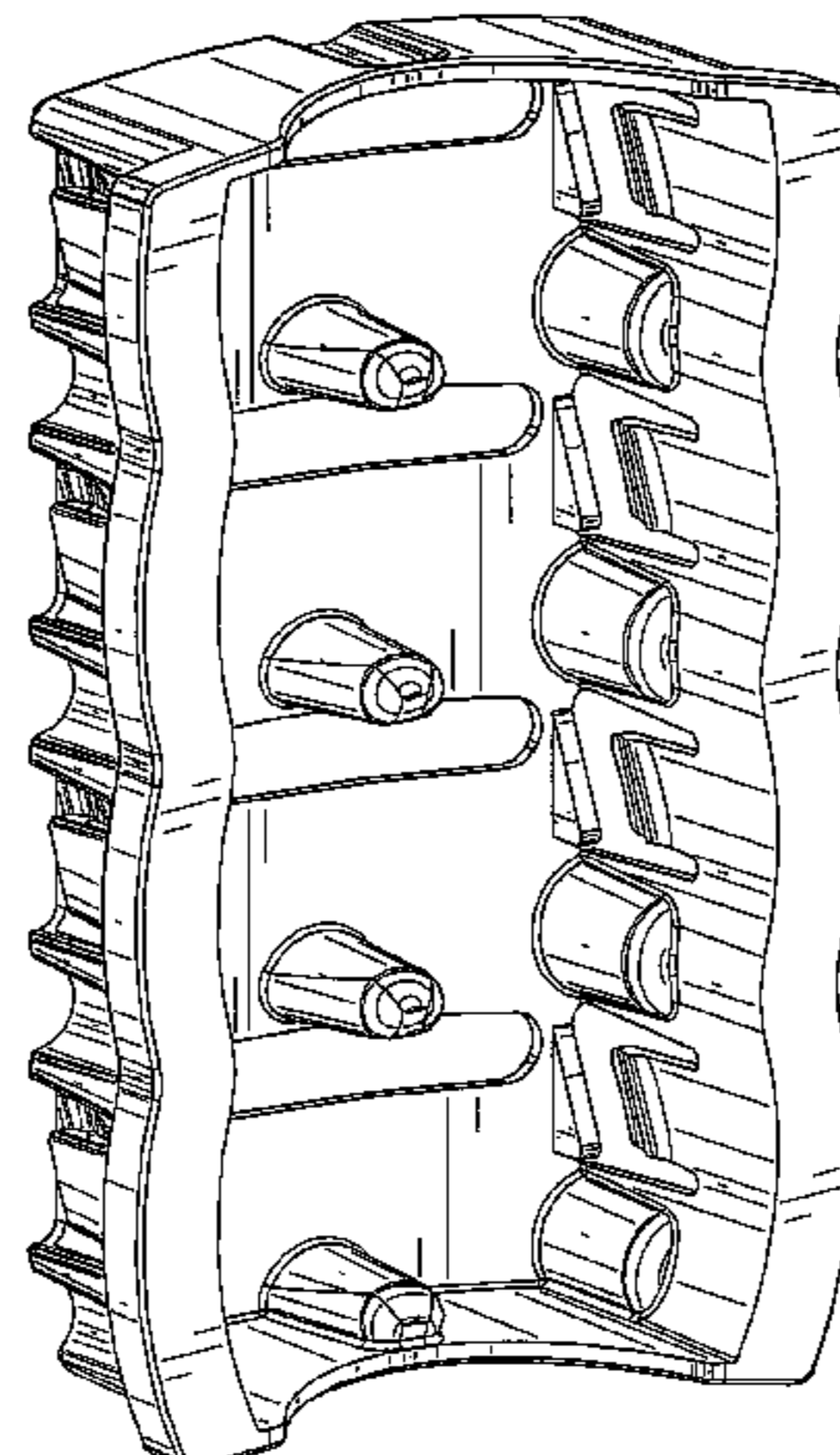

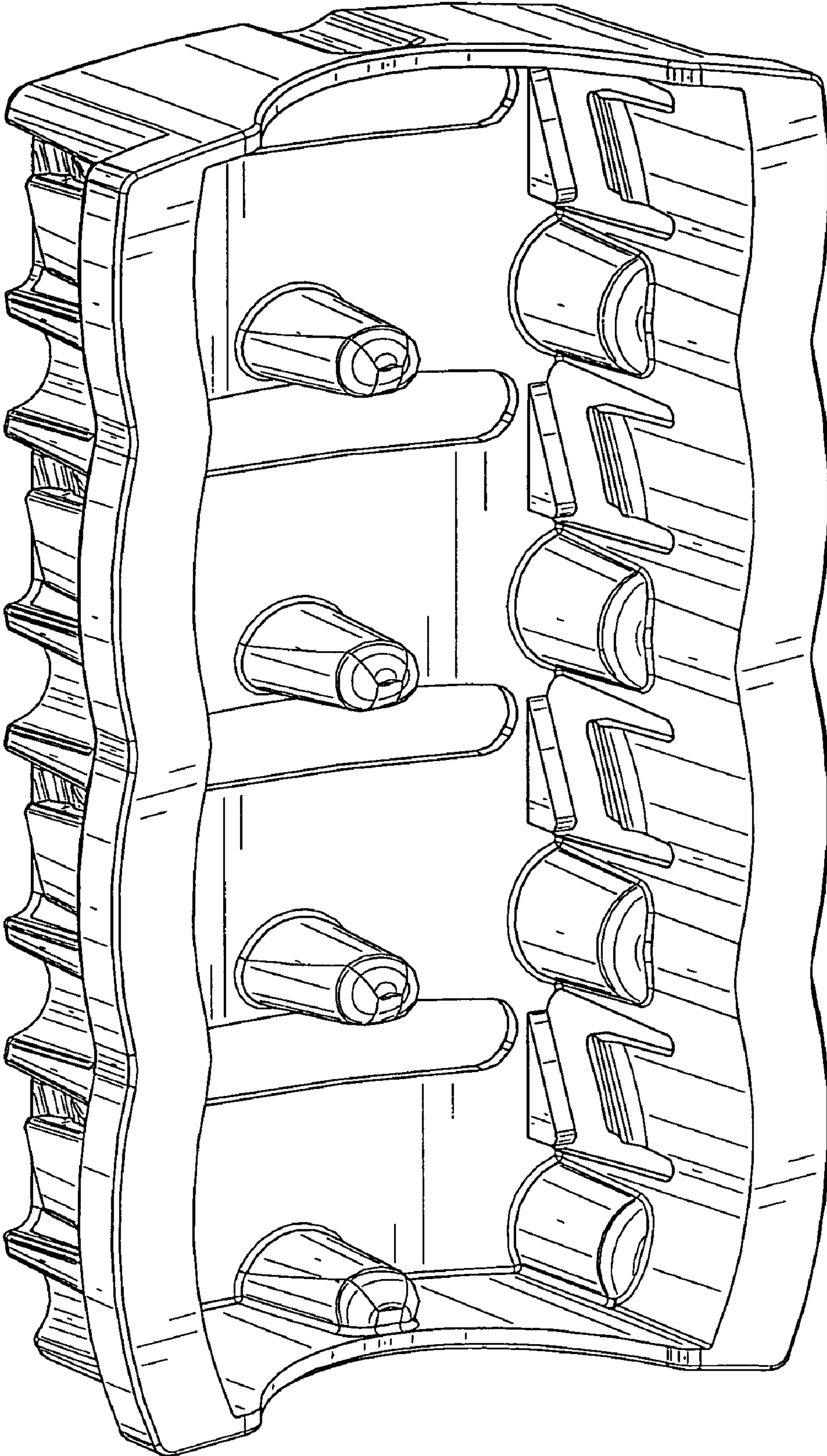

FIG. 1

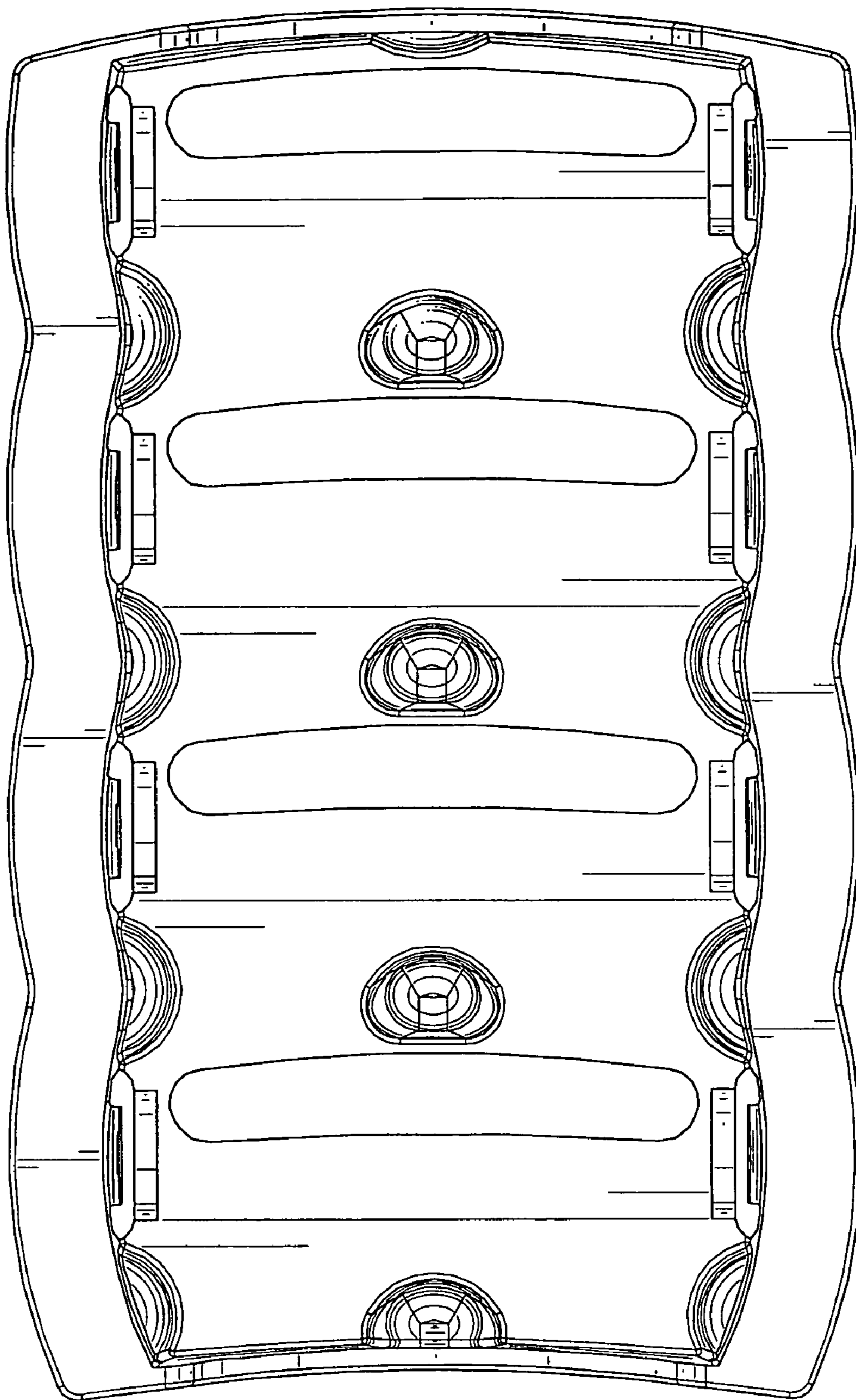

FIG. 2

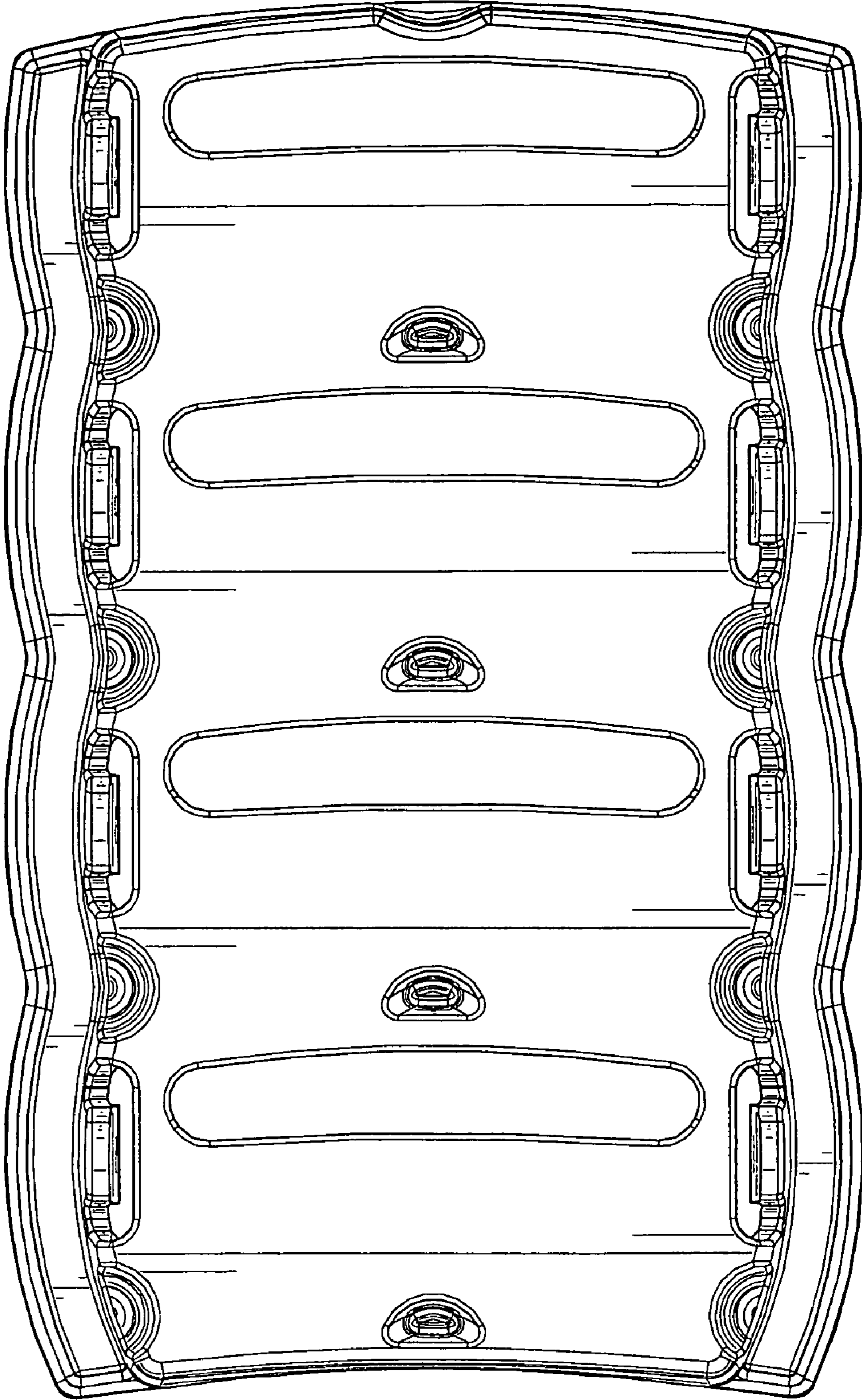

FIG. 3

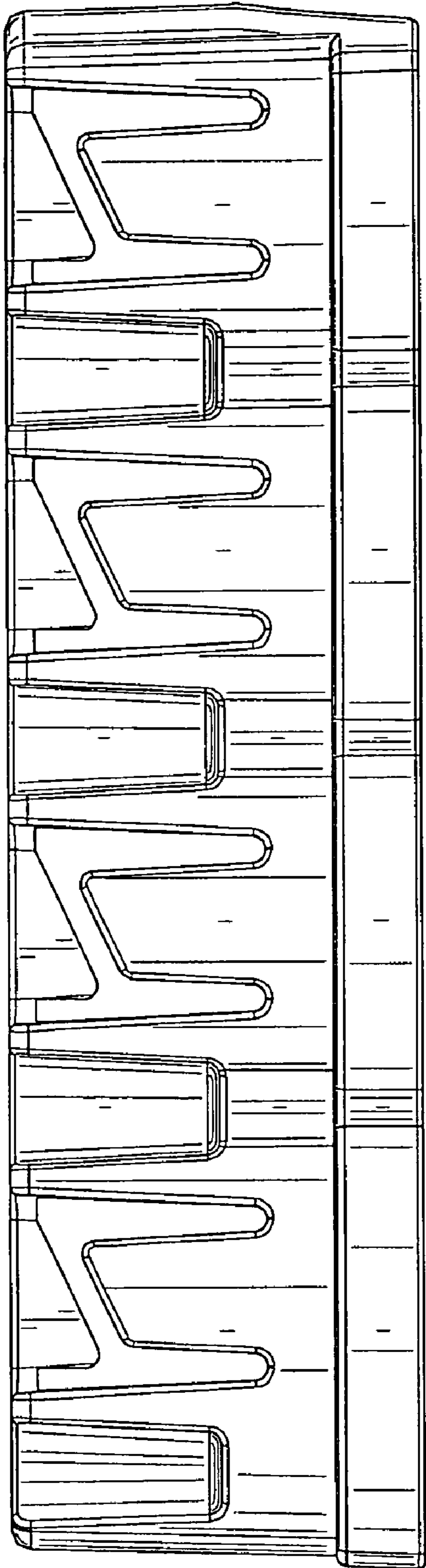

FIG. 4

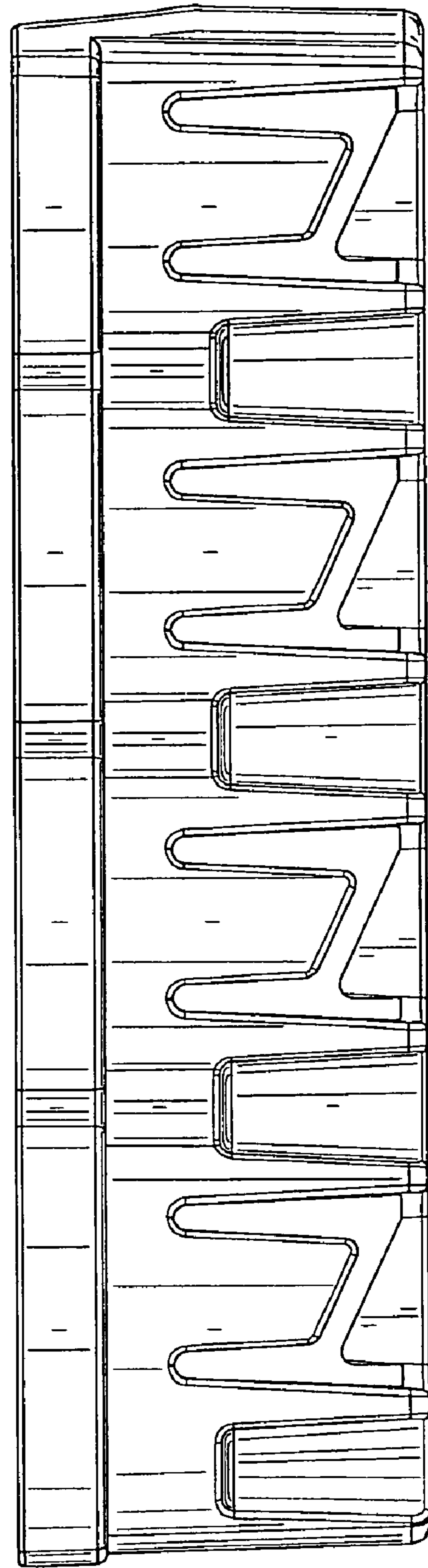

FIG. 5

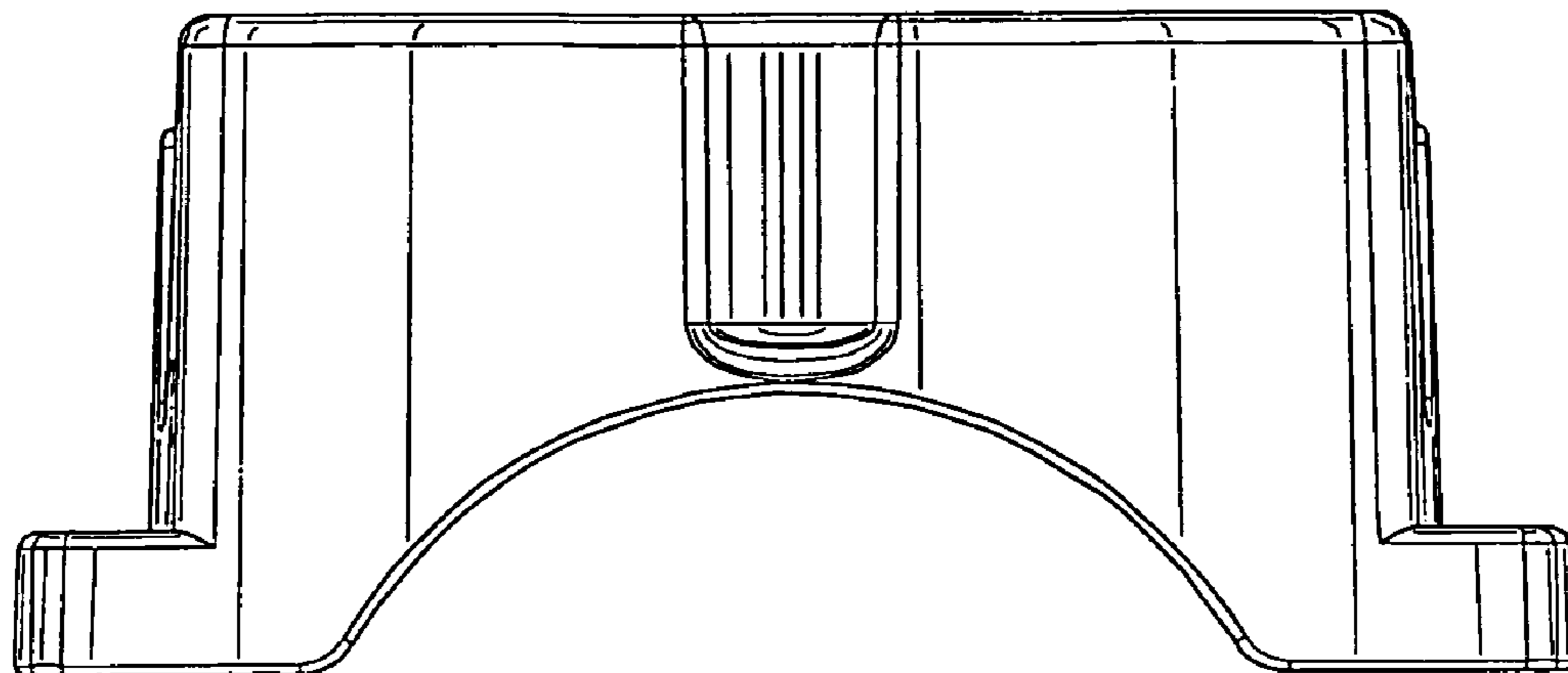

FIG. 6



FIG. 7