

US00D595868S

(12) **United States Design Patent**
Hammer et al.

(10) **Patent No.:** **US D595,868 S**
(45) **Date of Patent:** **** Jul. 7, 2009**

(54) **WALL BLOCK**

(75) Inventors: **James Hammer**, University Place, WA (US); **Kenneth L. Headley**, Birmingham, AL (US)

(73) Assignee: **Westblock Systems, Inc.**, Salem, OR (US)

(**) Term: **14 Years**

(21) Appl. No.: **29/321,106**

(22) Filed: **Jul. 10, 2008**

Related U.S. Application Data

(62) Division of application No. 29/291,125, filed on Aug. 14, 2007, now Pat. No. Des. 575,413.

(51) **LOC (9) Cl.** **25-01**

(52) **U.S. Cl.** **D25/113**

(58) **Field of Classification Search** D25/102-118, D25/164; D21/484, 500, 501; 405/16, 284, 405/286; 404/27-30, 34, 37-42; 52/102, 52/574-576, 596-599, 600-602, 603-605, 52/606-609

See application file for complete search history.

(56) **References Cited**

U.S. PATENT DOCUMENTS

2,703,487	A	3/1955	Ossoinack	
D225,846	S	1/1973	Cruzen, Jr.	
4,301,637	A	11/1981	Anderson	
4,498,266	A	2/1985	Perreton	
4,726,567	A	2/1988	Greenberg	
D333,354	S	2/1993	Adams	
D333,355	S	2/1993	Adams	
D342,795	S	12/1993	Harrison	
5,623,797	A	4/1997	Gravier et al.	
D387,431	S	* 12/1997	Tremblay D25/113
6,065,265	A	5/2000	Stenekes	
D475,143	S	5/2003	Hammer	

D476,749	S	7/2003	Harris et al.	
6,691,471	B2	2/2004	Price	
6,735,913	B2	5/2004	Sanders et al.	
D492,796	S	* 7/2004	Price D25/113
D502,554	S	3/2005	Luaces	
6,862,856	B2	3/2005	Turgeon-Schramm et al.	
D514,233	S	1/2006	Hammer	
D527,113	S	8/2006	Rainey	
D532,119	S	11/2006	Hammer	
2003/0074856	A1	4/2003	Hammer	
2008/0168725	A1	* 7/2008	Malone 52/259

OTHER PUBLICATIONS

Drawings of BarrierStone blocks, on sale prior to Nov. 17, 2003 (2 pgs).

Notice of Allowance from the United States Patent & Trademark Office in U.S. Appl. No. 29/291,125, dated Apr. 11, 2008.

* cited by examiner

Primary Examiner—T. Chase Nelson

Assistant Examiner—Anhdao Doan

(74) *Attorney, Agent, or Firm*—Klarquist Sparkman, LLP

(57) **CLAIM**

We claim the ornamental design for a wall block, as shown and described.

DESCRIPTION

FIG. 1 is a perspective view of a wall block, as viewed from the front, top, and one side of the block.

FIG. 2 is a top plan view of the block of FIG. 1.

FIG. 3 is a side elevation view of one side of the block of FIG. 1.

FIG. 4 is a front elevation view of the front of the block of FIG. 1, the back of the block being a mirror image thereof.

FIG. 5 is a side elevation view of the block of FIG. 1, showing the side opposite of that shown in FIG. 3; and,

FIG. 6 is a bottom plan view of the block of FIG. 1.

1 Claim, 2 Drawing Sheets

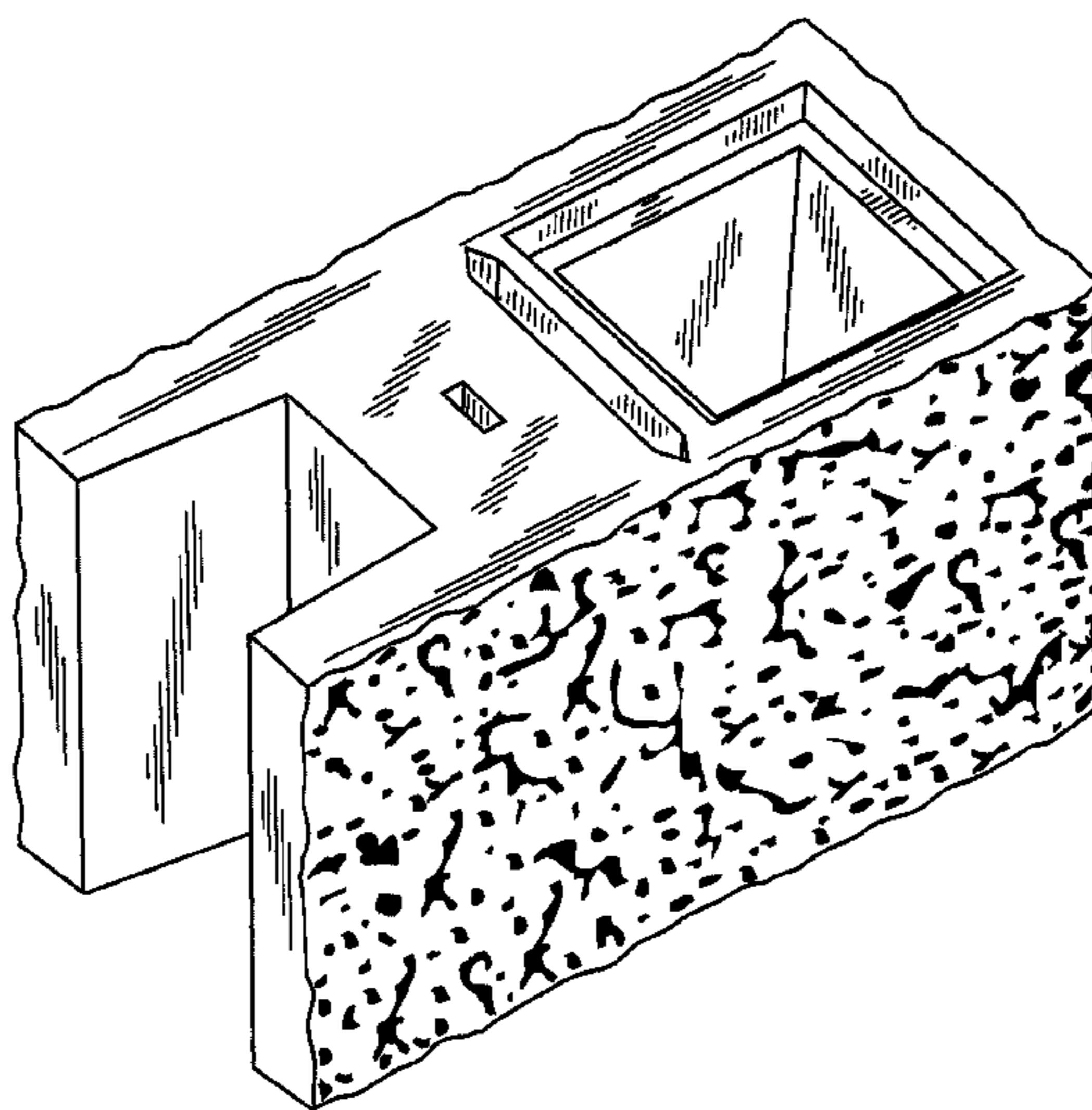

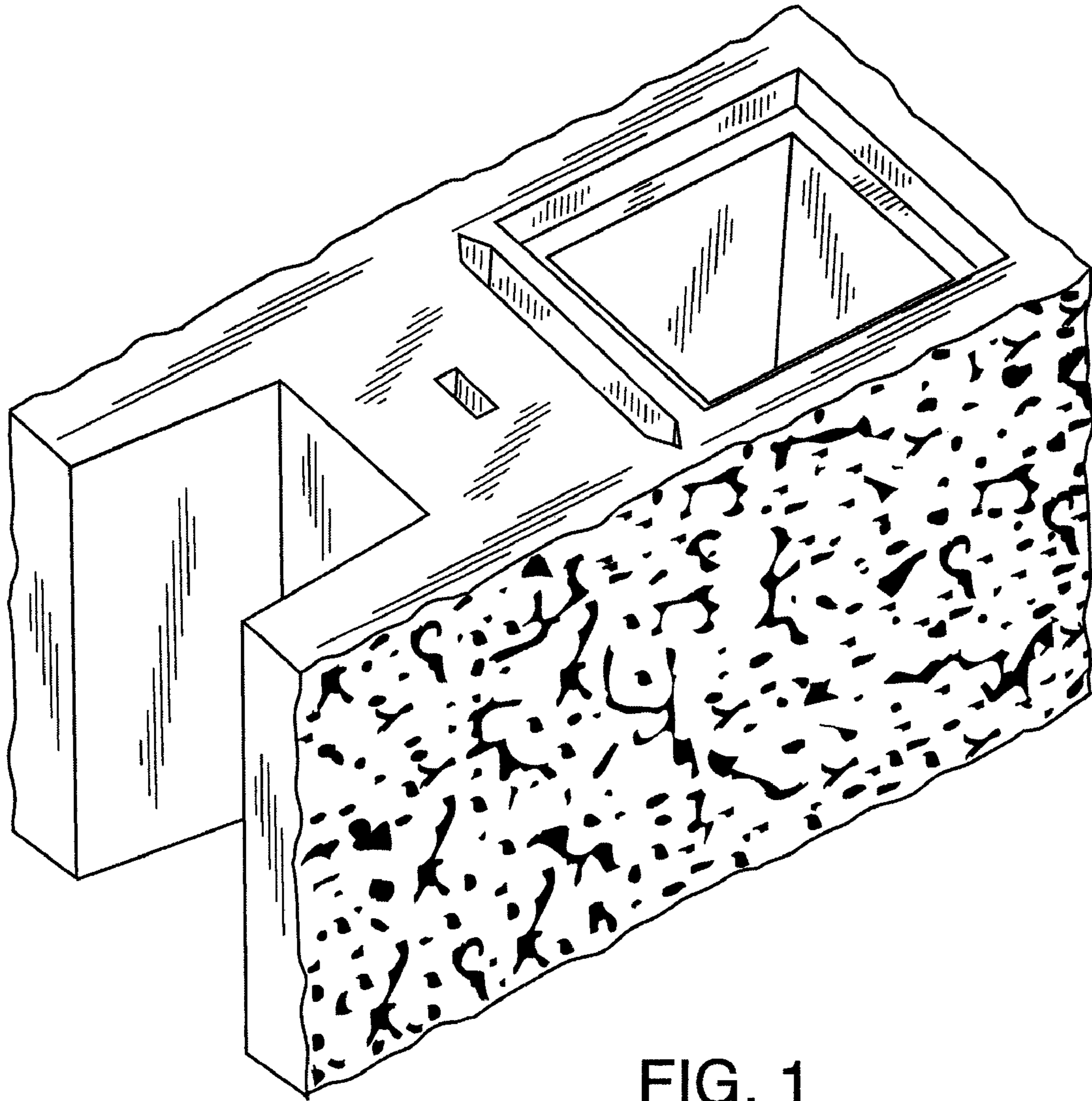

FIG. 1

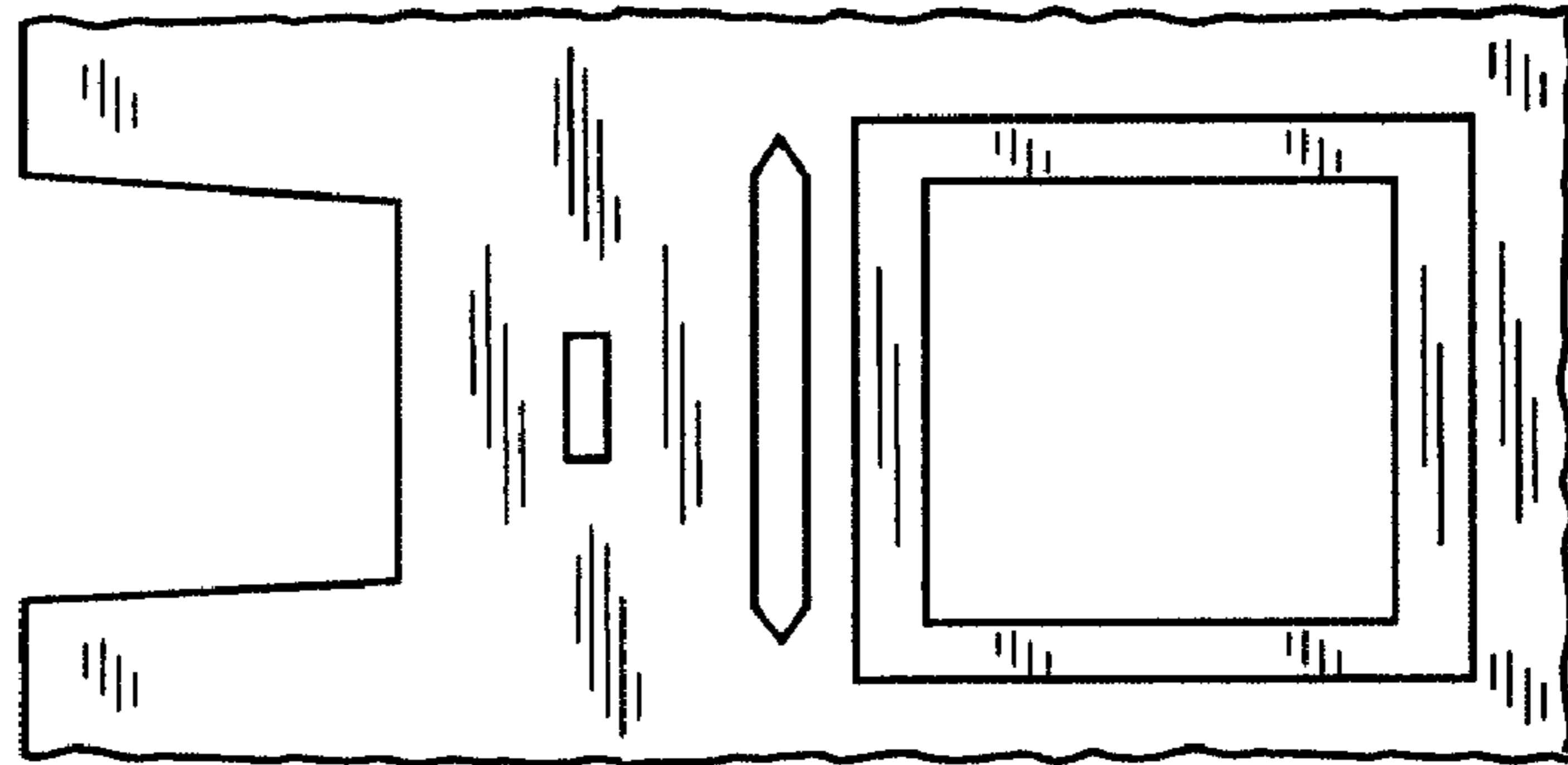

FIG. 2

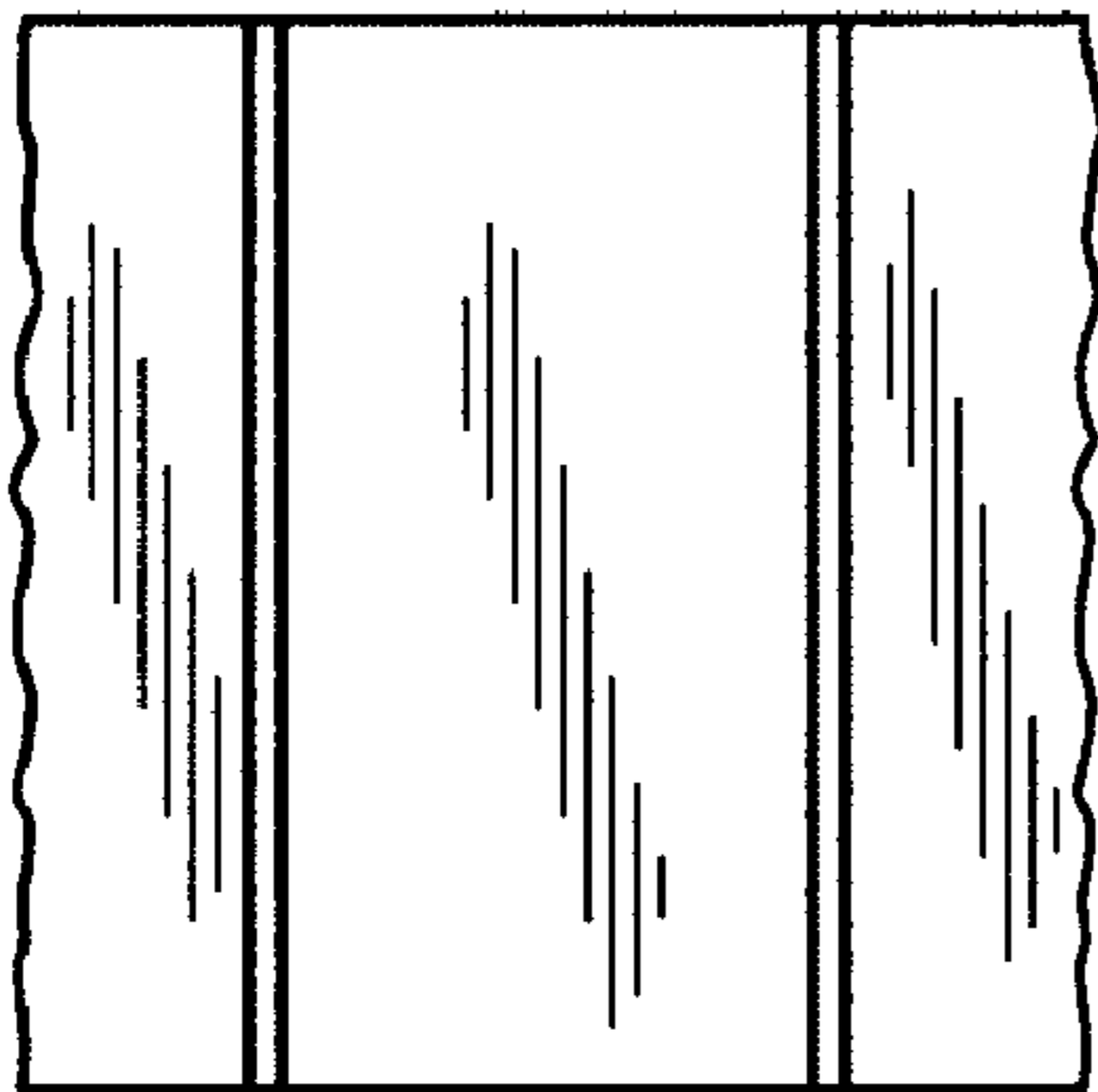

FIG. 3

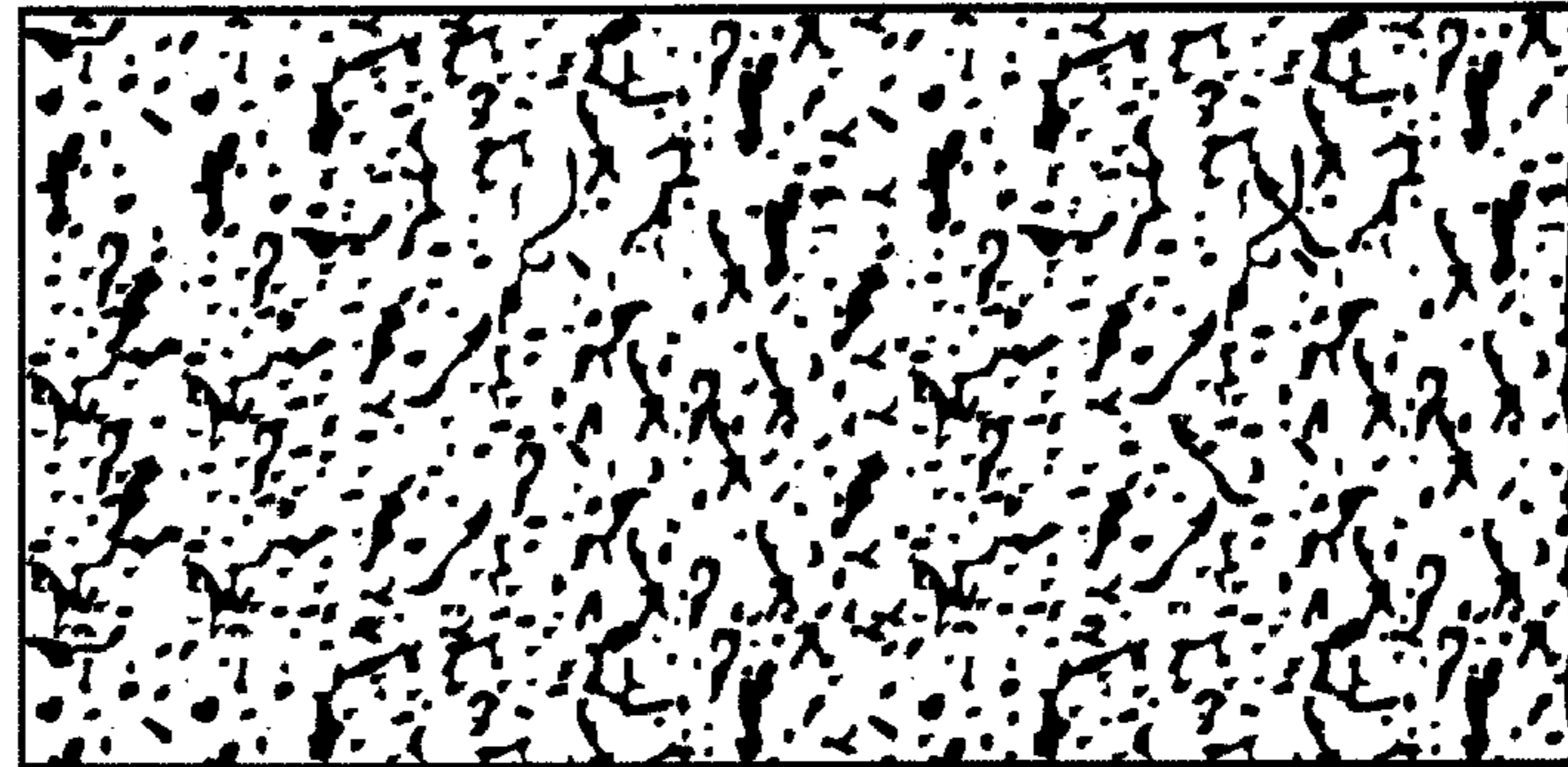

FIG. 4

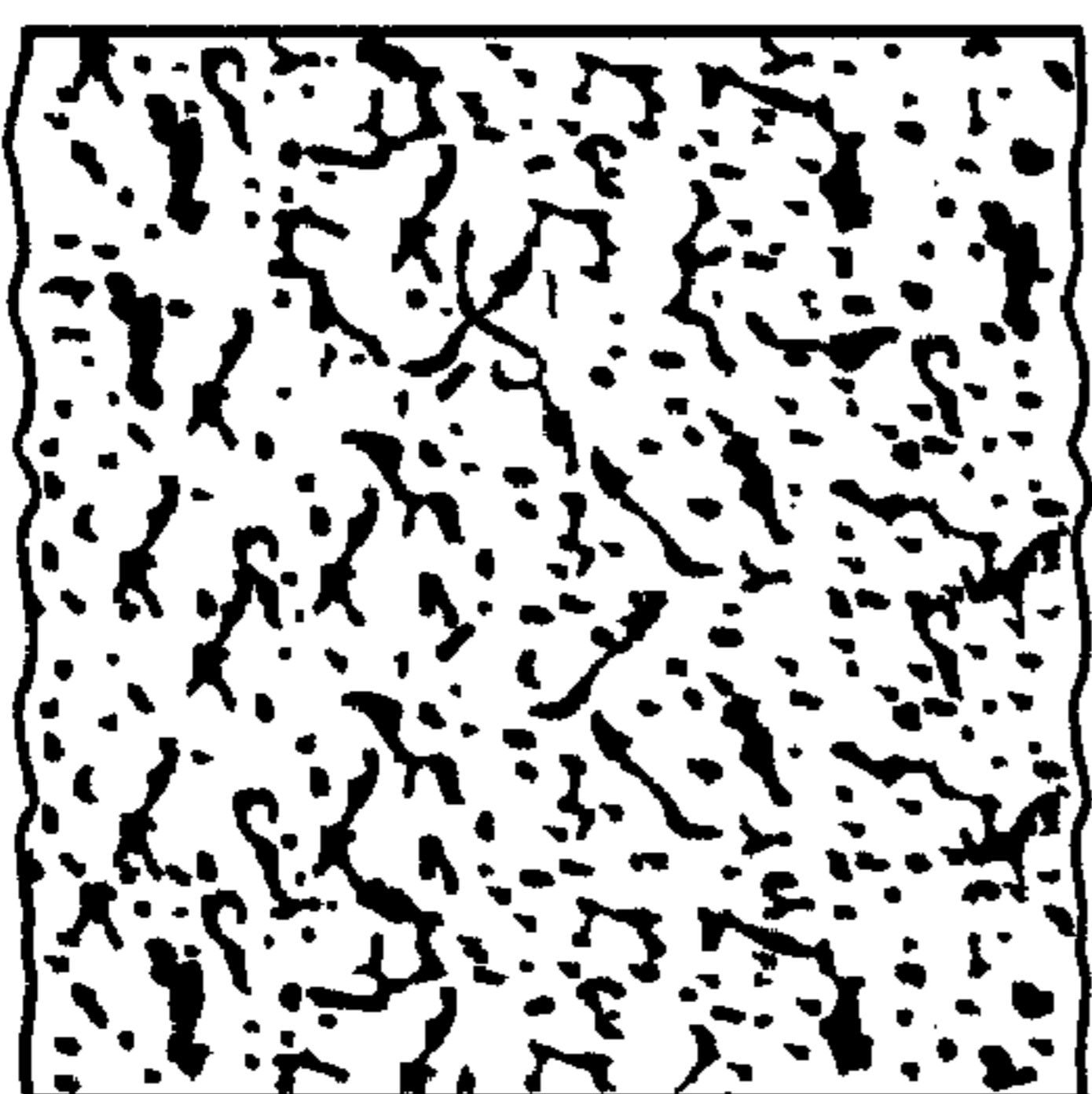

FIG. 5

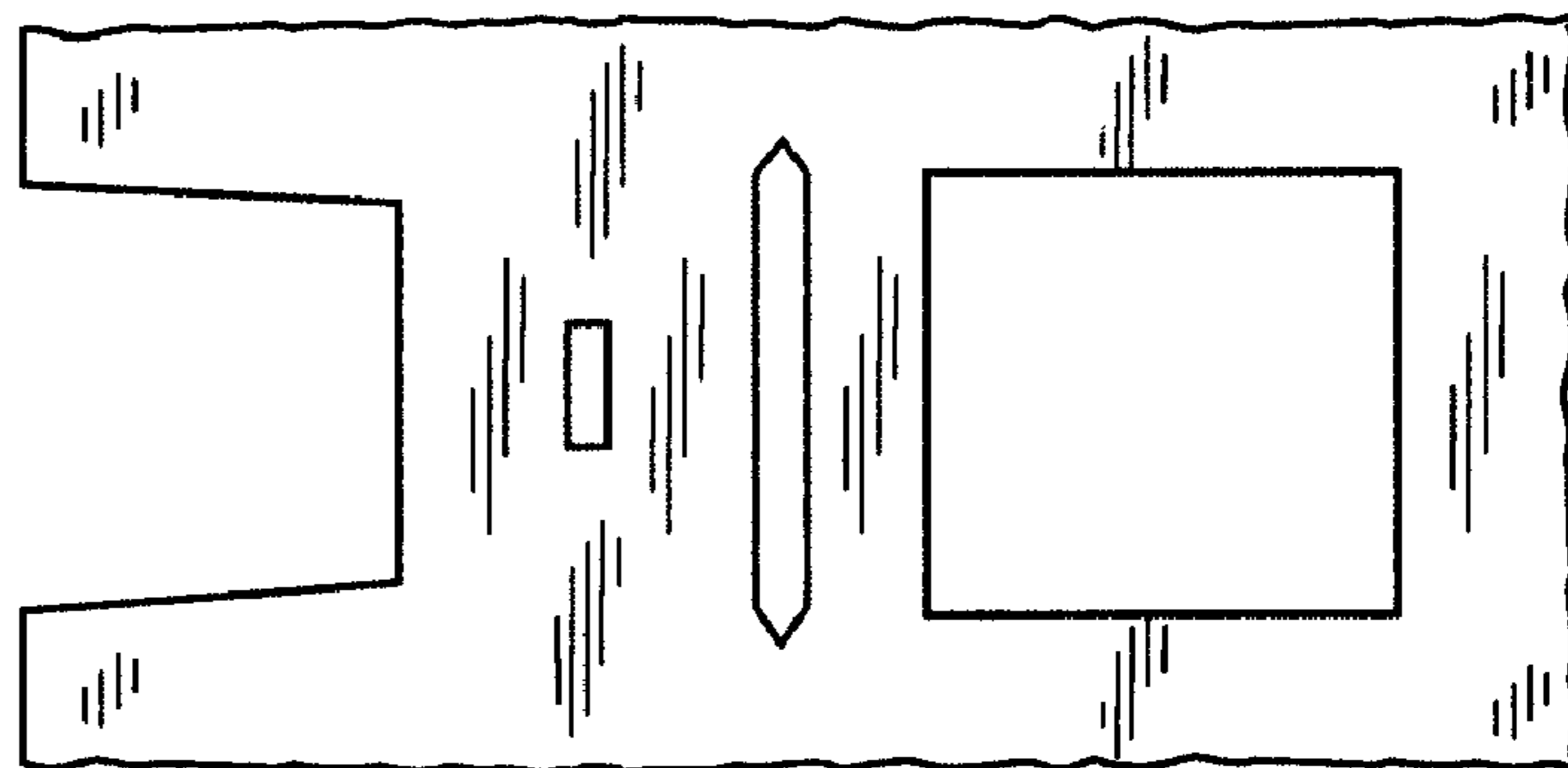

FIG. 6