



US00D595817S

(12) **United States Design Patent**
Stanchak et al.

(10) **Patent No.:** **US D595,817 S**
(45) **Date of Patent:** **** Jul. 7, 2009**

(54) **PLUMBING FIXTURE**

(75) Inventors: **Katherine A. Stanchak**, Sheboygan, WI (US); **Herbert V. Kohler, Jr.**, Kohler, WI (US)

(73) Assignee: **Kohler Co.**, Kohler, WI (US)

(**) Term: **14 Years**

(21) Appl. No.: **29/325,677**

(22) Filed: **Oct. 3, 2008**

Related U.S. Application Data

(63) Continuation of application No. 29/303,739, filed on Feb. 15, 2008.

(51) **LOC (9) Cl.** **23-02**

(52) **U.S. Cl.** **D23/277**

(58) **Field of Classification Search** D23/293,
D23/275-280.1, 303, 304-306; D24/204;
4/663, 538-539, 541.1, 546, 586, 574.1

See application file for complete search history.

(56) **References Cited**

U.S. PATENT DOCUMENTS

1,849,346 A	3/1932	Cromwell	
D101,637 S	10/1936	Kohler et al.	
D118,371 S	1/1940	Goeltz	
D122,594 S	9/1940	Goeltz	
D144,429 S	4/1946	Stanitz	
D156,052 S	11/1949	Springwell	
2,572,463 A	10/1951	Fine	
D482,763 S *	11/2003	Thomas D23/280.1
D490,144 S	5/2004	Lanius	
D514,206 S	1/2006	Bates	

OTHER PUBLICATIONS

Kallista. "Michael S. Smith Country Tub Surround". Model No. P50037. Kallista Catalog. Copyright 2001. Kallista. Inc.

Americh. "Concorde 7034". HomePortfolio.com online catalog. Copyright 1997-2007 HomePortfolio.com.

* cited by examiner

Primary Examiner—Robert A Delehanty

(74) *Attorney, Agent, or Firm*—Quarles & Brady LLP

(57) **CLAIM**

The ornamental design for a plumbing fixture, as shown and described.

DESCRIPTION

In a preferred embodiment, the nature of this product is as a plumbing fixture in the form of a bathing tub or portion thereof.

FIG. 1 is a left, top, front perspective view of a plumbing fixture embodying our new design;

FIG. 2 is a top plan view thereof;

FIG. 3 is a front elevational view thereof;

FIG. 4 is a rear elevational view thereof;

FIG. 5 is a left side elevational view thereof;

FIG. 6 is a right side elevational view thereof;

FIG. 7 is a bottom plan view thereof;

FIG. 8 is a right, top, front perspective view of a plumbing fixture according to another embodiment of our new design, the top plan, front elevational, rear elevational, left side elevational, right side elevational and bottom plan views thereof being mirror images of the views shown in respective FIGS. 2-7;

FIG. 9 is a left, top, front perspective view of a plumbing fixture according to another embodiment of our new design;

FIG. 10 is a top plan view thereof;

FIG. 11 is a front elevational view thereof;

FIG. 12 is a rear elevational view thereof;

FIG. 13 is a left side elevational view thereof;

FIG. 14 is a right side elevational view thereof;

FIG. 15 is a bottom plan view thereof; and,

FIG. 16 is a right, top, front perspective view of a plumbing fixture according to another embodiment of our new design, the top plan, front elevational, rear elevational, left side elevational, right side elevational and bottom plan views thereof being mirror images of the views shown in respective FIGS. 10-15.

The broken line representations in the figures, are for the purpose of illustration only, and form no part of the claimed design.

1 Claim, 12 Drawing Sheets

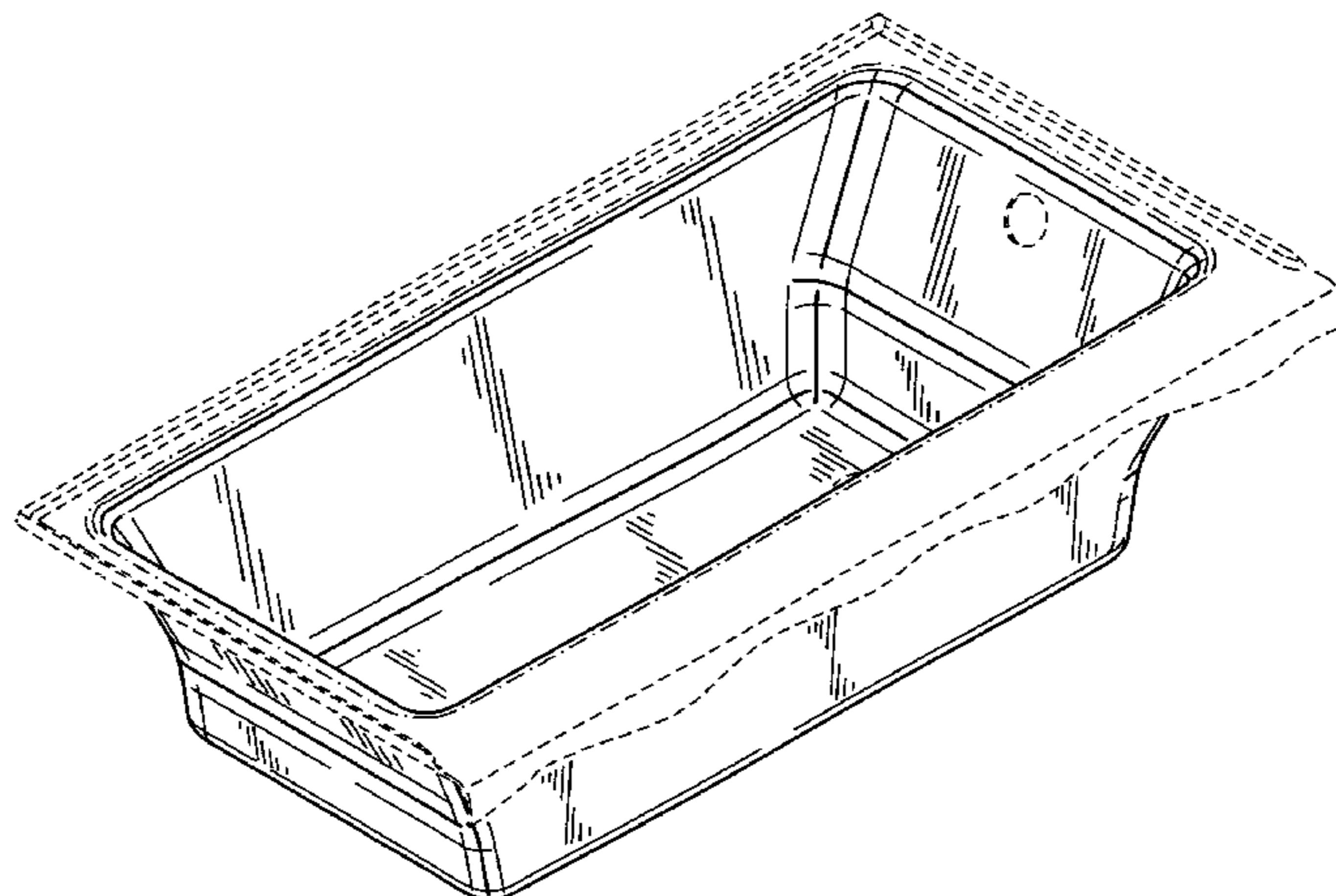

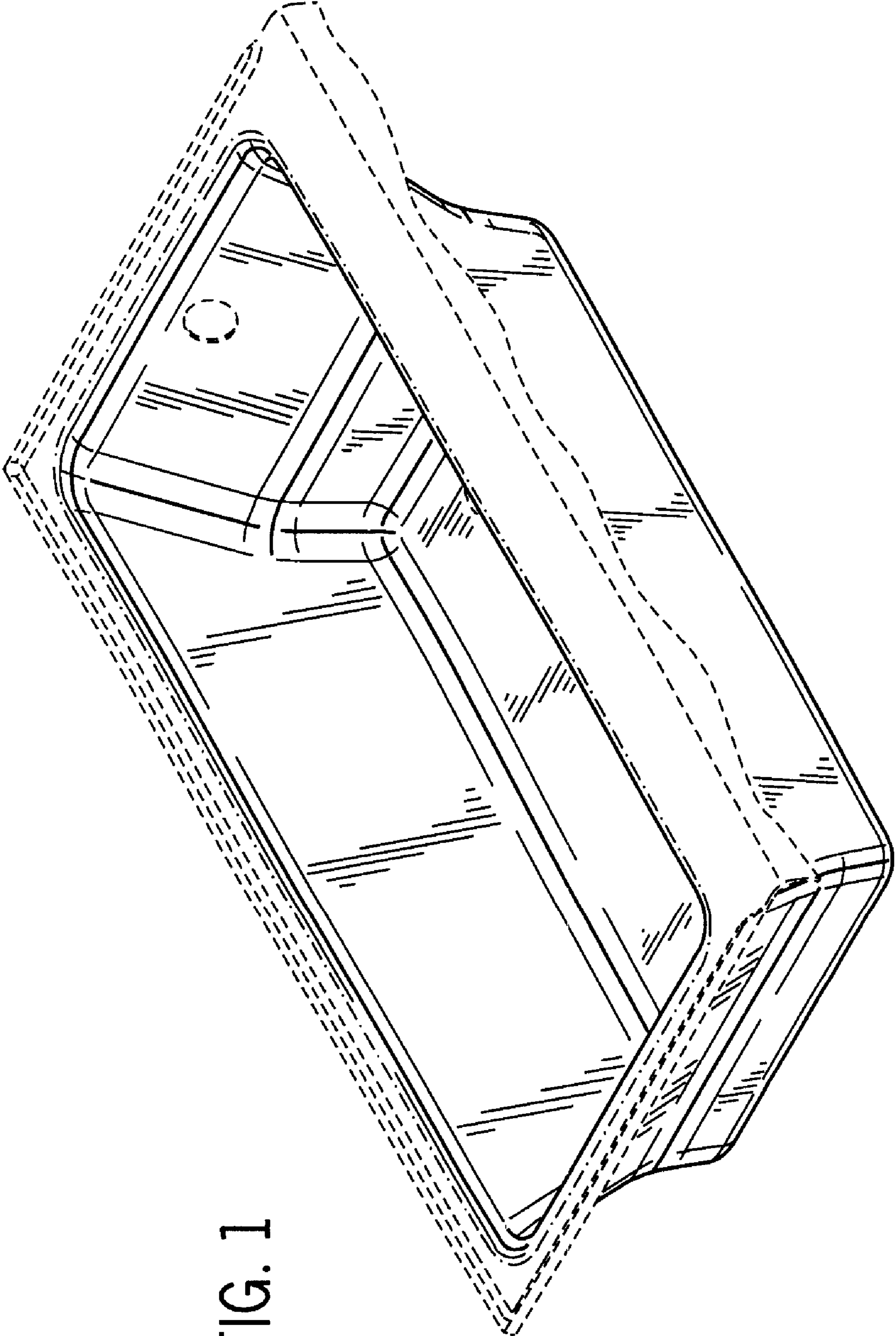

FIG. 1

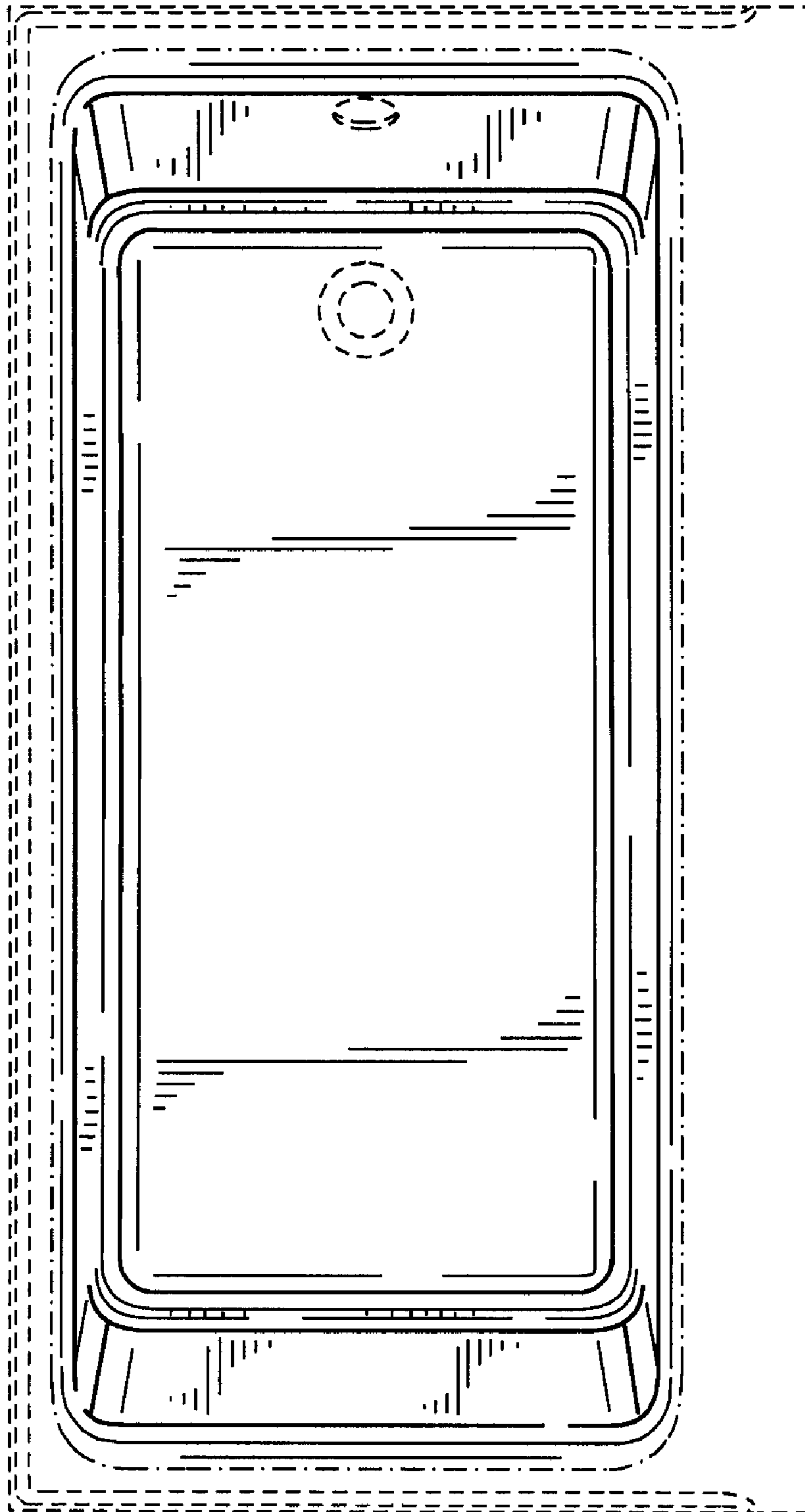

FIG. 2

FIG. 3

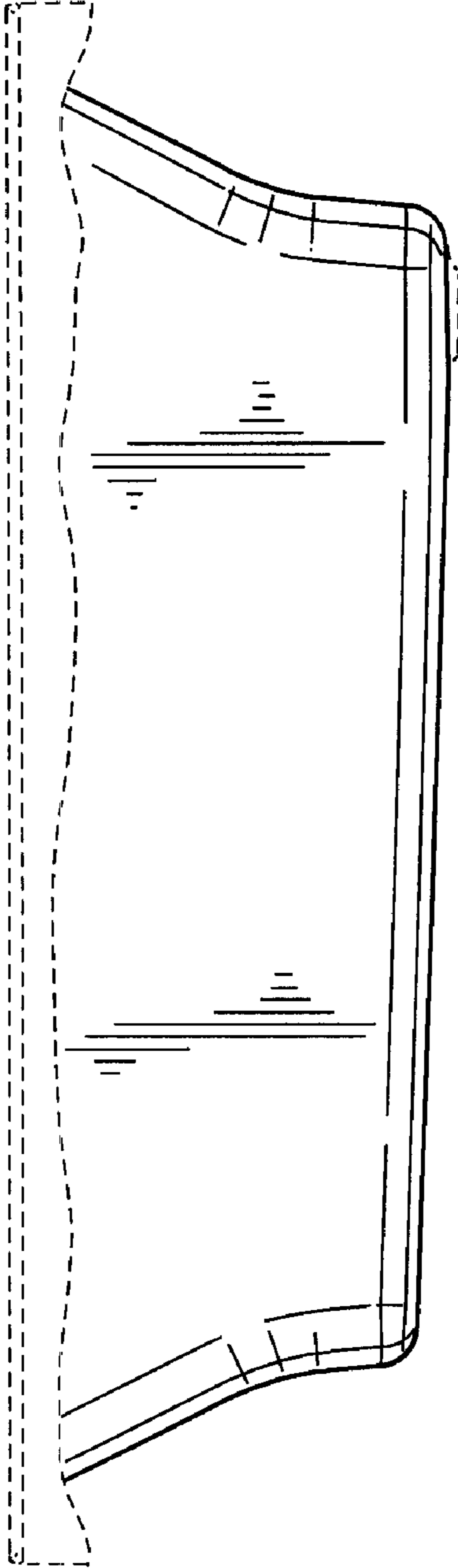
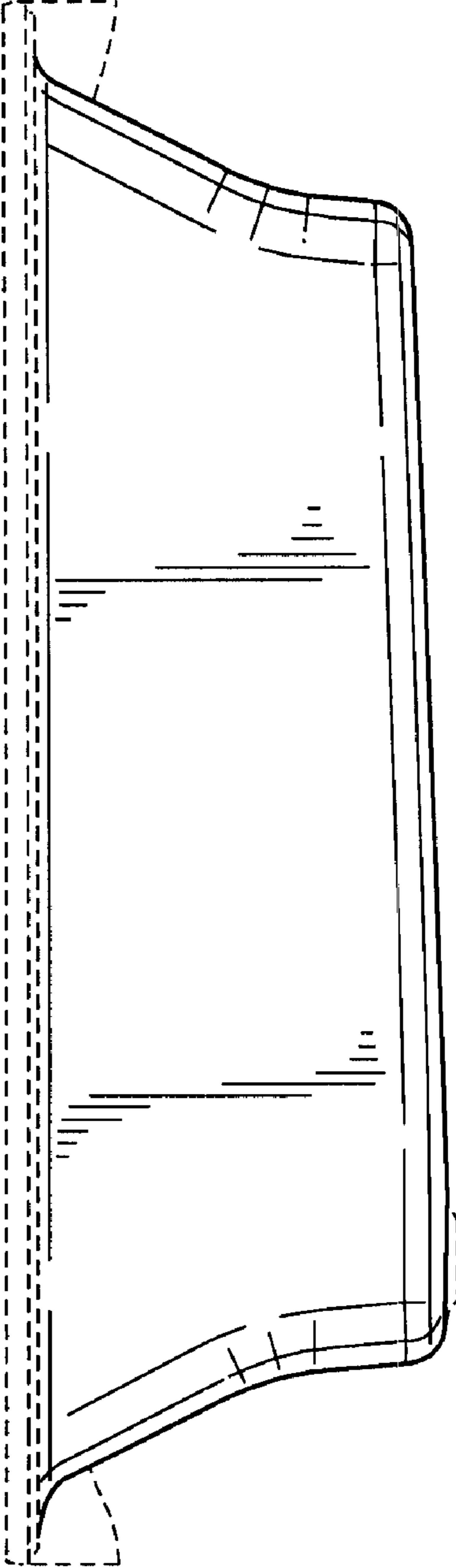

FIG. 4



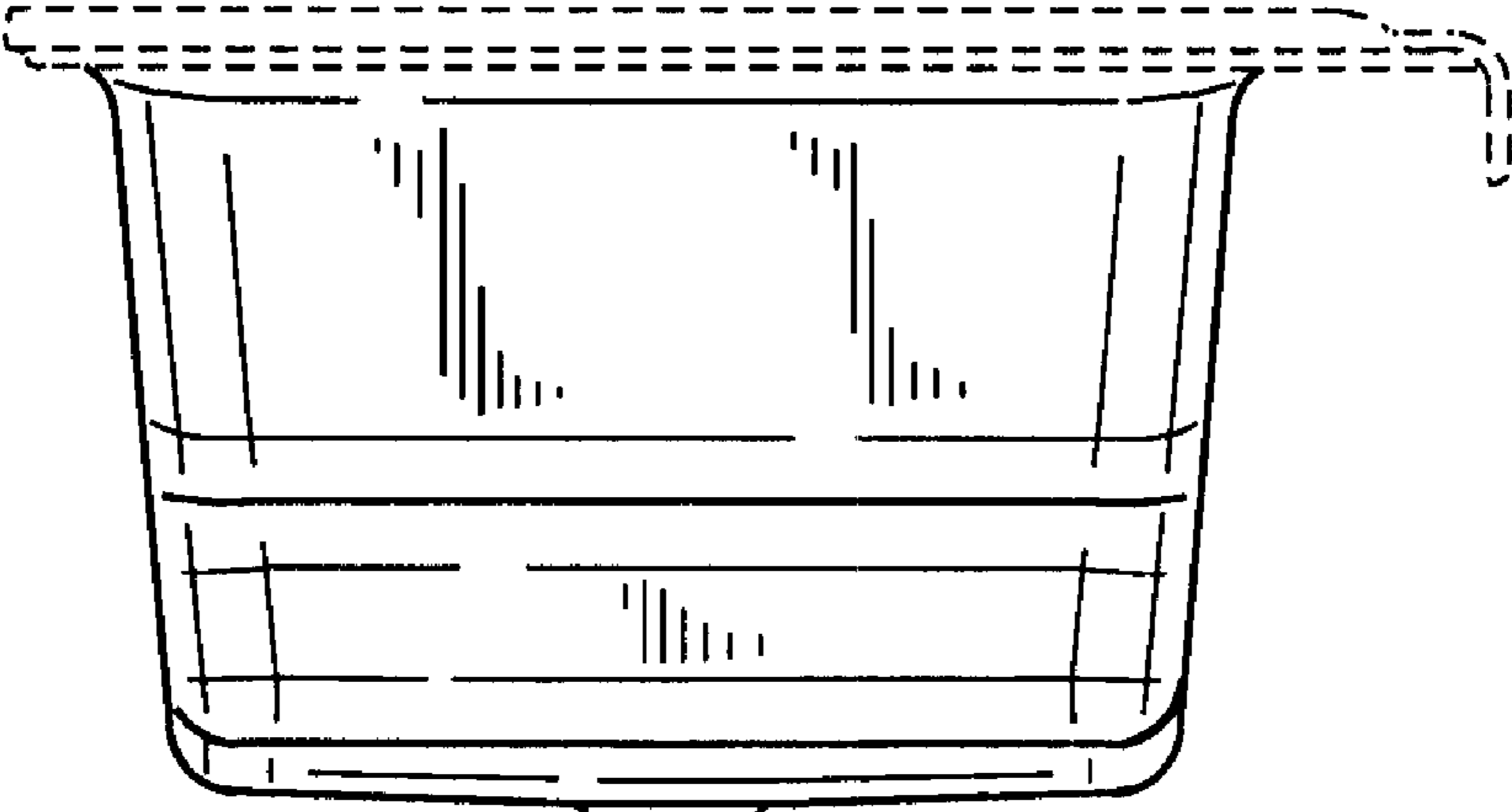

FIG. 5

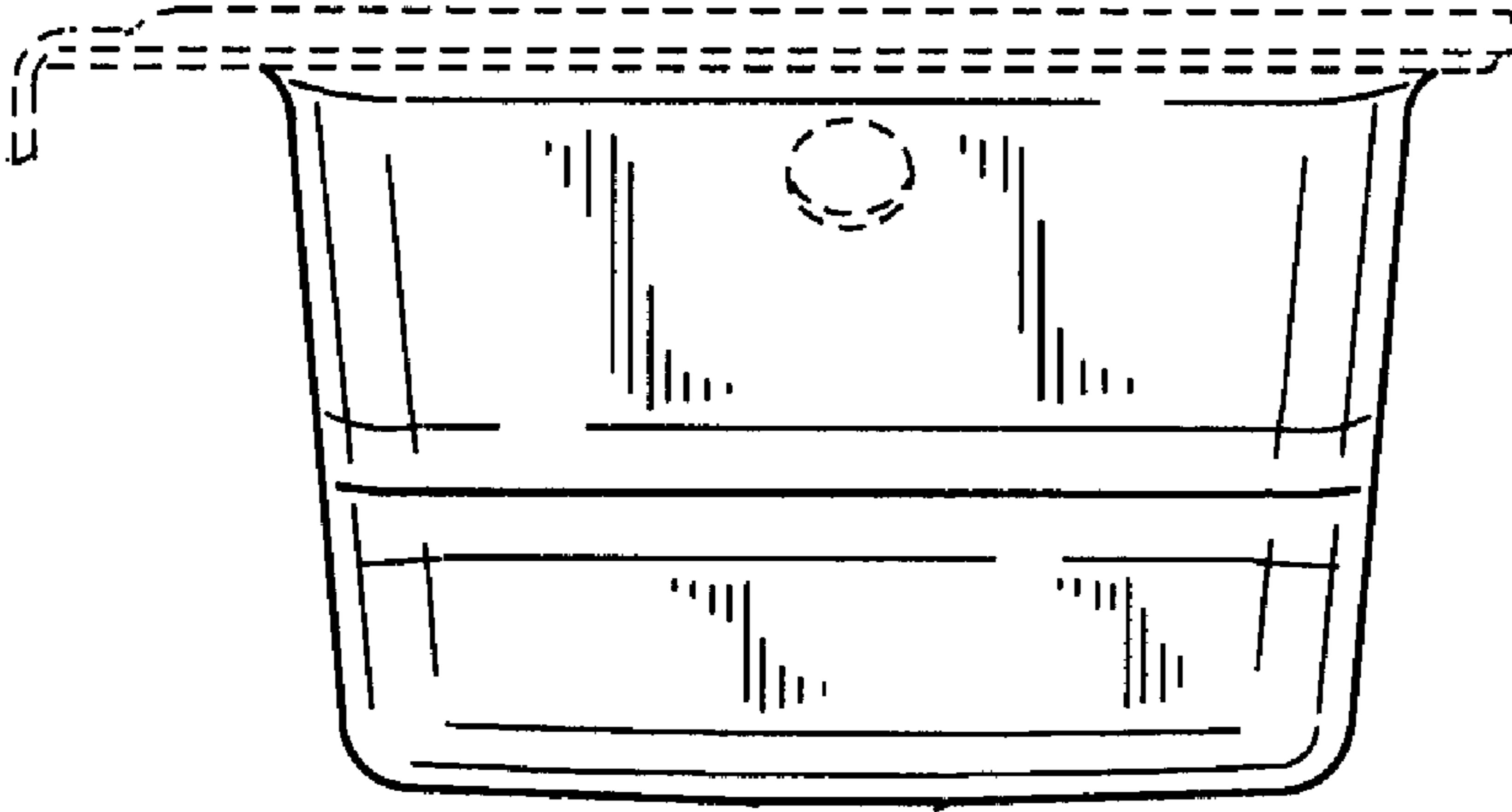

FIG. 6

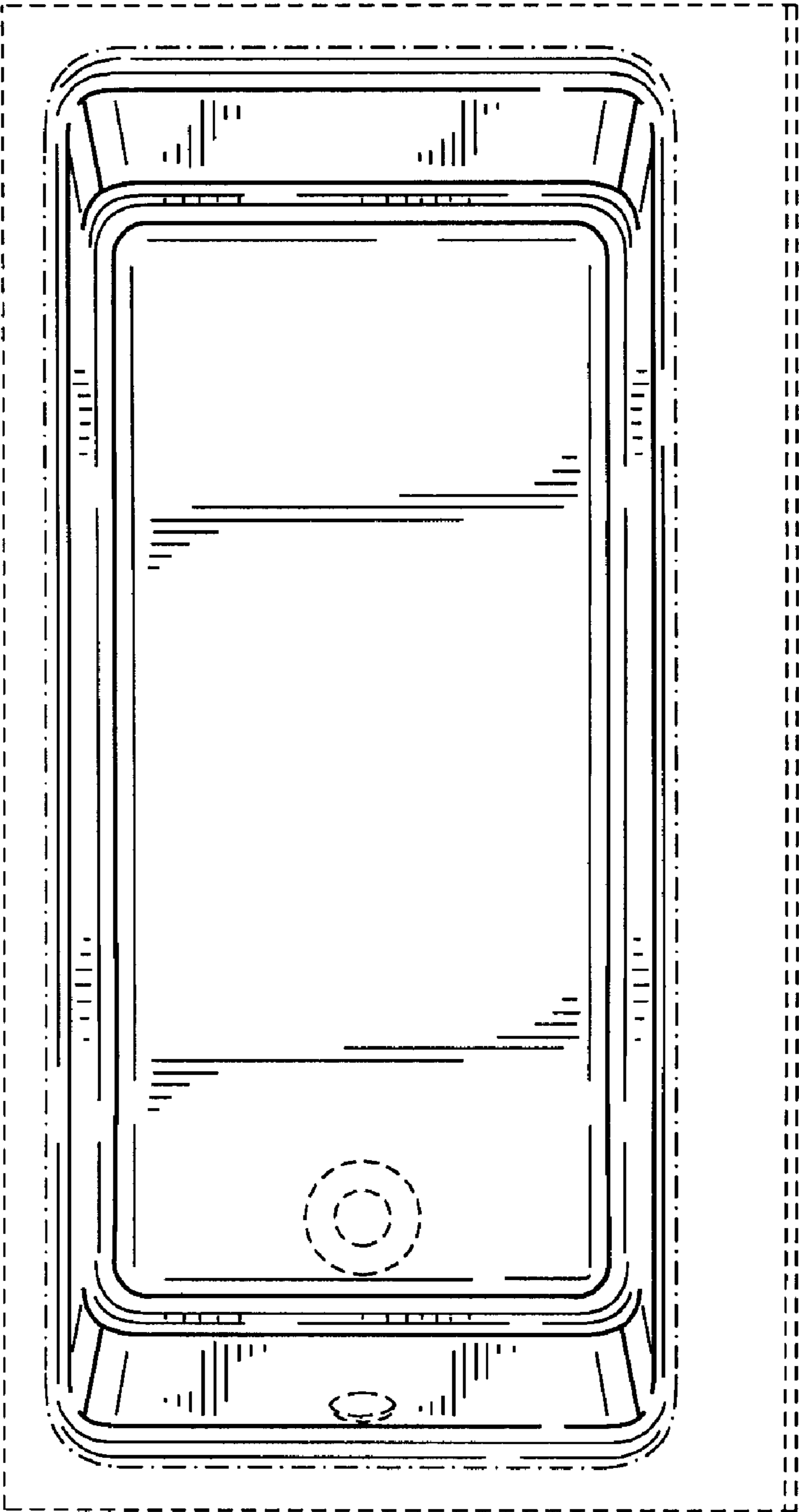

FIG. 7

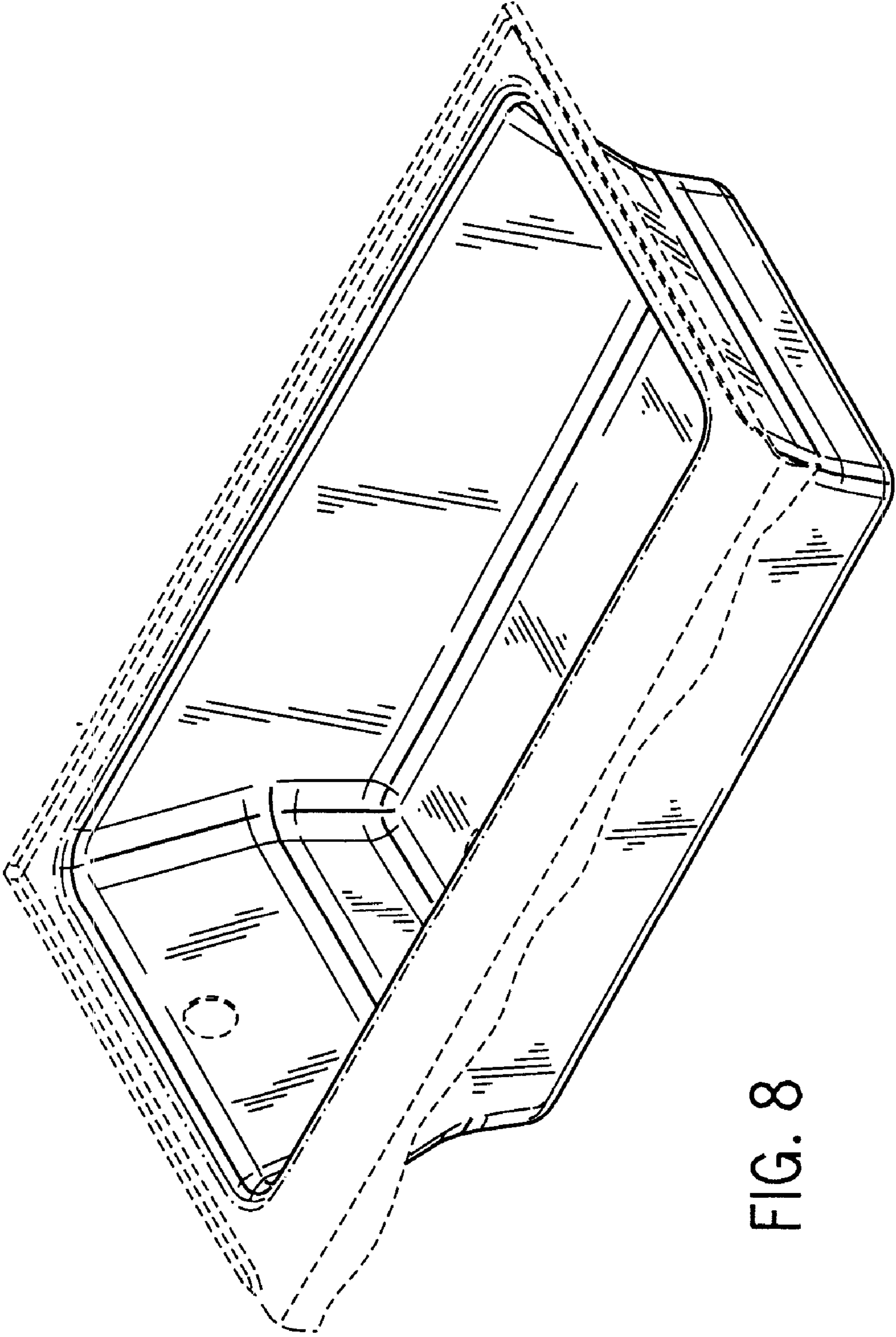

FIG. 8

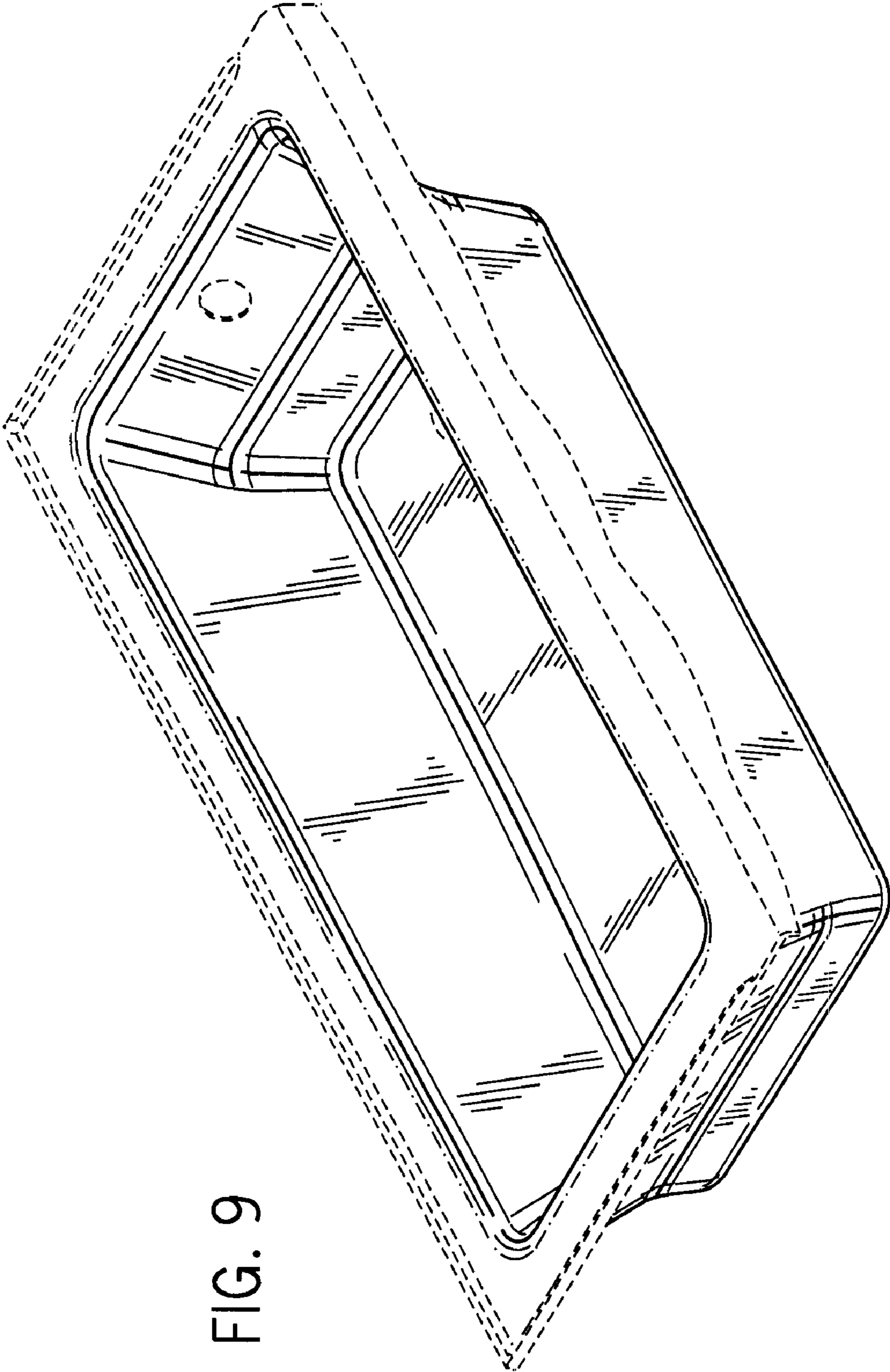

FIG. 9

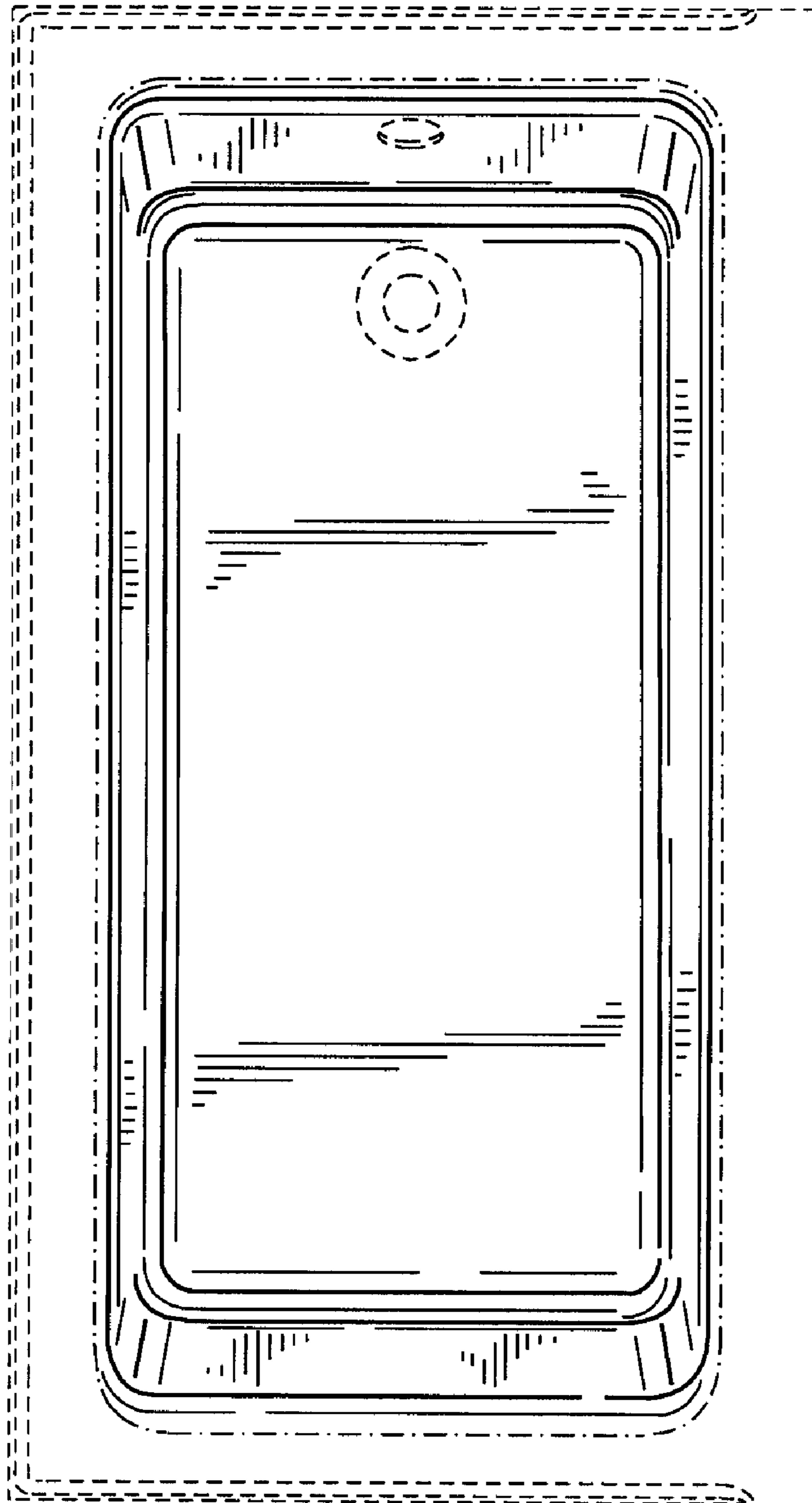

FIG. 10

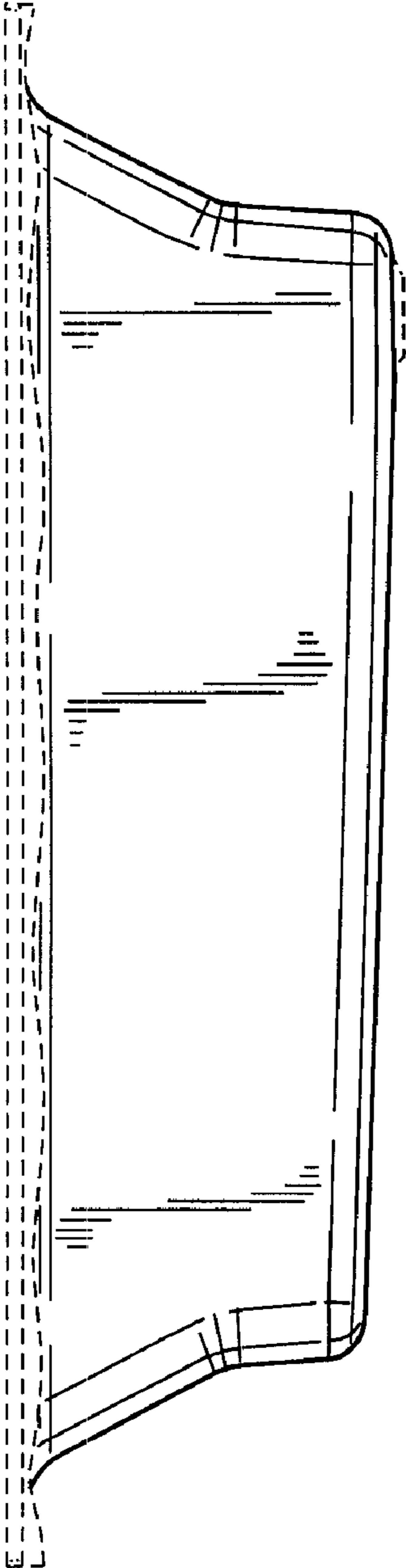

FIG. 11

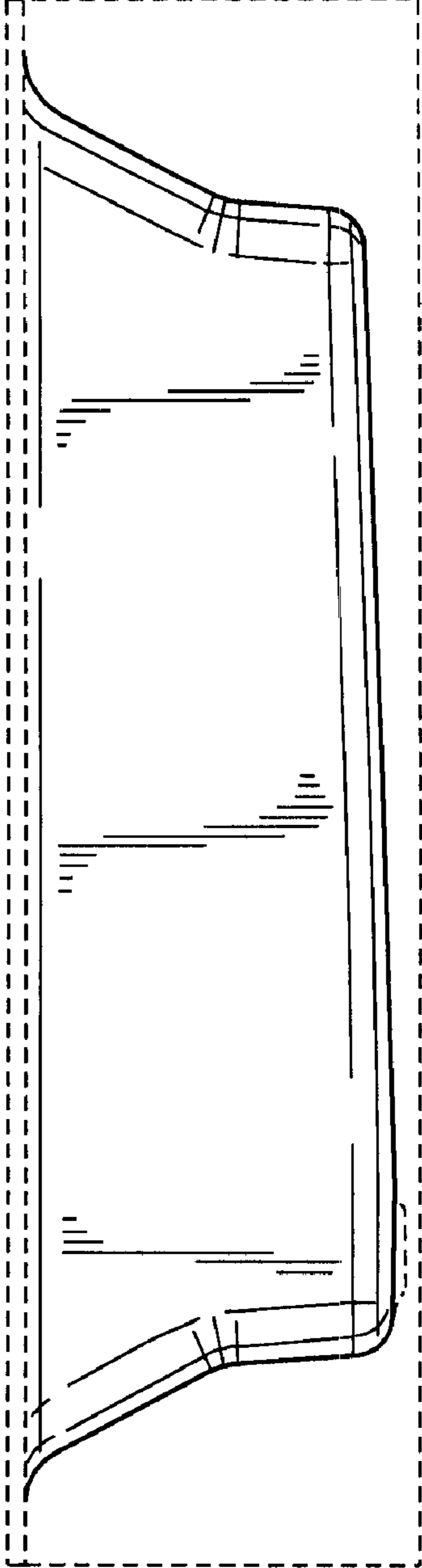

FIG. 12

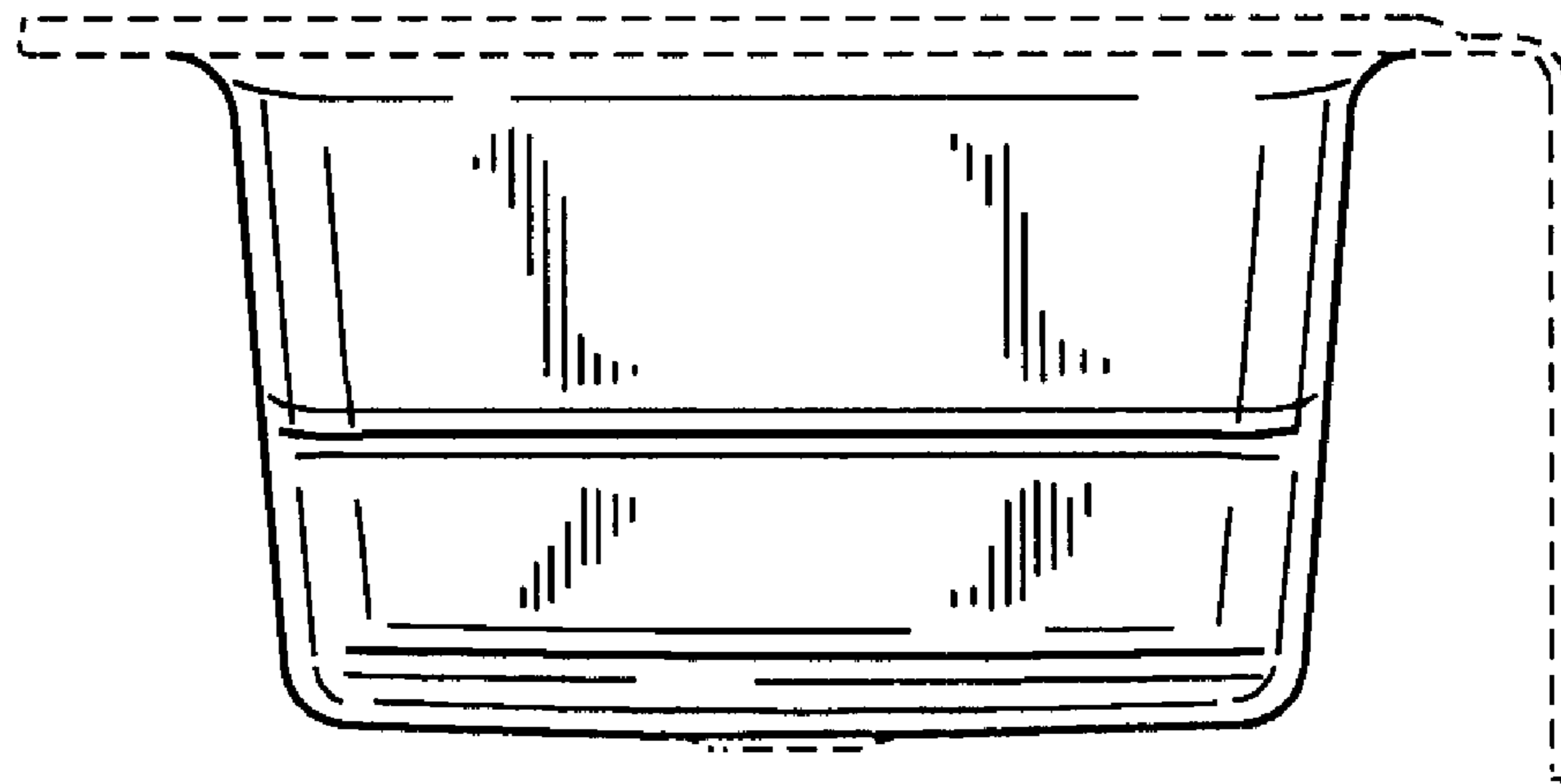

FIG. 13

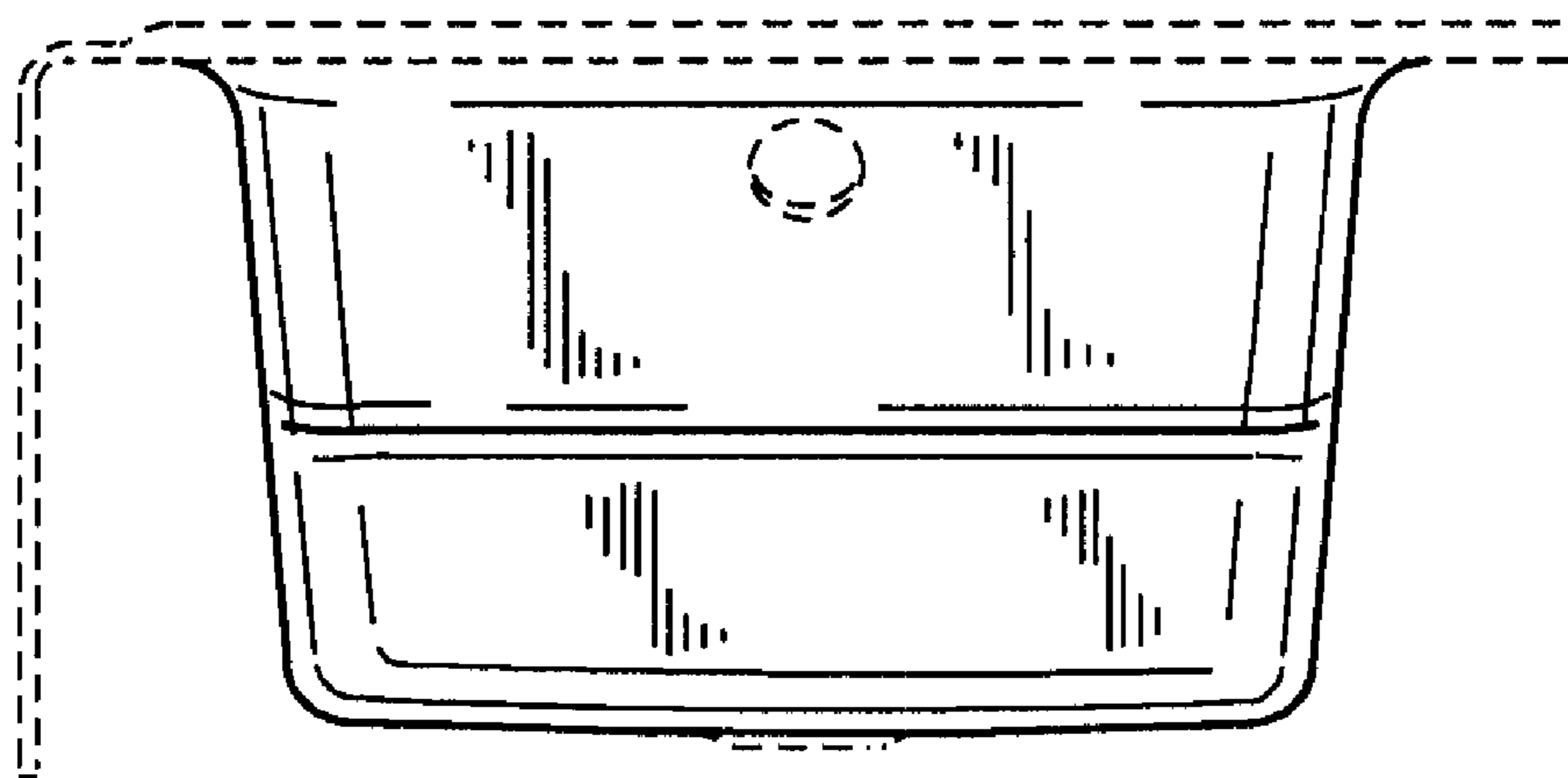

FIG. 14

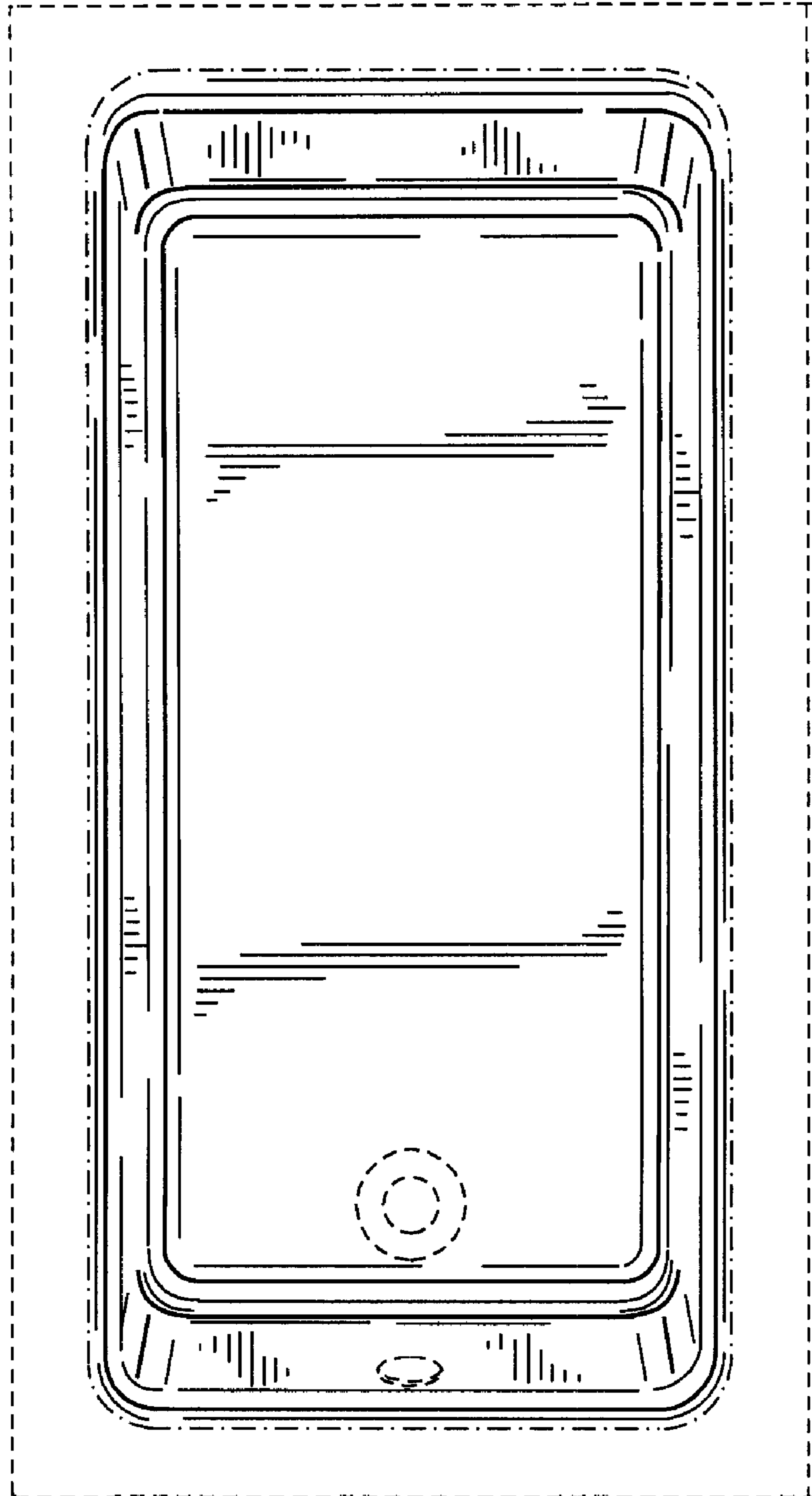

FIG. 15

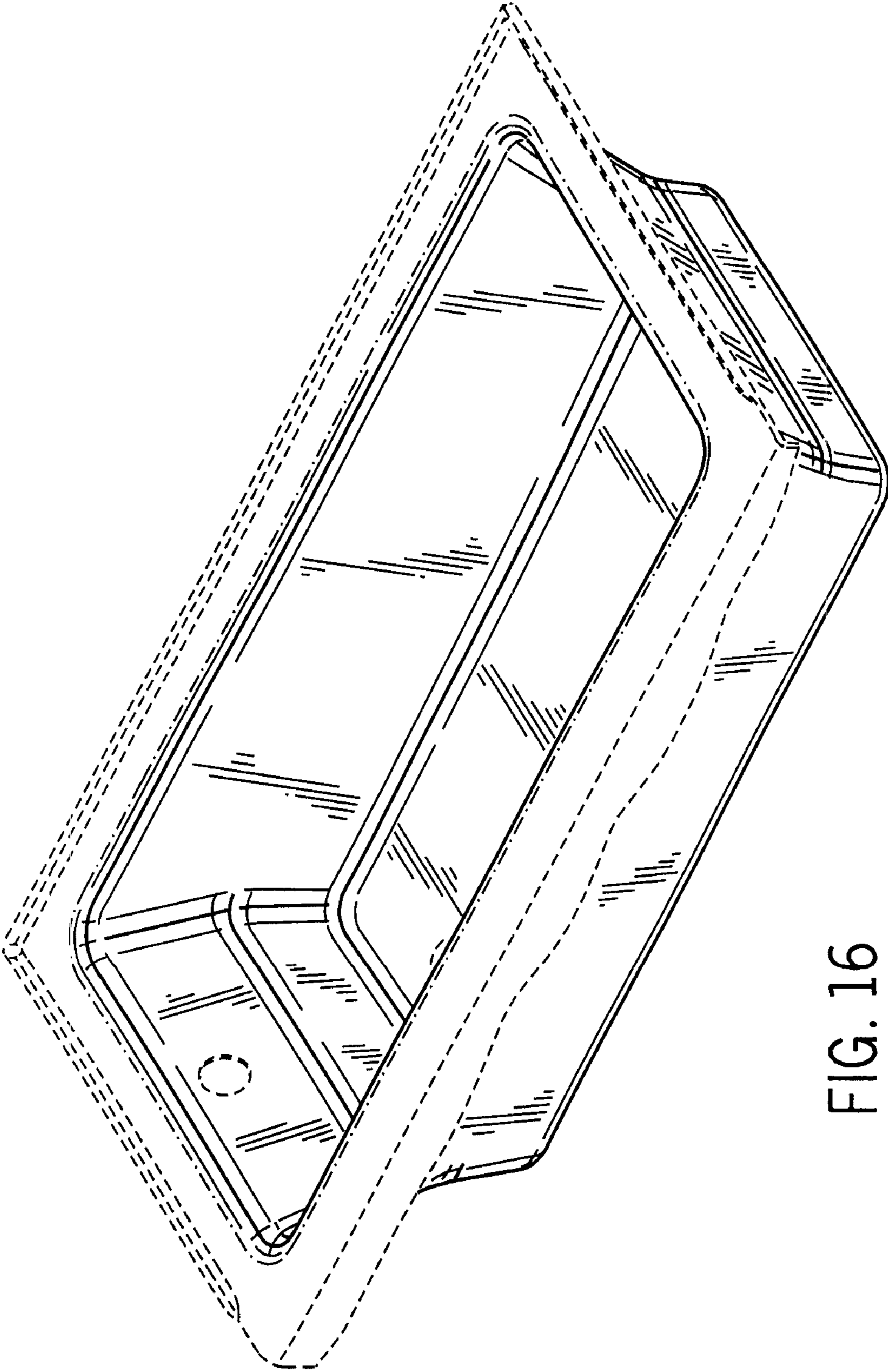

FIG. 16