

US00D595761S

(12) **United States Design Patent**
Plattard

(10) **Patent No.:** **US D595,761 S**

(45) **Date of Patent:** **** Jul. 7, 2009**

(54) **ELECTRONIC PIANO**

(75) Inventor: **Yves Plattard**, Hamamatsu (JP)

(73) Assignee: **Yamaha Corporation**, Hamamatsu-shi (JP)

(**) Term: **14 Years**

(21) Appl. No.: **29/325,900**

(22) Filed: **Oct. 8, 2008**

(30) **Foreign Application Priority Data**

Apr. 10, 2008 (JP) 2008-009223

(51) **LOC (9) Cl.** **17-01**

(52) **U.S. Cl.** **D17/1**

(58) **Field of Classification Search** D17/1,
D17/2, 7, 8; 84/13, 172, 174, 239, 240, 243,
84/423 R, 743, 744; D21/409

See application file for complete search history.

(56) **References Cited**

U.S. PATENT DOCUMENTS

1,853,728 A * 4/1932 Granstrom 84/404

D294,438 S * 3/1988 Page D6/397

D322,640 S * 12/1991 Billings D21/409

D345,372 S * 3/1994 Ida D17/7

D555,188 S * 11/2007 Saito D17/7

D555,714 S * 11/2007 Katsumata et al. D17/7

* cited by examiner

Primary Examiner—Ian Simmons

Assistant Examiner—R. Johnson

(74) *Attorney, Agent, or Firm*—Sughrue Mion, PLLC

(57) **CLAIM**

The ornamental design for an electronic piano, as shown and described.

DESCRIPTION

FIG. 1 is a front, top, left perspective view of an electronic piano showing my new design;

FIG. 2 is a top plan view thereof;

FIG. 3 is a front elevation view thereof;

FIG. 4 is a back elevation view thereof;

FIG. 5 is a left side view thereof;

FIG. 6 is a right side view thereof; and,

FIG. 7 is a bottom plan view thereof

1 Claim, 6 Drawing Sheets

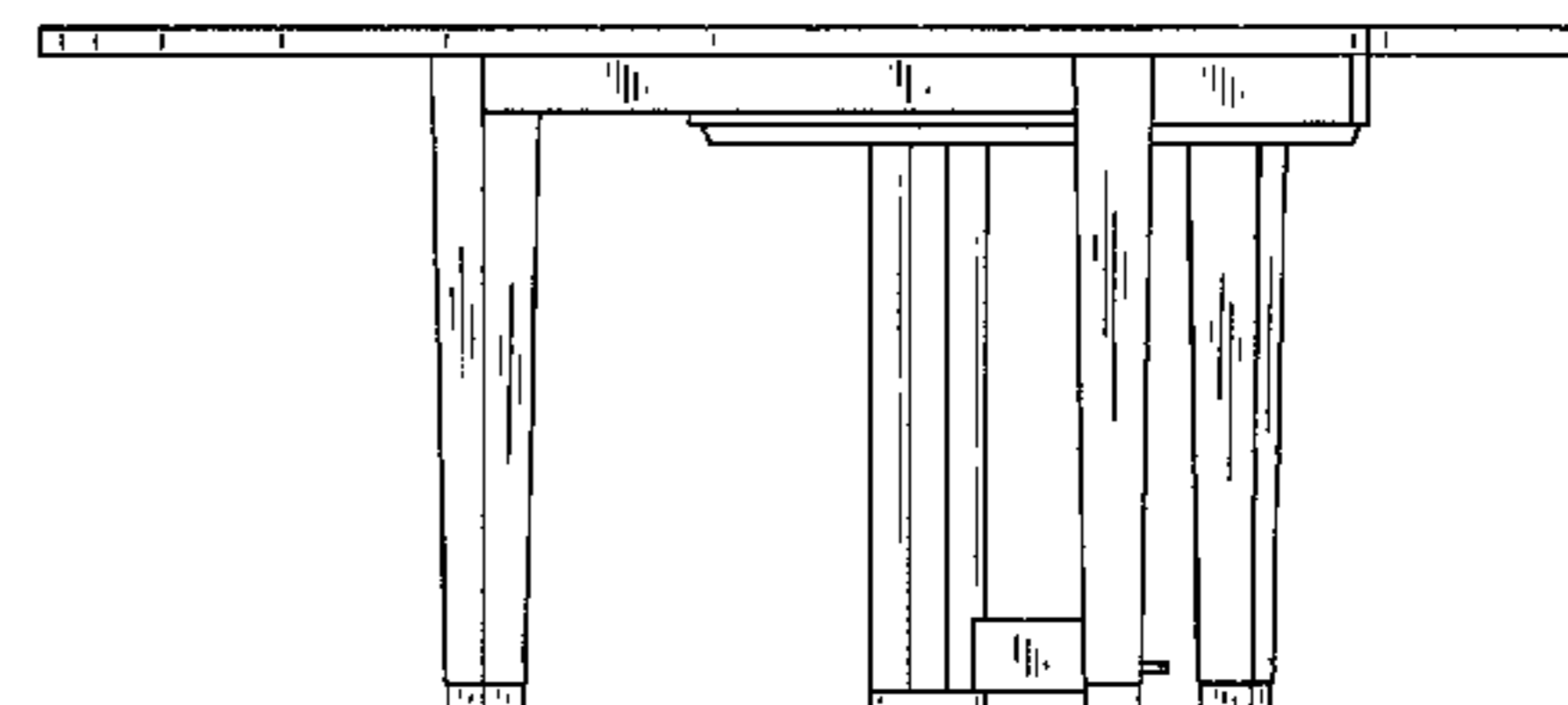
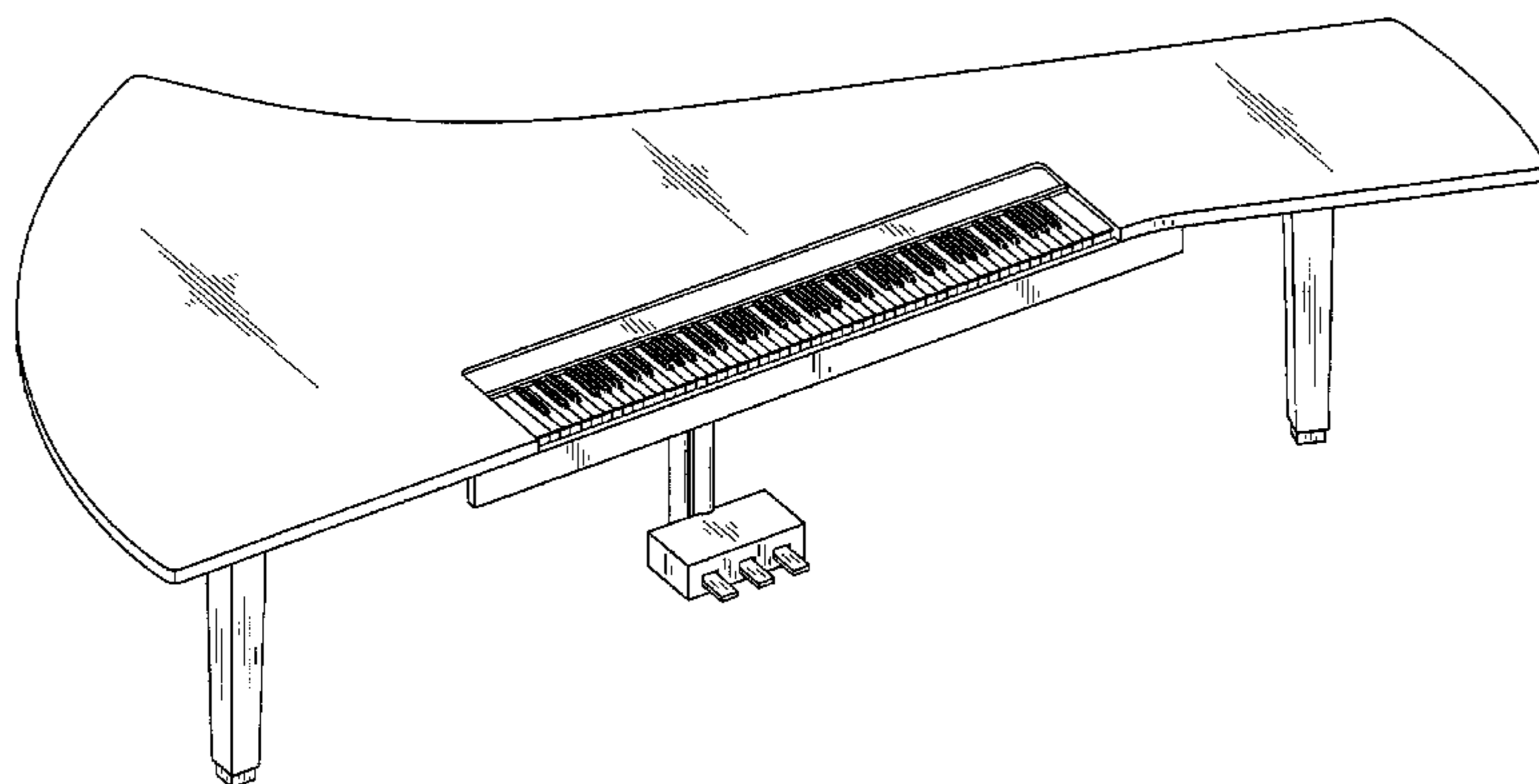

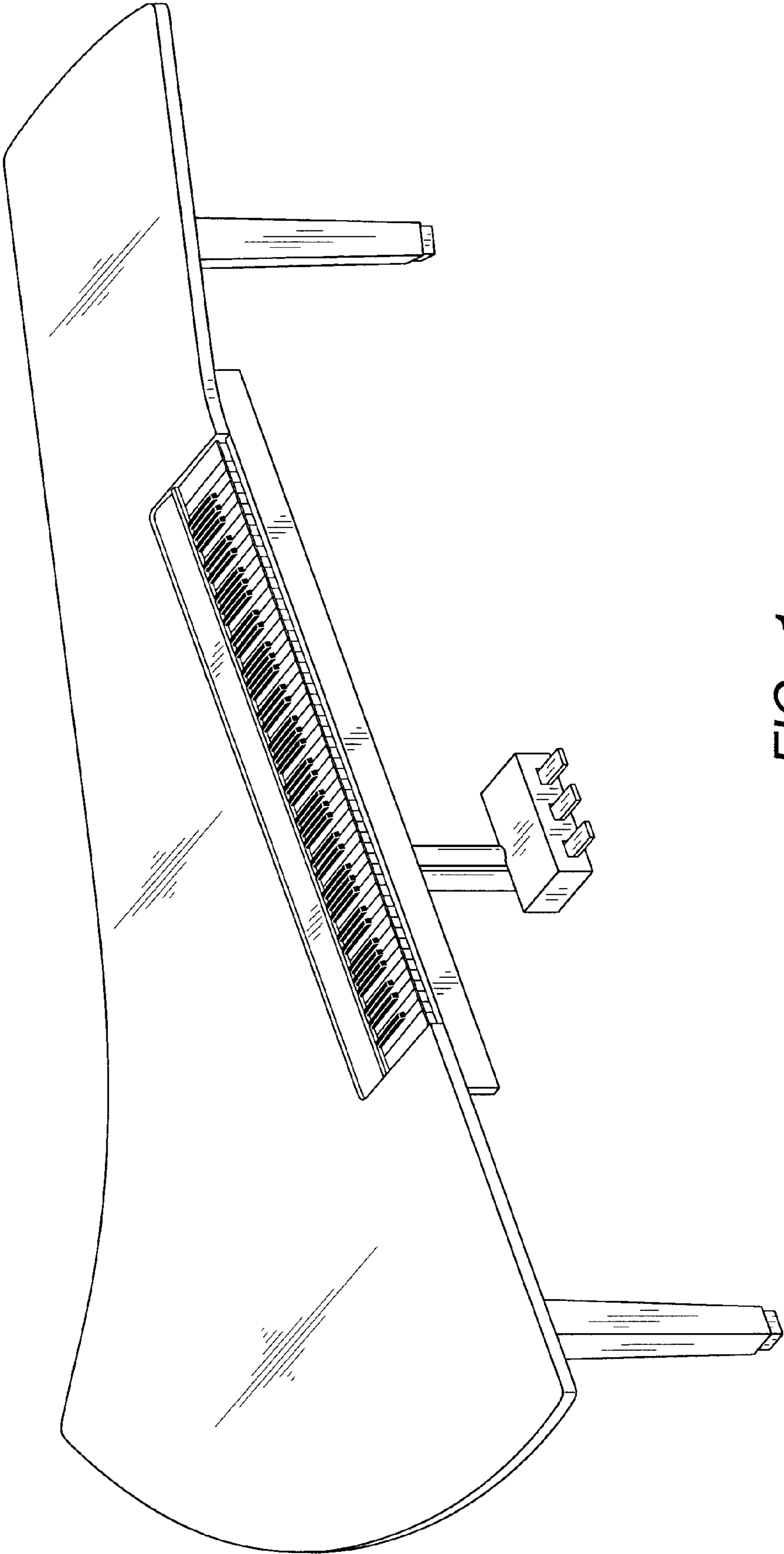

FIG. 1

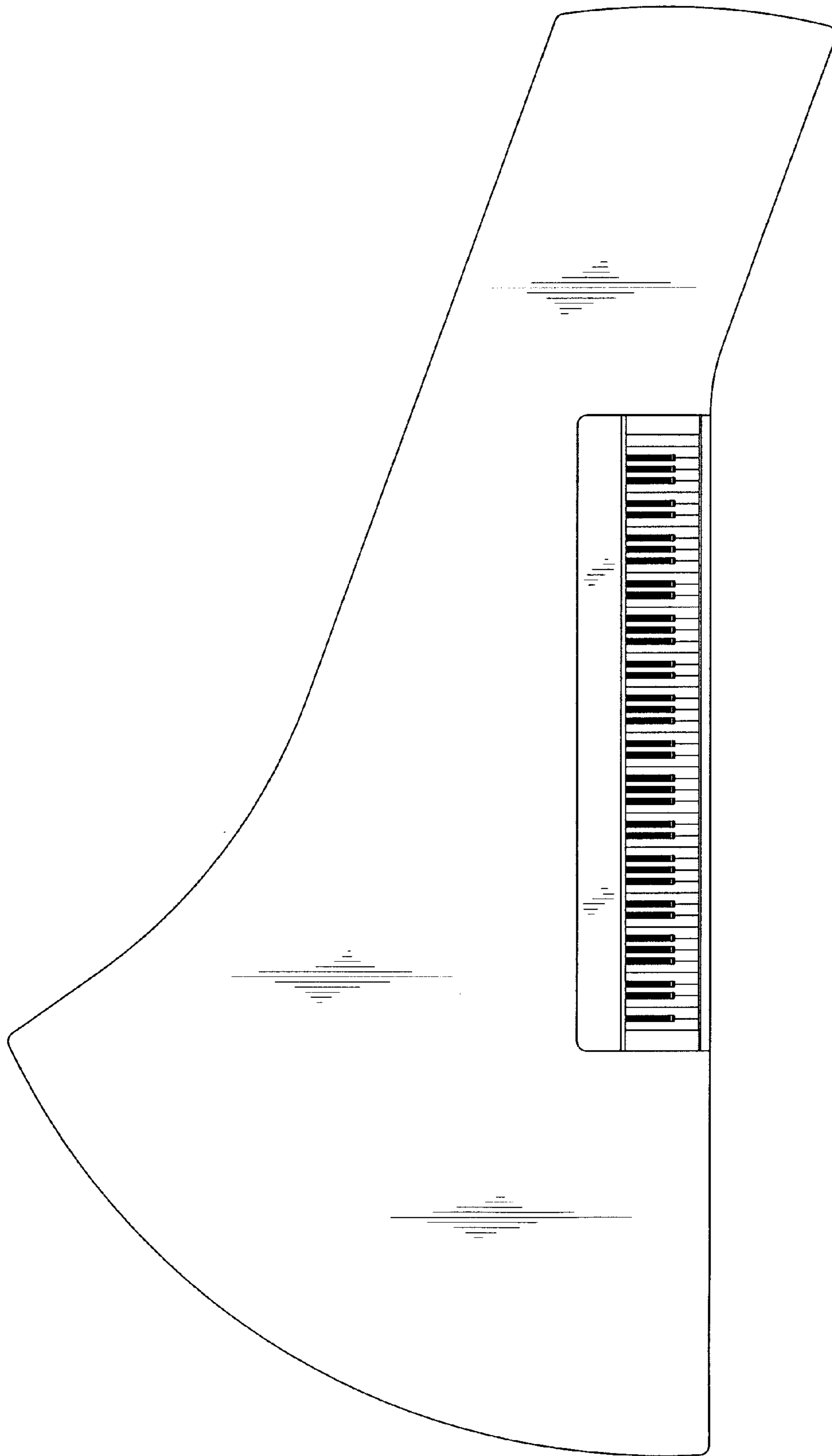

FIG. 2

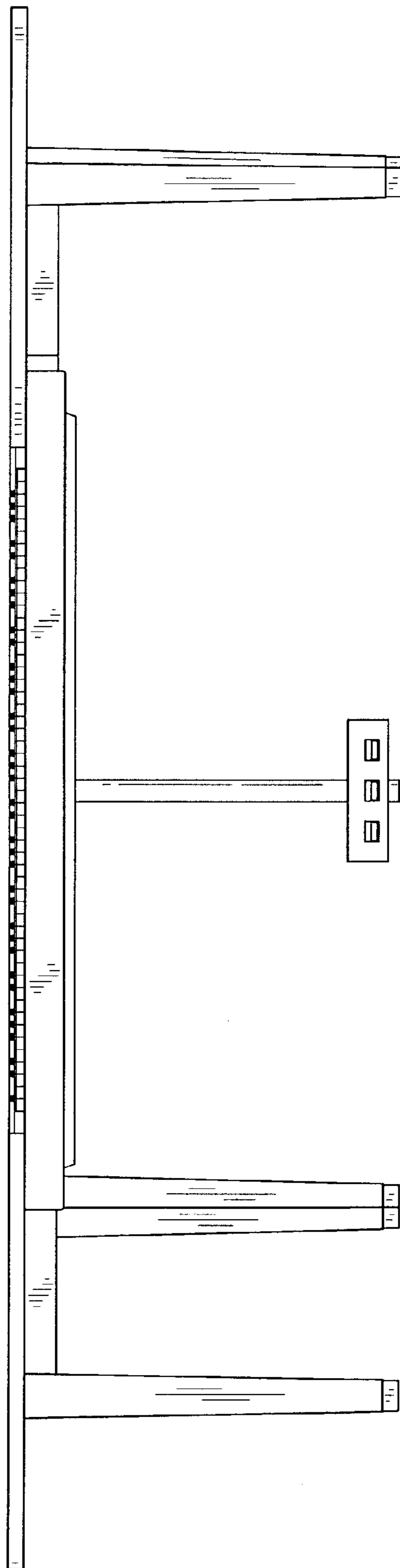

FIG. 3

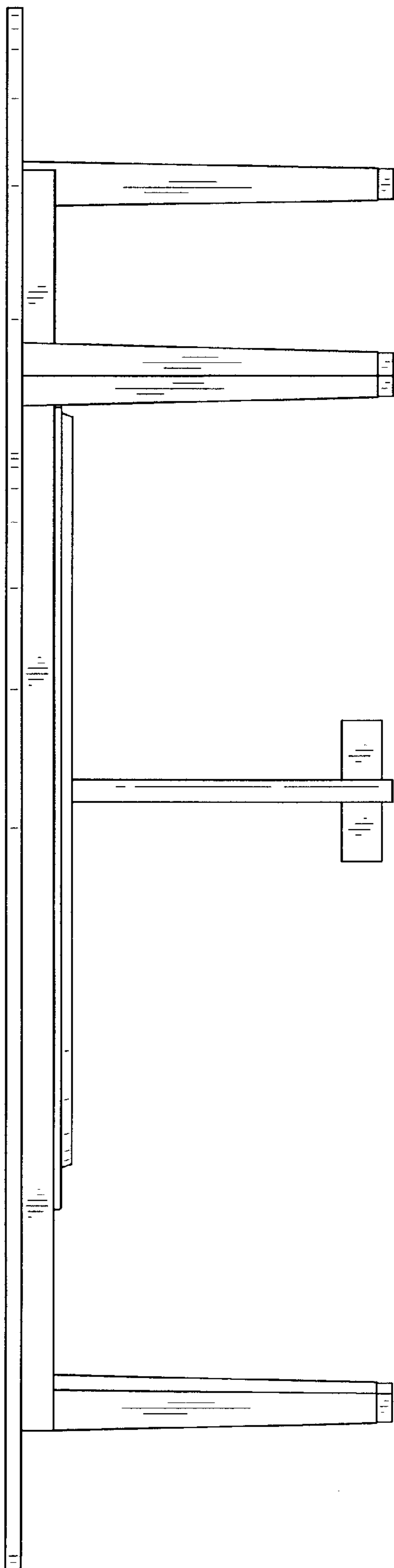

FIG. 4

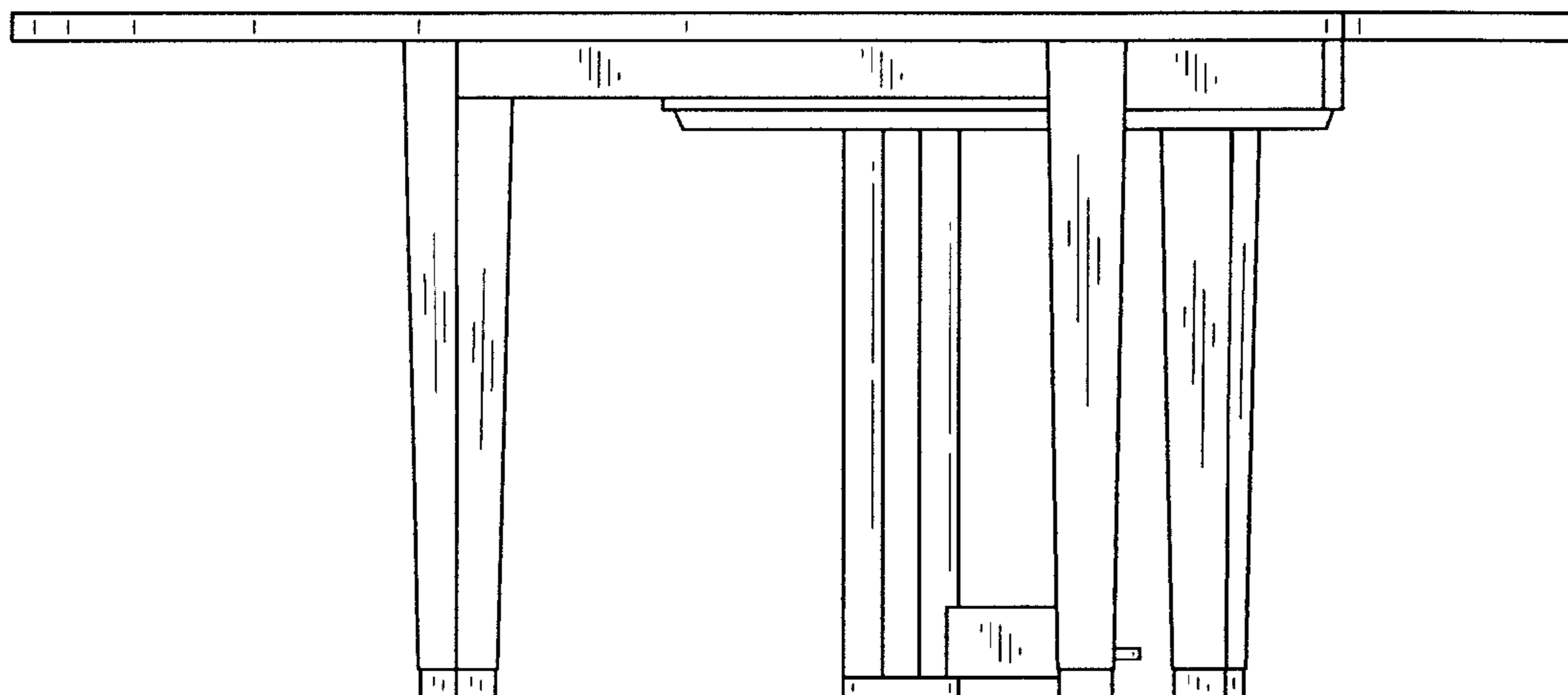

FIG. 5

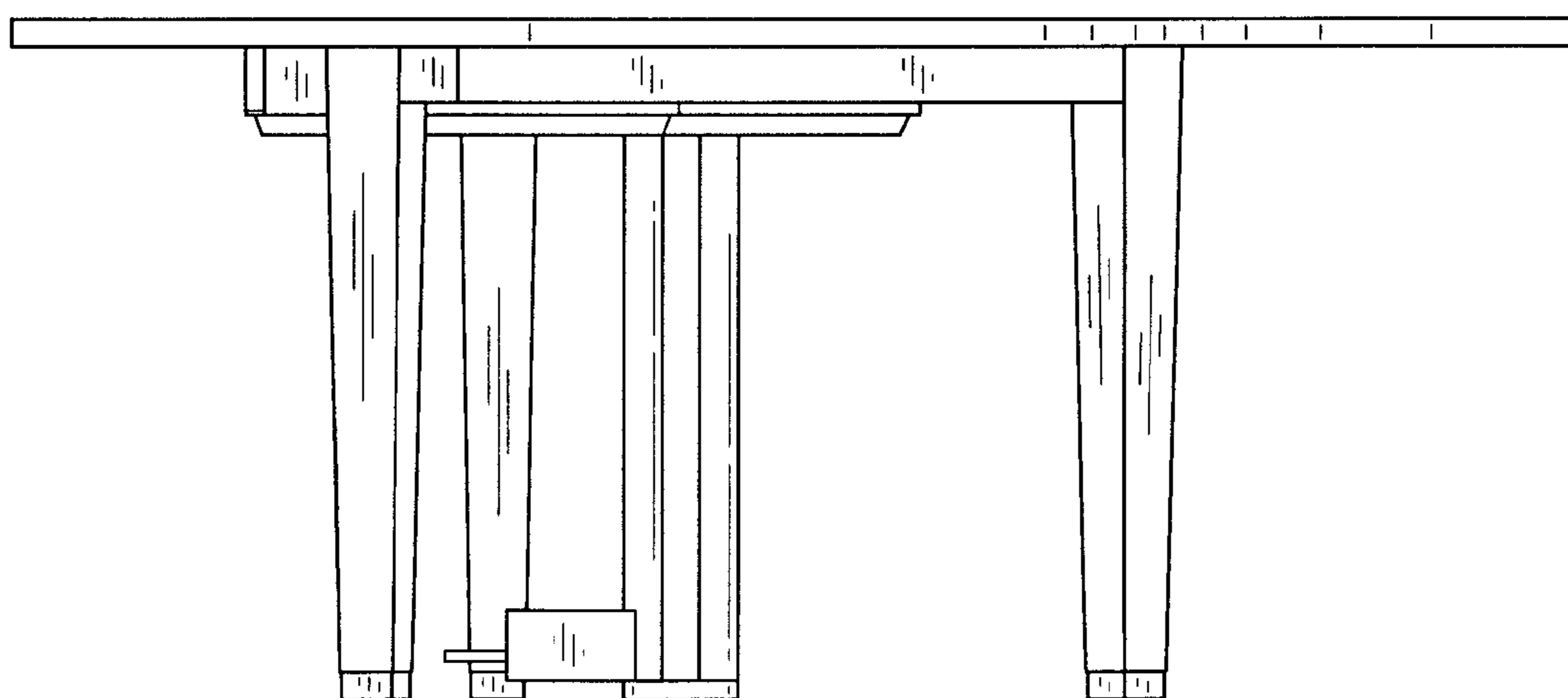

FIG. 6

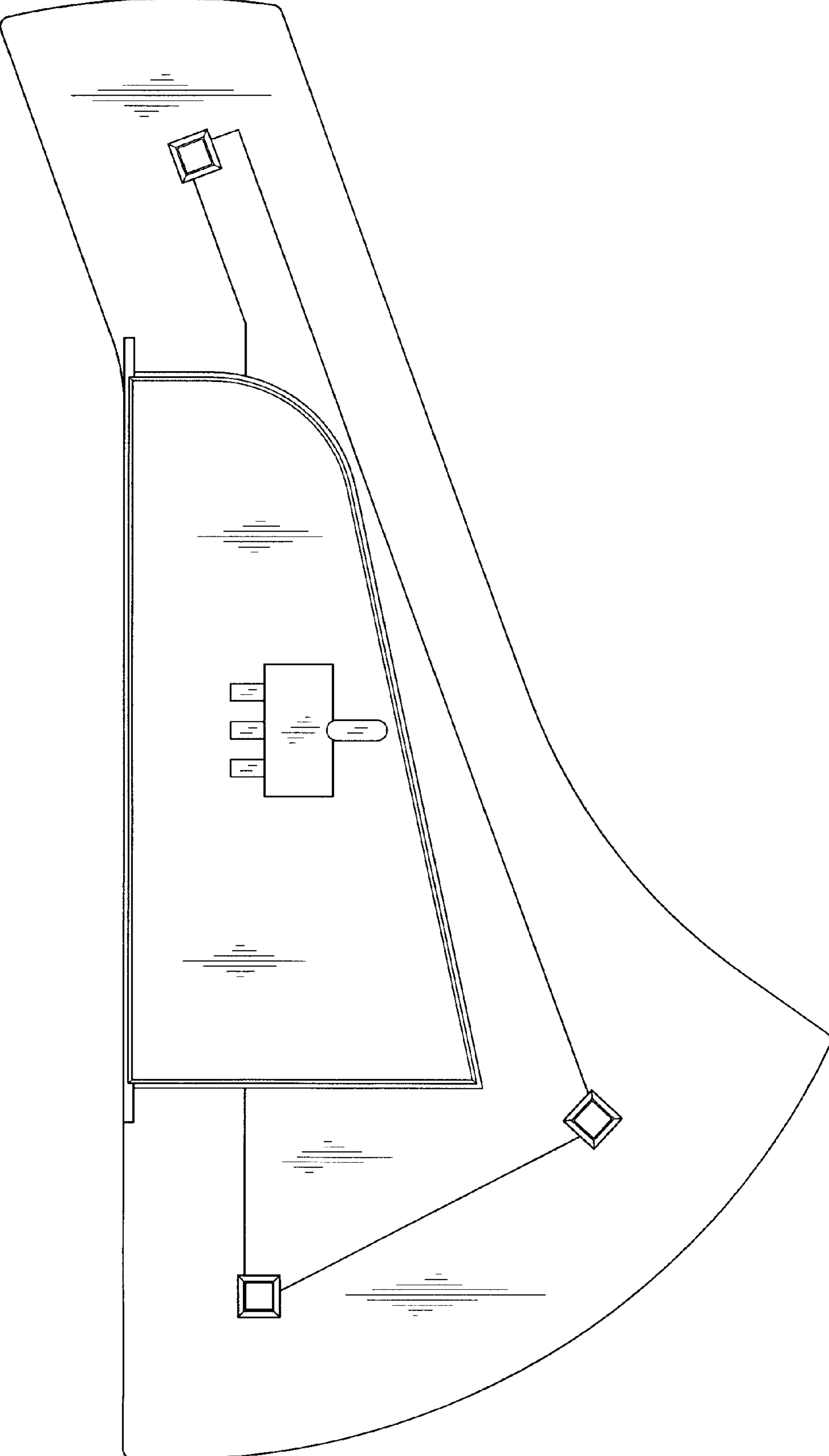

FIG. 7