

US00D595712S

(12) **United States Design Patent**
Guery et al.

(10) **Patent No.:** **US D595,712 S**
(45) **Date of Patent:** **** Jul. 7, 2009**

(54) **MOBILE INFORMATION TERMINAL**

(75) Inventors: **Ederm Guery**, Tokyo (JP); **Taihei Miyaji**, Tokyo (JP); **Katsuaki Shimizu**, Saitama-ken (JP)

(73) Assignee: **Kabushiki Kaisha Toshiba**, Tokyo (JP)

(**) Term: **14 Years**

(21) Appl. No.: **29/321,351**

(22) Filed: **Jul. 15, 2008**

(30) **Foreign Application Priority Data**

Feb. 8, 2008 (JP) 2008-002759

(51) **LOC (9) Cl.** **14-02**

(52) **U.S. Cl.** **D14/341**

(58) **Field of Classification Search** D14/496,
D14/401, 435, 474, 483, 217, 137, 138, 160,
D14/168, 203.1–203.8, 341–347, 138 R,
D14/138 C, 138 G, 454, 439, 455, 456, 192,
D14/239, 247, 315, 327, 331, 336, 338, 339,
D14/374, 393, 394, 399, 400, 429, 432, 125,
D14/126, 129, 130, 314; D21/324, 329,
D21/330, 331, 333; D18/7; D10/32; 455/556.1,
455/556.2, 11.1, 773, 344–347, 93, 95; 379/433.01,
379/433.07, 433.1, 433.11, 433.12, 433.13;
345/169, 156, 173–179, 905; 348/14.02,
348/790; 341/22; 361/680; 273/148 B;
368/281; 715/727–729, 864; 370/342–344;
369/1, 2, 6, 12; 463/43–47

See application file for complete search history.

(56) **References Cited**

U.S. PATENT DOCUMENTS

D270,061 S 8/1983 Ackeret
D270,062 S 8/1983 Ackeret
D270,063 S 8/1983 Ackeret
D333,574 S * 3/1993 Ackeret D6/300
D337,569 S * 7/1993 Kando D14/341
D346,793 S 5/1994 Iino et al.
D361,552 S 8/1995 Iino

D409,185 S 5/1999 Kawashima
D467,890 S 12/2002 Lai et al.
D490,420 S * 5/2004 Solomon et al. D14/341
D490,810 S * 6/2004 Huang D14/374
D504,889 S * 5/2005 Andre et al. D14/341
D529,045 S 9/2006 Shin
D532,791 S * 11/2006 Kim D14/203.7
D535,281 S * 1/2007 Yang D14/203.3
D536,329 S * 2/2007 Lee D14/203.6
D548,713 S 8/2007 Lee et al.
D550,174 S * 9/2007 Deguchi D14/126
D550,710 S 9/2007 Ichinose
D552,580 S 10/2007 Mun
D554,098 S 10/2007 Lee

(Continued)

FOREIGN PATENT DOCUMENTS

JP 971556 1/1997

(Continued)

Primary Examiner—Cathron C Brooks
Assistant Examiner—Barbara Fox
(74) *Attorney, Agent, or Firm*—Banner & Witcoff, Ltd.

(57) **CLAIM**

The ornamental design for a mobile information terminal, as shown and described.

DESCRIPTION

FIG. 1 is a bottom, front and left side perspective view a mobile information terminal showing our new design,
FIG. 2 is a front elevational view thereof,
FIG. 3 is a rear elevational view thereof,
FIG. 4 is a left side elevational view thereof,
FIG. 5 is a right side elevational view thereof,
FIG. 6 is a top plan view thereof; and,
FIG. 7 is a bottom plan view thereof.

1 Claim, 3 Drawing Sheets

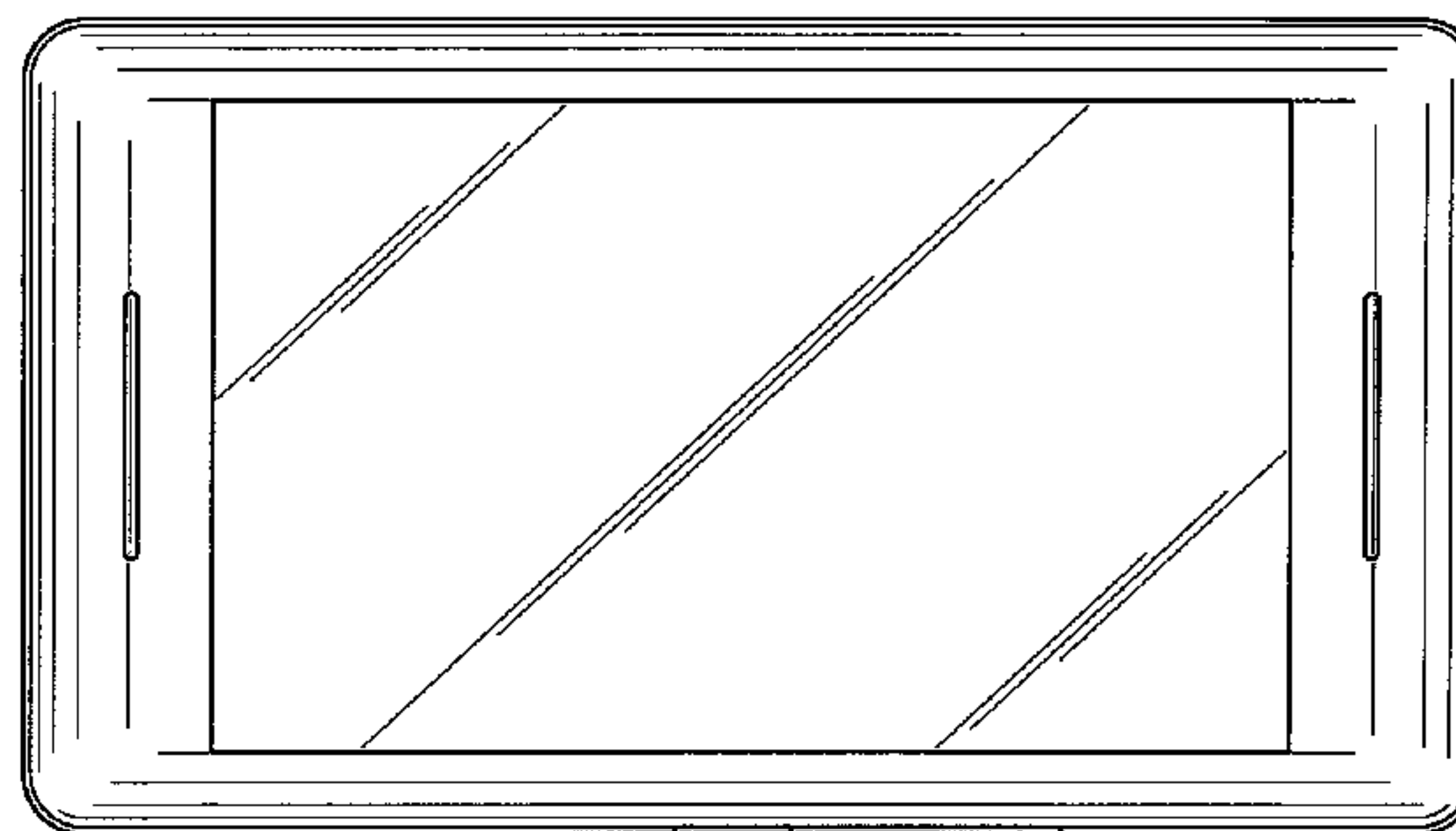
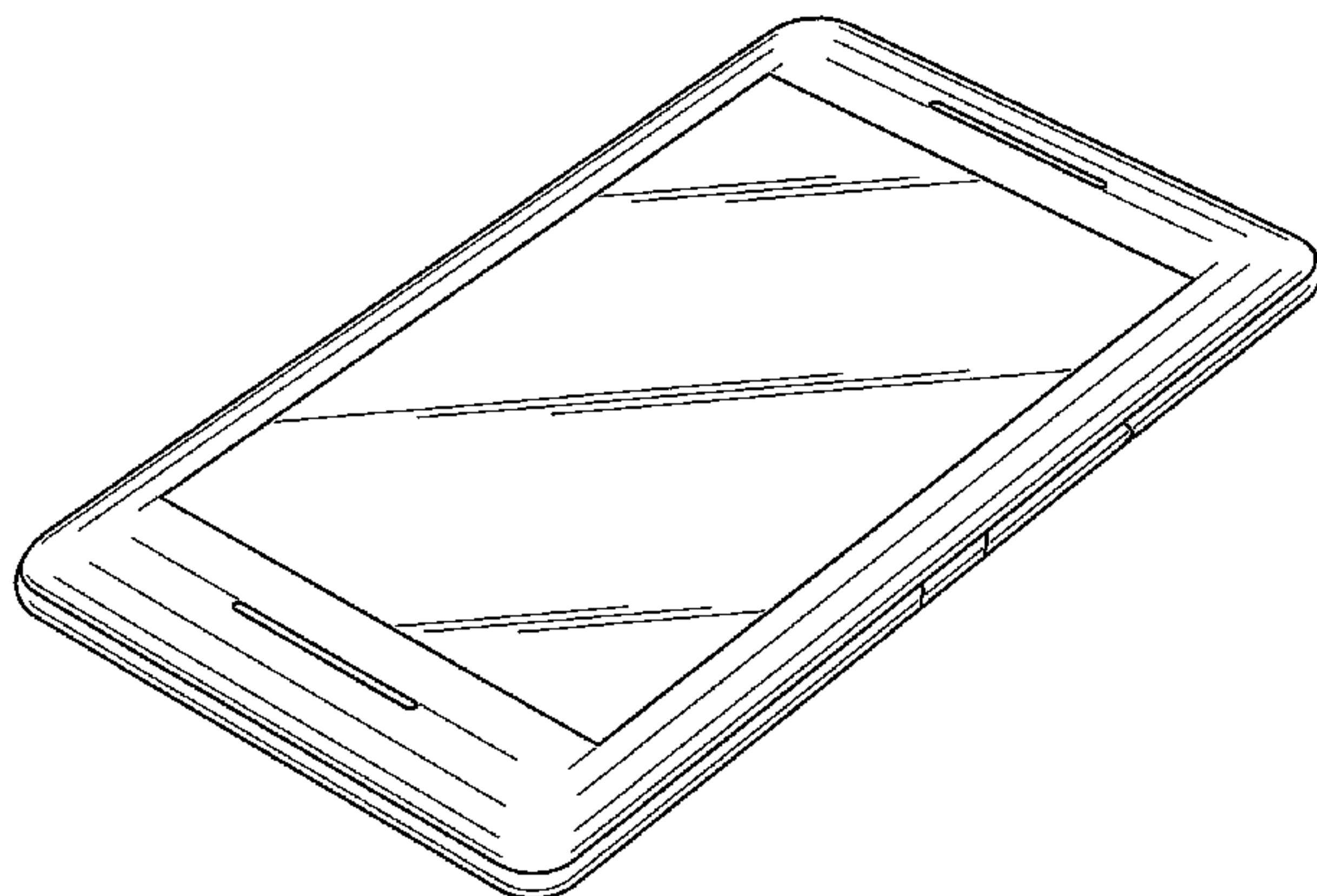

US D595,712 S

Page 2

U.S. PATENT DOCUMENTS

D554,099 S 10/2007 Kim et al.
D556,211 S 11/2007 Howard
D558,460 S * 1/2008 Yu et al. D6/308
D558,756 S 1/2008 Andre et al.
D558,757 S 1/2008 Andre et al.
D558,758 S 1/2008 Andre et al.
D560,227 S * 1/2008 Bennett et al. D14/496
D560,231 S * 1/2008 Lee D14/496
D562,285 S 2/2008 Lim
D562,292 S 2/2008 Park
D562,589 S * 2/2008 Mellon D6/449
D563,938 S 3/2008 Kim et al.
D565,596 S 4/2008 Kim
D567,819 S 4/2008 Devericks et al.
D569,629 S * 5/2008 Yu et al. D6/308
D569,837 S * 5/2008 Baik et al. D14/138 G
D570,321 S 6/2008 Choi et al.

D572,266 S 7/2008 Anderson et al.
D573,143 S 7/2008 Park et al.
D575,259 S 8/2008 Kim et al.
D577,703 S * 9/2008 Lee et al. D14/138 G
D578,501 S * 10/2008 Seo et al. D14/138 AB
D579,930 S * 11/2008 Maskatia D14/341
D582,917 S * 12/2008 Wada D14/371
D583,342 S * 12/2008 Kim et al. D14/138 G
D584,738 S * 1/2009 Kim et al. D14/496
D587,267 S * 2/2009 Wang D14/356

FOREIGN PATENT DOCUMENTS

JP D1126962 11/2001
JP D1241383 6/2005
JP 2007-025759 9/2007
KR 30-0441230-3 8/2007

* cited by examiner

FIG. 1

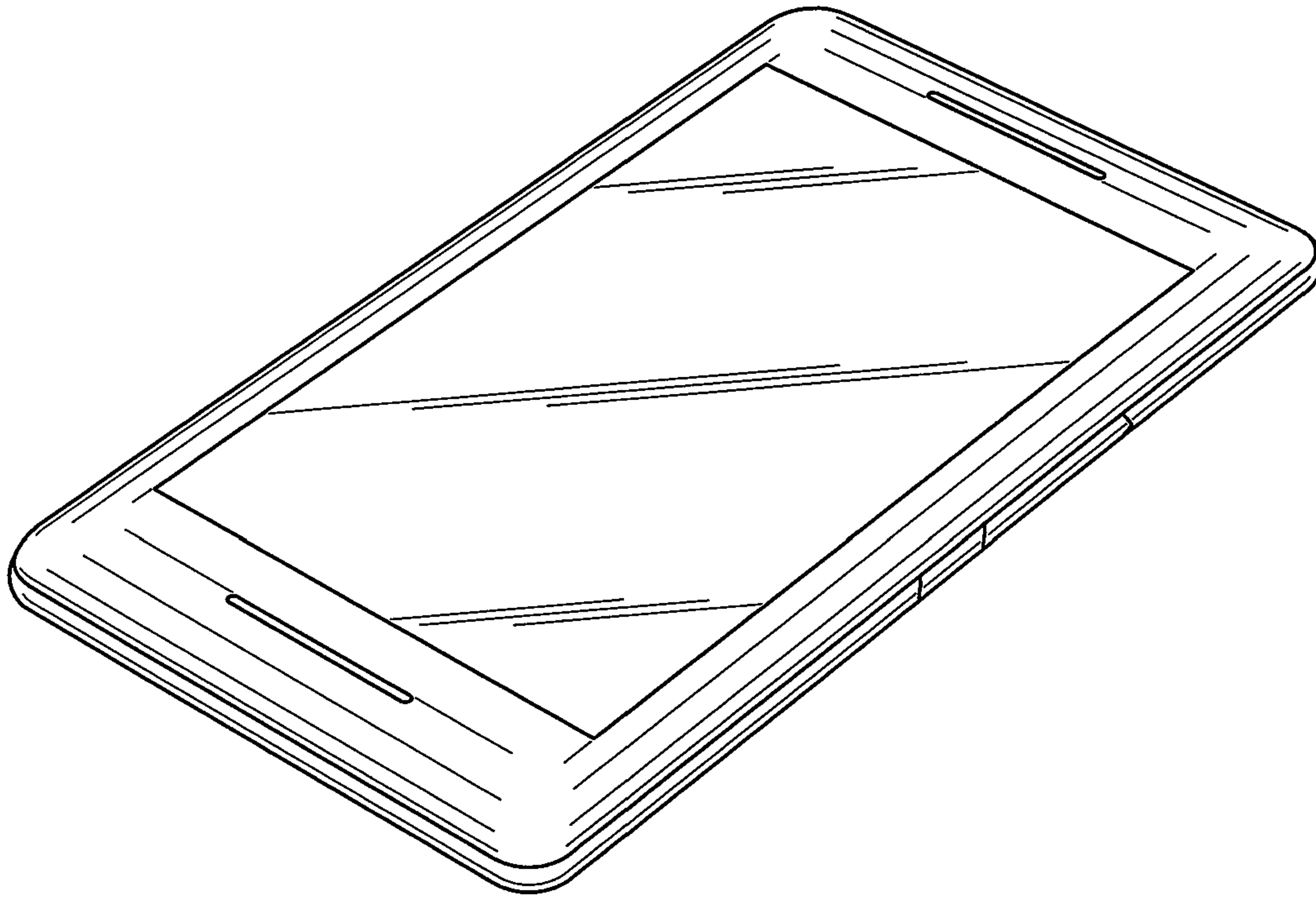

FIG. 2

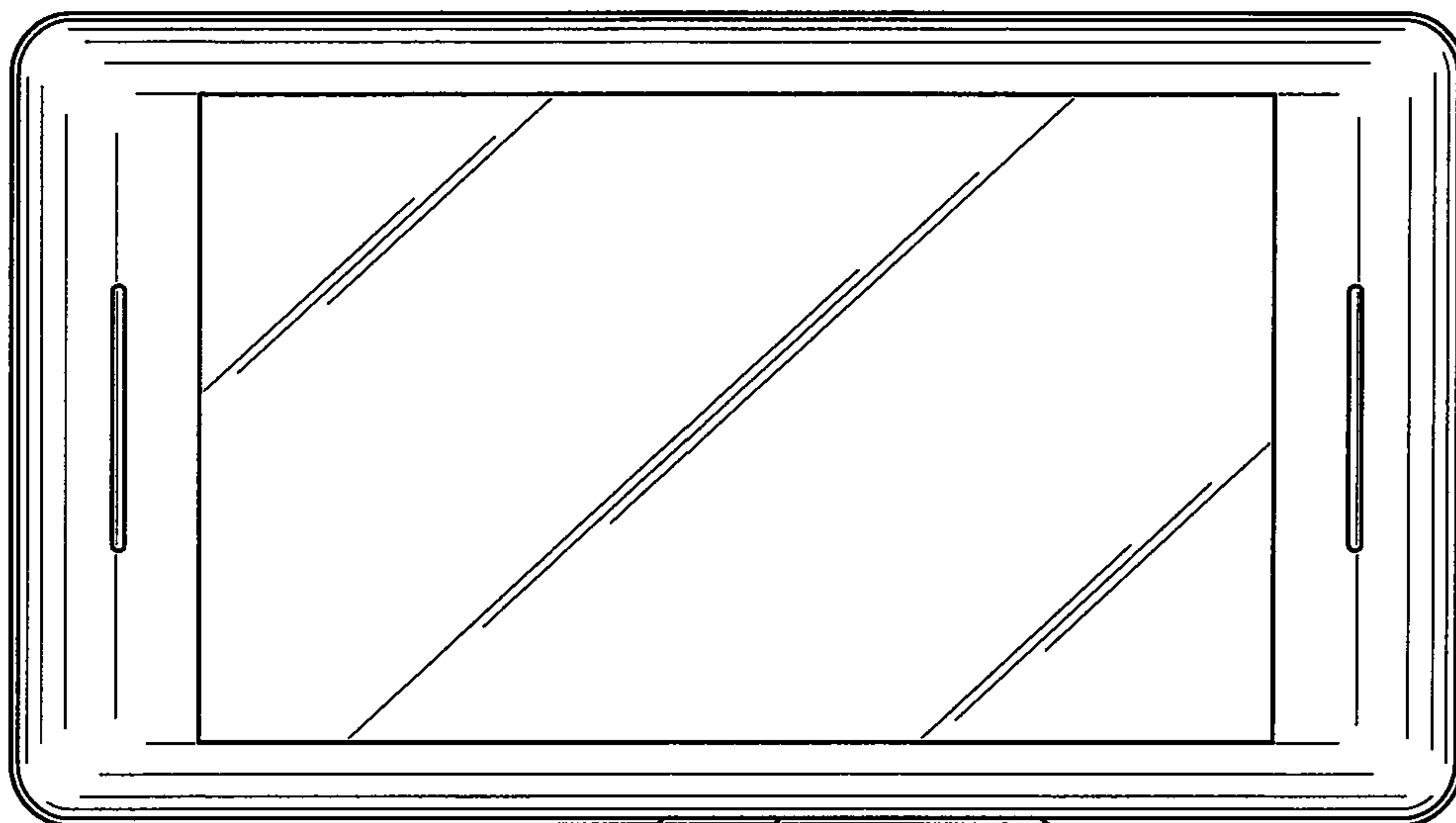

FIG. 3

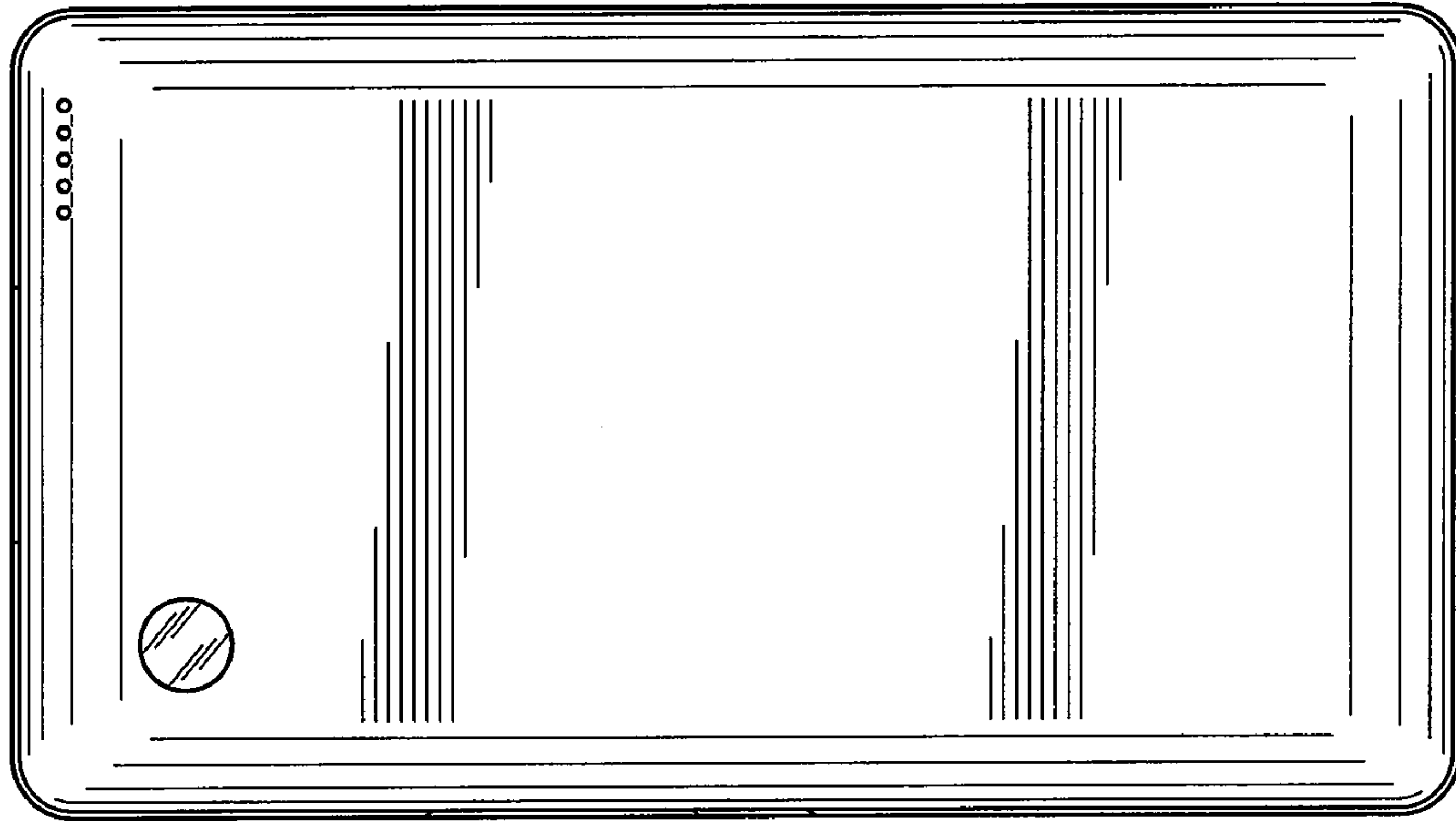

FIG. 4

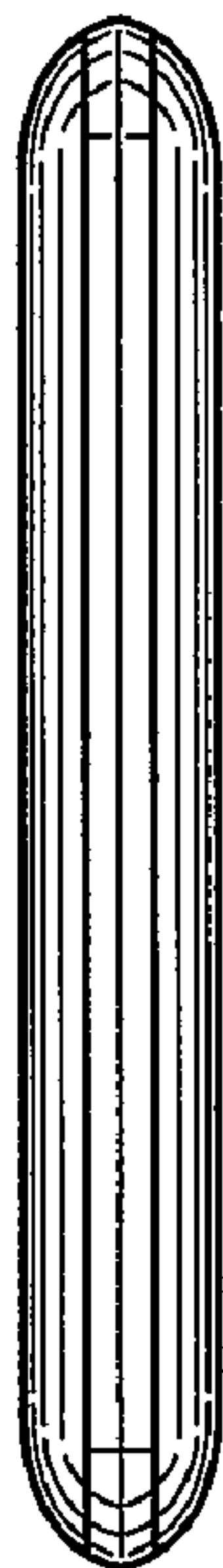

FIG. 5



FIG. 6

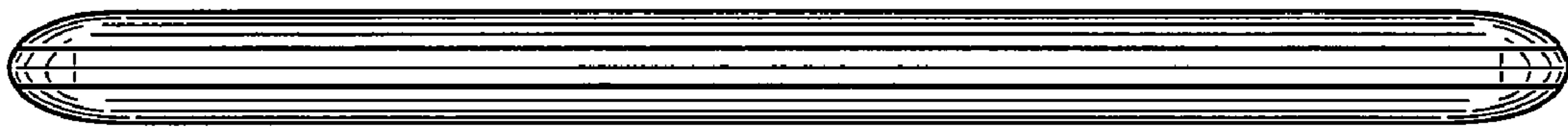

FIG. 7

