

US00D595706S

(12) **United States Design Patent**
Tomasso et al.

(10) **Patent No.:** **US D595,706 S**
(45) **Date of Patent:** **** Jul. 7, 2009**

(54) **HANDHELD ELECTRONIC COMMUNICATIONS DEVICE**

6,452,588 B2 9/2002 Griffin et al. 345/169

(75) Inventors: **Keir Tomasso**, Sewell, NJ (US); **Joseph E. D'Ottavi**, Haddon Township, NJ (US)

(Continued)

(73) Assignee: **L-3 Communications Corporation**, New York, NY (US)

OTHER PUBLICATIONS

Motorola Q 8, announced Jul. 2005, <URL:http://www.gsmarena.com/motorola_q_8-pictures-1232.php>, retrieved from internet Aug. 9, 2008 9:31:05 PM.*

(**) Term: **14 Years**

(Continued)

(21) Appl. No.: **29/299,823**

(22) Filed: **Jan. 4, 2008**

Primary Examiner—Ian Simmons
Assistant Examiner—Carla Jobe Wright
(74) *Attorney, Agent, or Firm*—Woodcock Washburn LLP

Related U.S. Application Data

(63) Continuation of application No. 29/279,069, filed on Apr. 19, 2007, now Pat. No. Des. 563,402.

(57) **CLAIM**

We claim the ornamental design for a handheld electronic communications device, as shown and described.

(51) **LOC (9) Cl.** **14-03**

(52) **U.S. Cl.** **D14/247**

(58) **Field of Classification Search** D14/137–138, D14/147–148, 156, 218, 247–248, 341–347, D14/390, 399, 455–456, 496; D13/164, D13/168; D21/329, 331, 333, 517; 341/22; 343/702; 348/14.01–14.02; 361/814; 379/433.01–433.13; 439/165; 455/90.3, 553.1, 556.1–556.2, 455/566, 575.1, 575.3, 575.4

See application file for complete search history.

DESCRIPTION

The subject matter disclosed and claimed herein is related to the subject matter disclosed and claimed in U.S. patent application Ser. No. 29/279,068, now U.S. Design patent No. D563,401, filed on April 19, 2007.

FIG. 1 is a rear perspective view of a handheld electronic communications device showing our new design.

FIG. 2 is a front perspective view thereof.

FIG. 3 is a left side view thereof.

FIG. 4 is a front view thereof.

FIG. 5 is a right side view thereof.

FIG. 6 is a rear view thereof.

FIG. 7 is a bottom view thereof; and,

FIG. 8 is a top view thereof.

The portions of the handheld electronic communication device illustrated in broken line are not part of the claimed design.

(56) **References Cited**

U.S. PATENT DOCUMENTS

5,500,643 A *	3/1996	Grant	341/22
D416,256 S	11/1999	Griffin et al.	D14/191
D433,460 S	11/2000	Griffin et al.	D21/329
D436,591 S	1/2001	Abston et al.	D14/341
6,278,442 B1	8/2001	Griffin et al.	345/169
D454,349 S	3/2002	Makidera et al.	D14/343
6,396,482 B1	5/2002	Griffin et al.	345/169
D460,493 S	7/2002	Griffin et al.	D21/329
D461,803 S	8/2002	Griffin et al.	D14/346
D462,958 S	9/2002	Nguyen et al.	D14/343
D463,422 S	9/2002	Webb	D14/343
D463,423 S	9/2002	Webb	D14/343

1 Claim, 5 Drawing Sheets

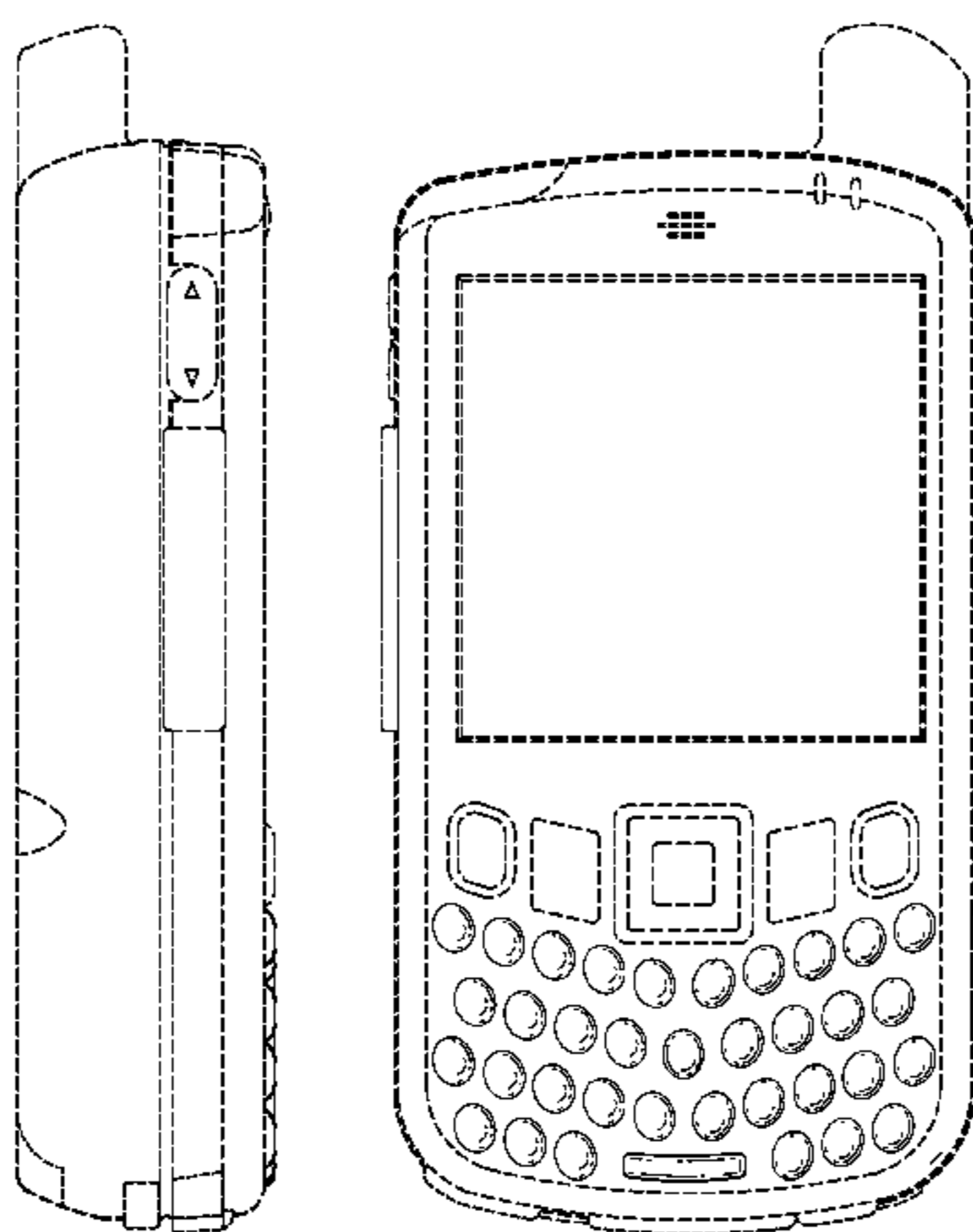

US D595,706 S

Page 2

U.S. PATENT DOCUMENTS

D464,962 S	10/2002	MacGregor et al.	D14/346	D537,082 S	2/2007	Griffin	D14/455
D464,995 S	10/2002	Griffin et al.	D21/329	D541,288 S	4/2007	Lam et al.	D14/455
D466,116 S *	11/2002	Bhatia et al.	D14/346	D550,641 S	9/2007	Wang	D14/138
6,489,950 B1	12/2002	Griffin et al.	345/168	D559,223 S *	1/2008	Kim et al.	D14/138
D470,842 S	2/2003	Bhatia et al.	D14/346	D561,723 S *	2/2008	Kim et al.	D14/138
D472,225 S	3/2003	Griffin	D14/138	D563,378 S *	3/2008	Tseng et al.	D14/138
D472,551 S	4/2003	Griffin	D14/346	D563,417 S *	3/2008	Lam et al.	D14/455
D477,596 S	7/2003	Hayes	D14/343	D566,110 S *	4/2008	Park et al.	D14/247
D478,585 S	8/2003	Griffin	D14/346	2005/0054376 A1 *	3/2005	Griffin et al.	455/553.1
6,611,254 B1	8/2003	Griffin et al.	345/169	2006/0033704 A1	2/2006	Ladouceur et al.	345/156
6,611,255 B2	8/2003	Griffin et al.	345/169	2006/0052145 A1 *	3/2006	Go	455/575.1
D479,233 S	9/2003	Griffin	D14/346	2006/0176279 A1	8/2006	Bersenev et al.	345/169
D484,878 S *	1/2004	Wightman et al.	D14/346	2006/0258326 A1	11/2006	Webb	455/350
D490,076 S	5/2004	Griffin	D14/346	2006/0264232 A1	11/2006	Fyke et al.	455/550.1
D490,119 S	5/2004	Griffin et al.	D21/329	2006/0264237 A1	11/2006	Rose et al.	455/557
D490,422 S	5/2004	Iwama et al.	D14/346	2007/0046638 A1	3/2007	Bumiller	345/169
D496,654 S *	9/2004	Burroughs	D14/247				
D496,933 S	10/2004	Wu	D14/346				
D497,907 S	11/2004	Griffin	D14/346				
D502,159 S	2/2005	Chan et al.	D14/138				
6,867,763 B2	3/2005	Griffin et al.	345/168				
6,873,317 B1	3/2005	Griffin et al.	345/168				
6,891,529 B2	5/2005	Ladouceur et al.	345/169				
D507,268 S	7/2005	Schlieffers et al.	D14/346				
D514,571 S	2/2006	Hawkins et al.	D14/391				
D515,093 S	2/2006	Hawkins et al.	D14/392				
D518,820 S	4/2006	Hawkins et al.	D14/346				
D518,821 S	4/2006	Hawkins et al.	D14/346				
D518,825 S	4/2006	Hawkins et al.	D14/392				
D519,502 S	4/2006	Hawkins et al.	D14/346				
D525,263 S	7/2006	Hawkins et al.	D14/456				
7,073,964 B2	7/2006	Griffin et al.	400/486				
D525,970 S	8/2006	Rak et al.	D14/346				
D529,024 S	9/2006	Daw et al.	D14/346				
7,103,432 B2	9/2006	Drader et al.	700/95				
7,113,111 B2	9/2006	Tyneski et al.	341/20				
D531,609 S	11/2006	Kim et al.	D14/138				
7,133,707 B1	11/2006	Rak et al.	455/575.1				
D533,173 S *	12/2006	Lee et al.	D14/247				
7,153,049 B2	12/2006	Pletikosa	400/472				

OTHER PUBLICATIONS

Palm Treo 600, announced 4Q 2003, <URL:http://www.gsmarena.com/palm_treo_600-pictures-622.php>, retrieved from internet Aug. 9, 2008 9:41:41 PM.*

Fujitsu Siemens T830, announced Aug. 2006, <URL:http://www.gsmarena.com/fujitsu_siemens_t830-pictures-1954.php>, retrieved from internet Aug. 9, 2008 9:48:31 PM.*

Motorola Q 9h, announced Feb. 2007, www.gsmarena.com. Retrieved from internet Sep. 17, 2007.

HTC S620, announced Sep. 2006, www.gsmarena.com, retrieved from internet Sep. 17, 2007.

Amoi E78, announced 2007, www.gsmarena.com, retrieved from internet Sep. 17, 2007.

Palm Treo 500v, announced Sep. 2007, www.gsmarena.com, retrieved from internet Sep. 17, 2007.

HP iPAW hw6515, announced 2Q 2005, www.gsmarena.com, retrieved from internet Sep. 17, 2007.

Fujitsu Siemens T810, announced Aug. 2006, www.gsmarena.com, retrieved from internet Sep. 17, 2007.

BenQ—Siemens P51, announced Mar. 2006, www.gsmarena.com, retrieved from internet Sep. 17, 2007.

BlackBerry Curve 8300, announced May 2007, www.gsmarena.com, retrieved from internet Sep. 17, 2007.

* cited by examiner

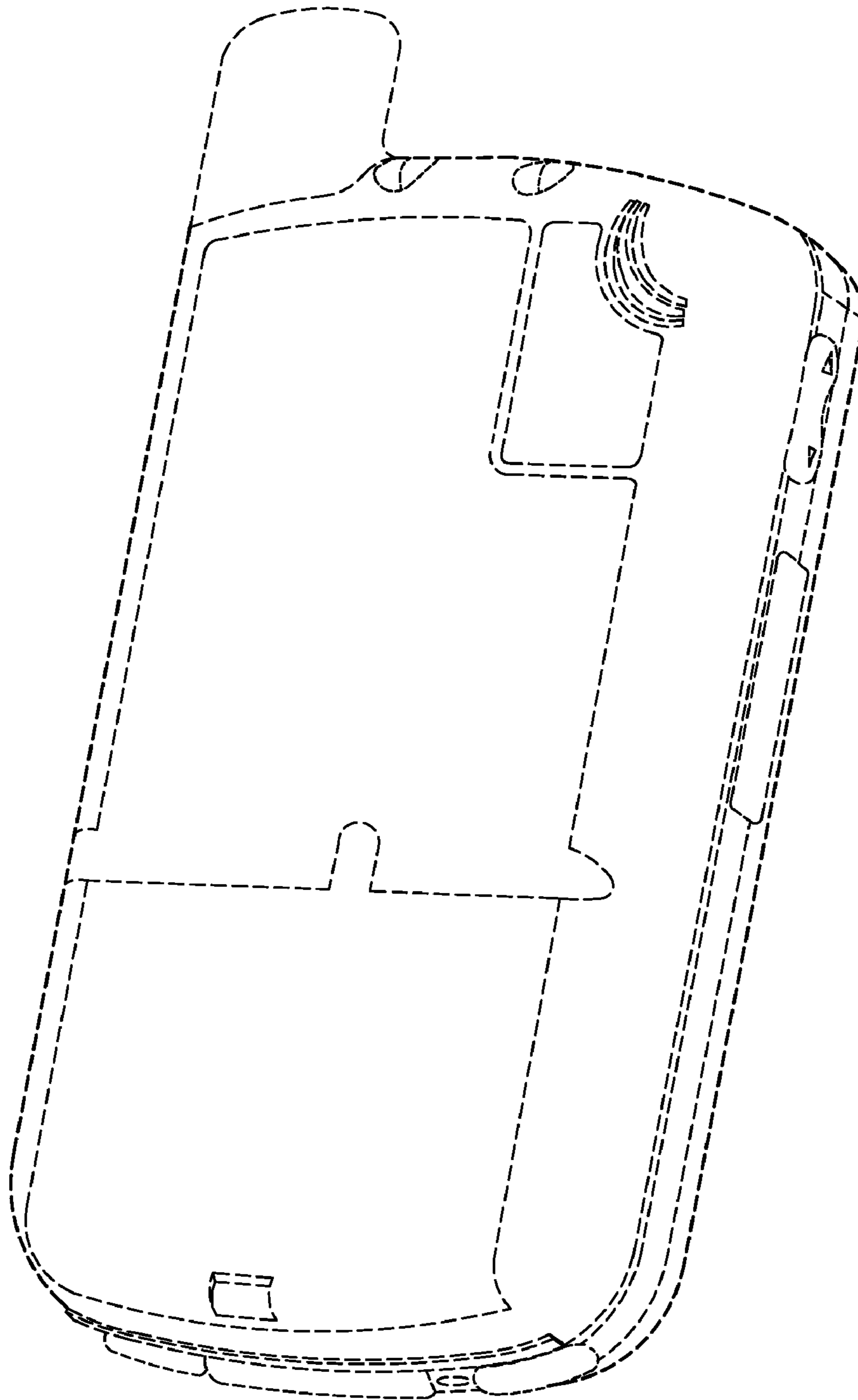

FIG. 1

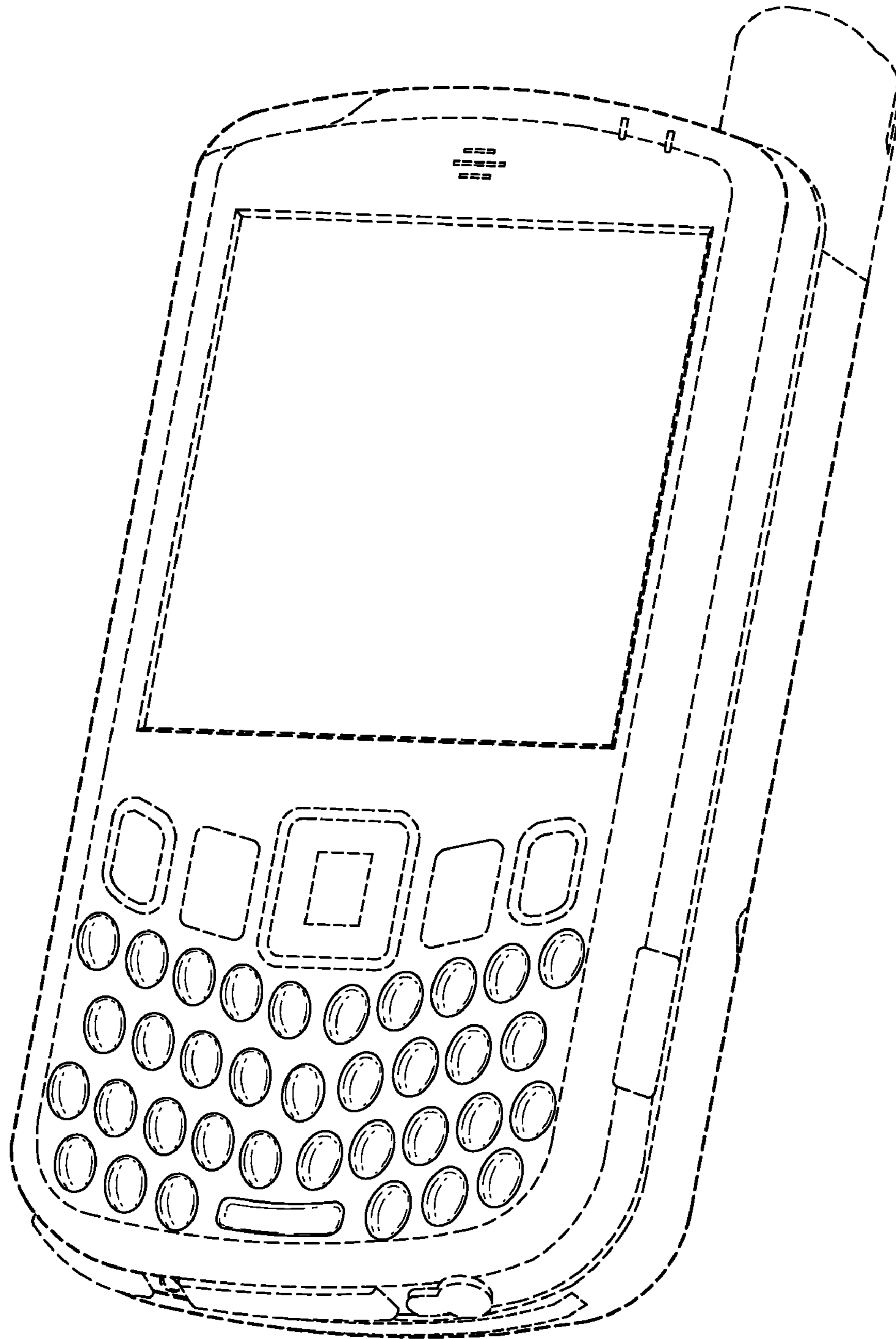

FIG. 2

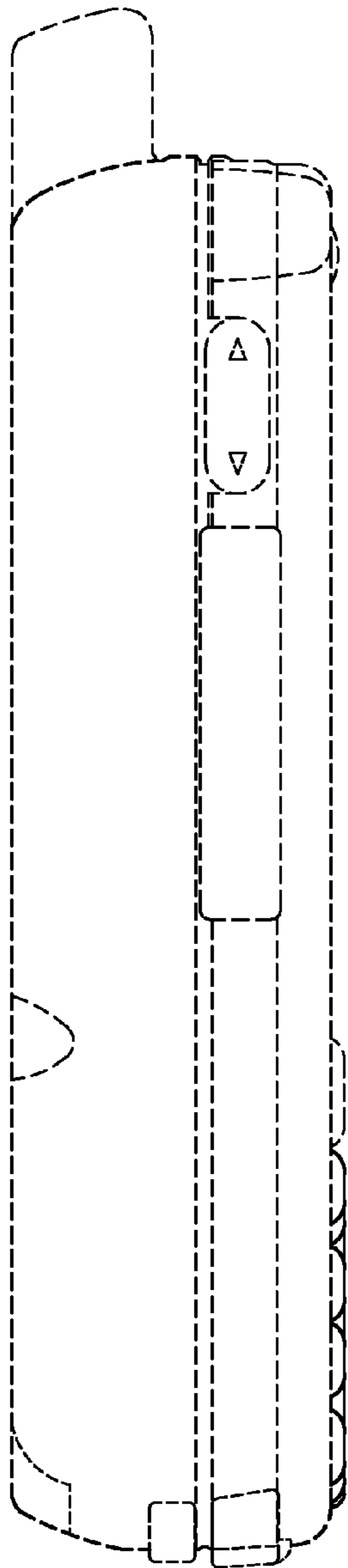

FIG. 3

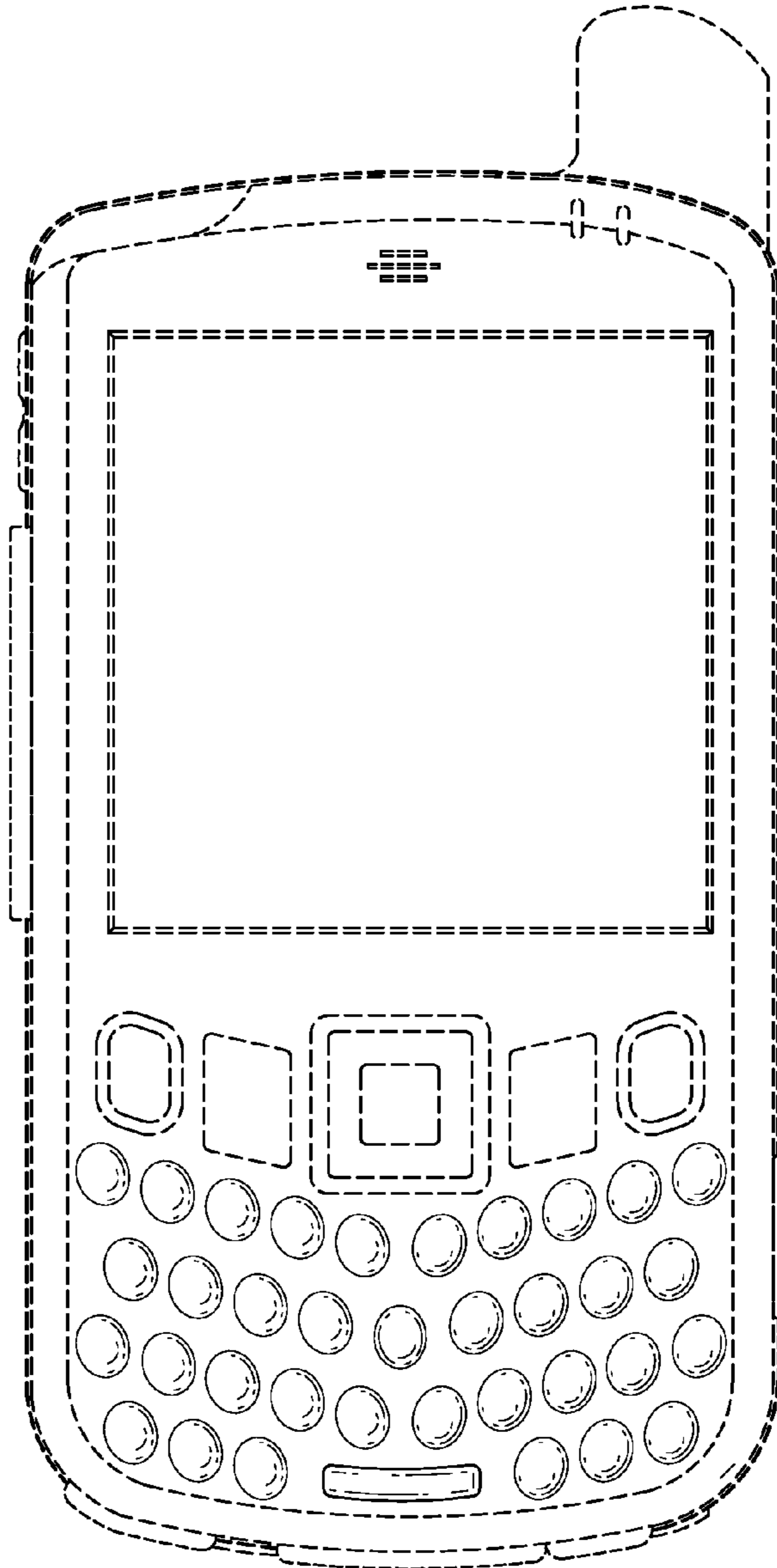

FIG. 4

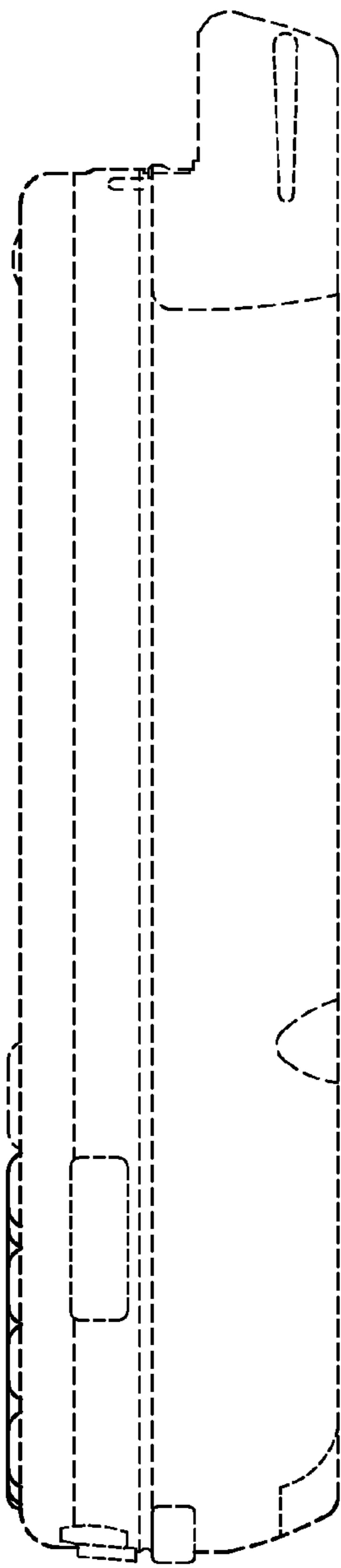

FIG. 5

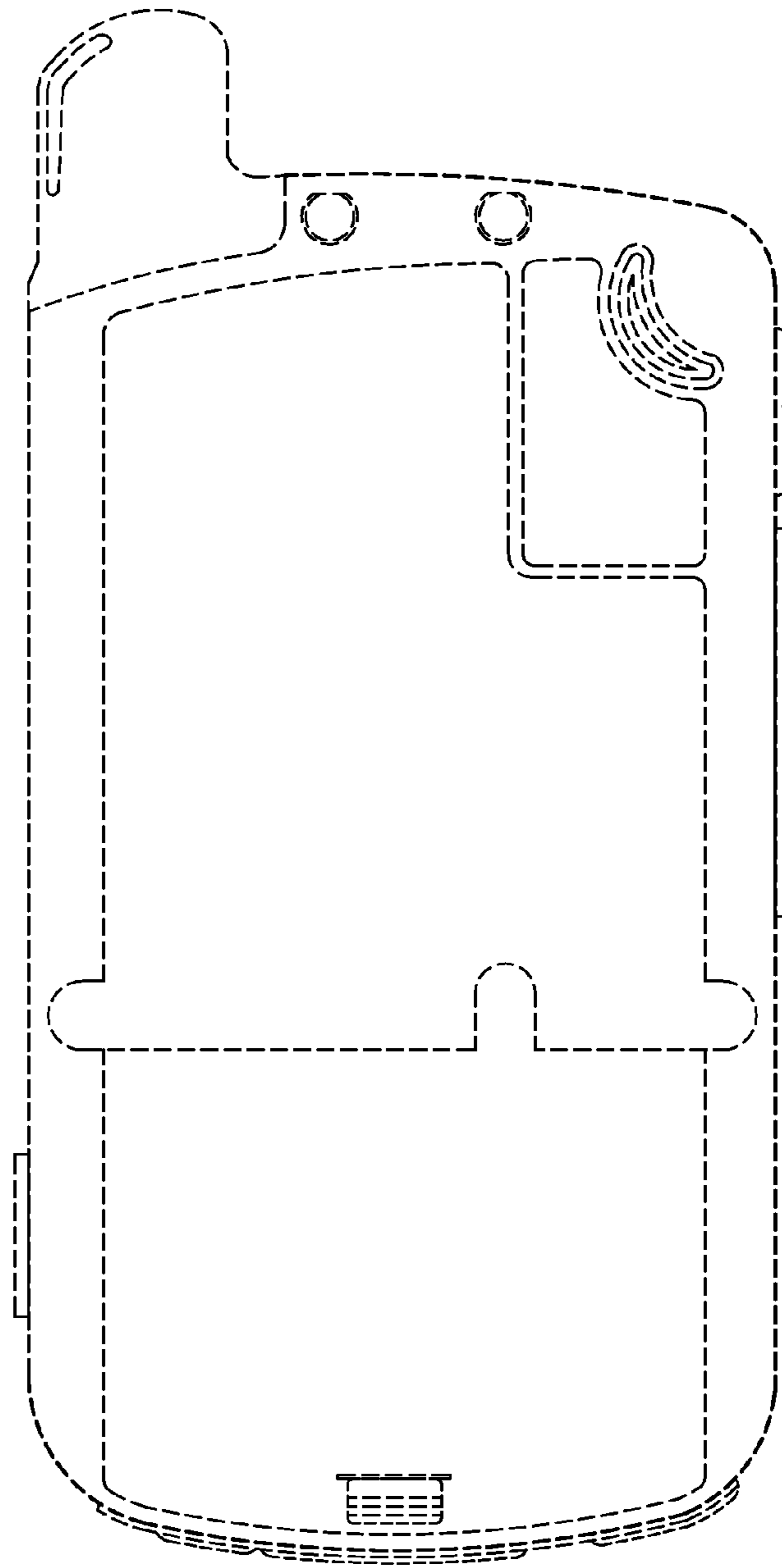

FIG. 6

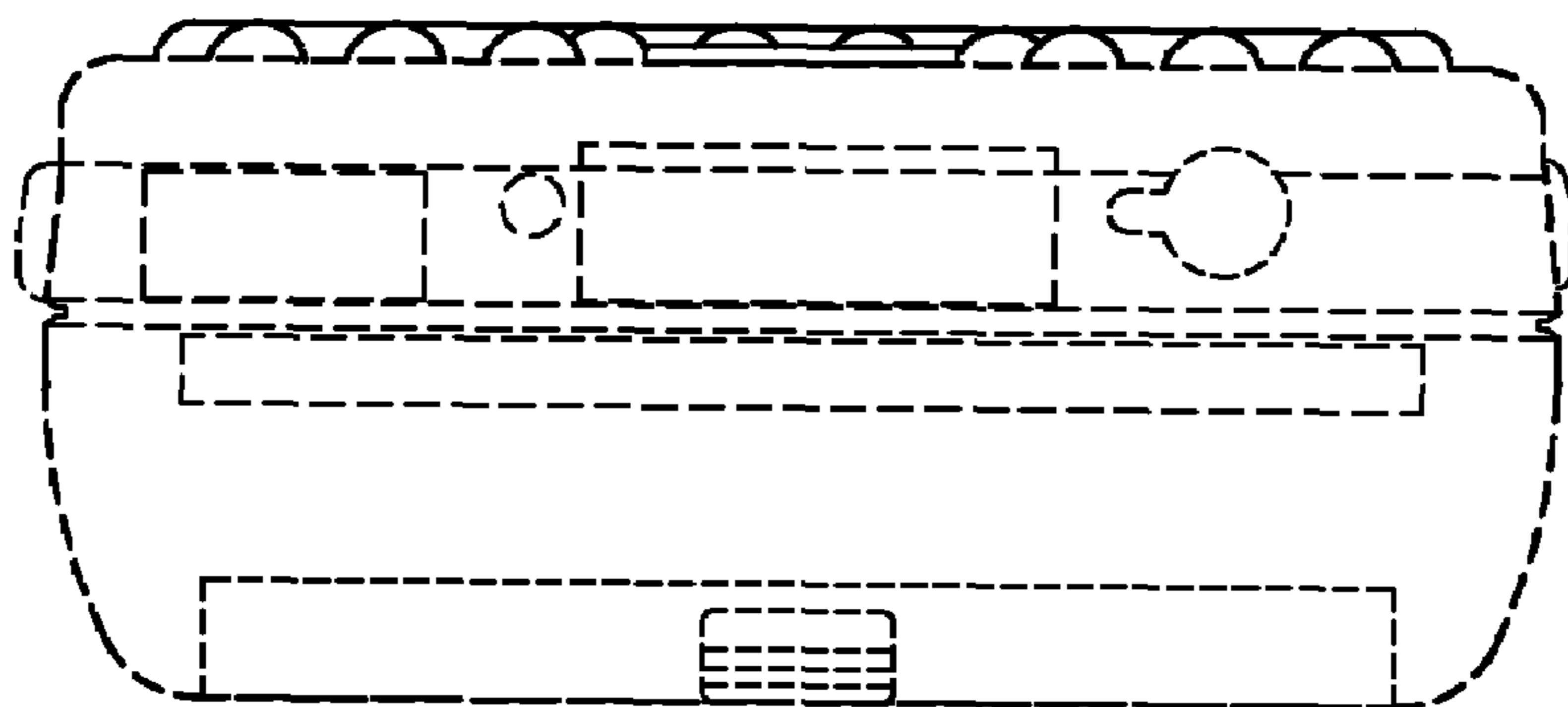

FIG. 7

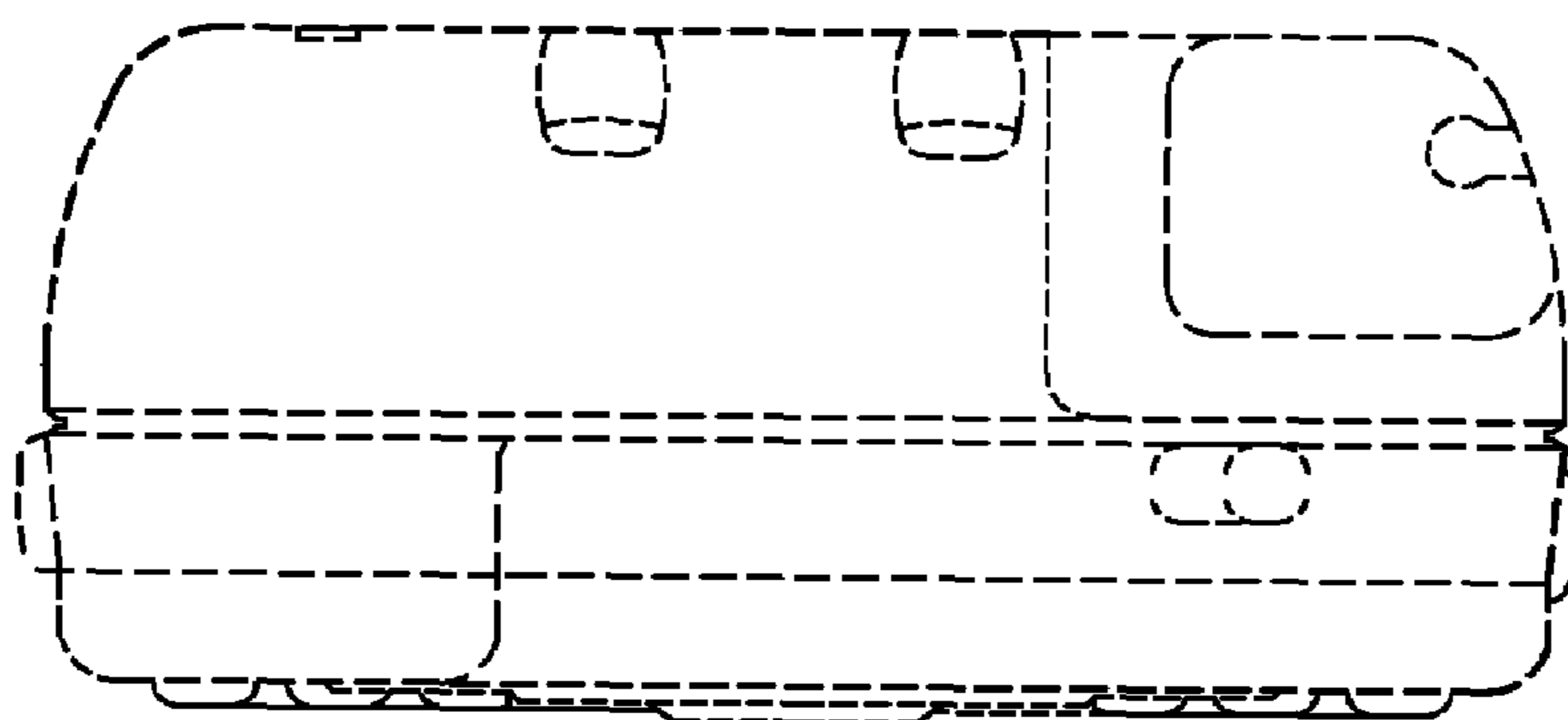

FIG. 8