



US00D595520S

(12) **United States Design Patent**
Su

(10) **Patent No.:** **US D595,520 S**

(45) **Date of Patent:** **** Jul. 7, 2009**

(54) **CHAIR BACKREST**

(76) **Inventor:** **Shu O Su**, No. 3, Keji 2nd Rd., Annan District, Tainan City (TW)

(**) **Term:** **14 Years**

(21) **Appl. No.:** **29/330,116**

(22) **Filed:** **Dec. 29, 2008**

(51) **LOC (9) Cl.** **06-01**

(52) **U.S. Cl.** **D6/502**

(58) **Field of Classification Search** D6/334-336,
D6/366, 369, 371-373, 374, 376, 379, 380,
D6/499, 500-502; 297/183.7, 447.2, 447.3,
297/448.2, 451.3, 451.7, 452.29, 452.36,
297/452.46

See application file for complete search history.

(56) **References Cited**

U.S. PATENT DOCUMENTS

D449,172 S *	10/2001	Van De Riet et al.	D6/366
D449,938 S *	11/2001	Vanderiet et al.	D6/380
D456,164 S *	4/2002	Vanderiet et al.	D6/374
D505,801 S *	6/2005	Cesaroni et al.	D6/379
D512,238 S *	12/2005	Chen	D6/380
D541,067 S *	4/2007	Lin	D6/373

D549,479 S *	8/2007	Su	D6/373
D561,485 S *	2/2008	Hock	D6/379
D574,646 S *	8/2008	Su	D6/502
D586,577 S *	2/2009	Koh	D6/376

* cited by examiner

Primary Examiner—Mimosa De

(74) *Attorney, Agent, or Firm*—Pro-Techtor International Services; Ralph Willgohs

(57) **CLAIM**

The ornamental design for a chair backrest, as shown and described.

DESCRIPTION

FIG. 1 is a perspective view of a chair backrest showing my new design;

FIG. 2 is a front view of the design;

FIG. 3 is a rear view of the design;

FIG. 4 is a left side view of the design;

FIG. 5 is a right side view of the design;

FIG. 6 is a top view of the design; and,

FIG. 7 is a bottom view of the design.

1 Claim, 5 Drawing Sheets

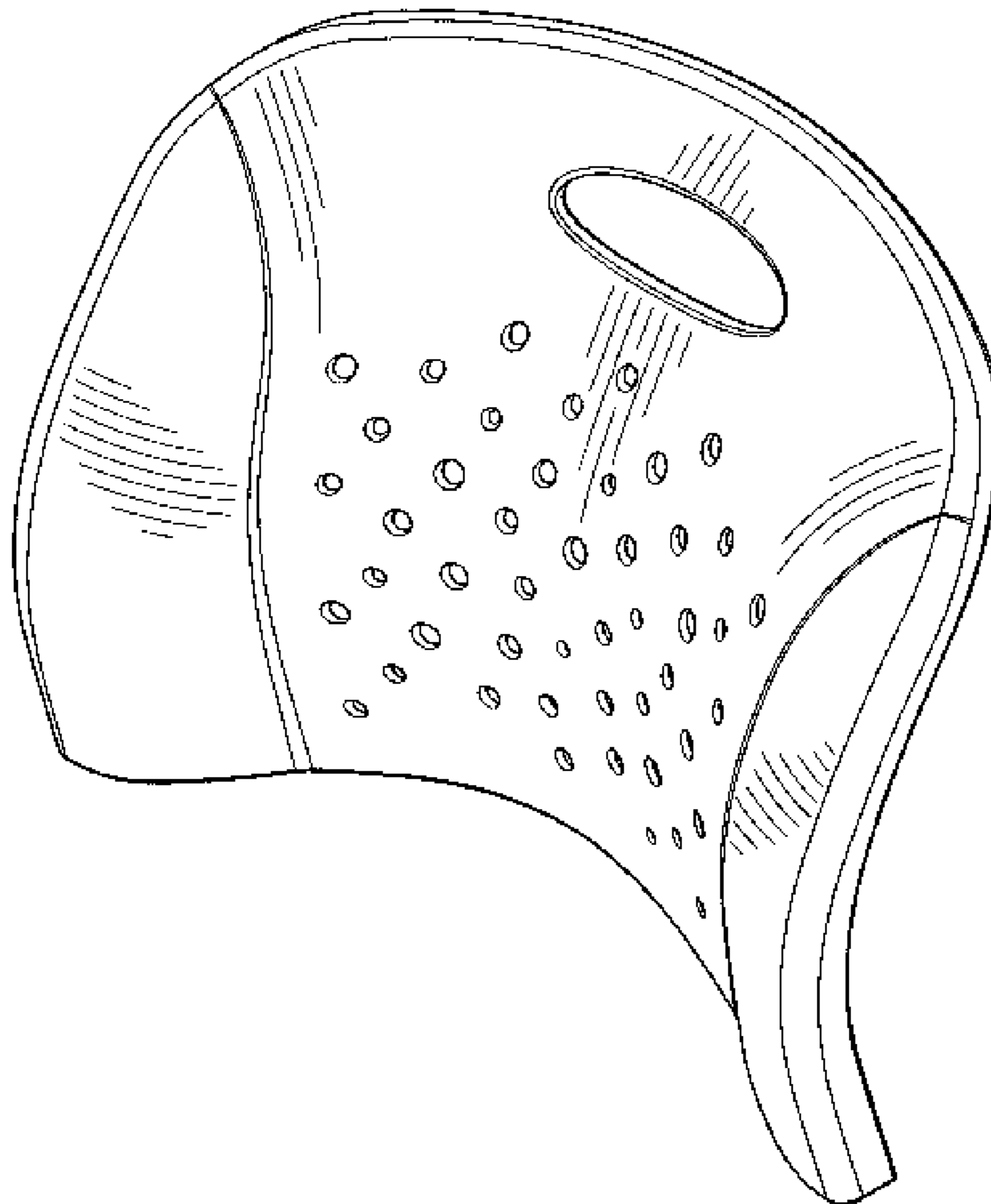

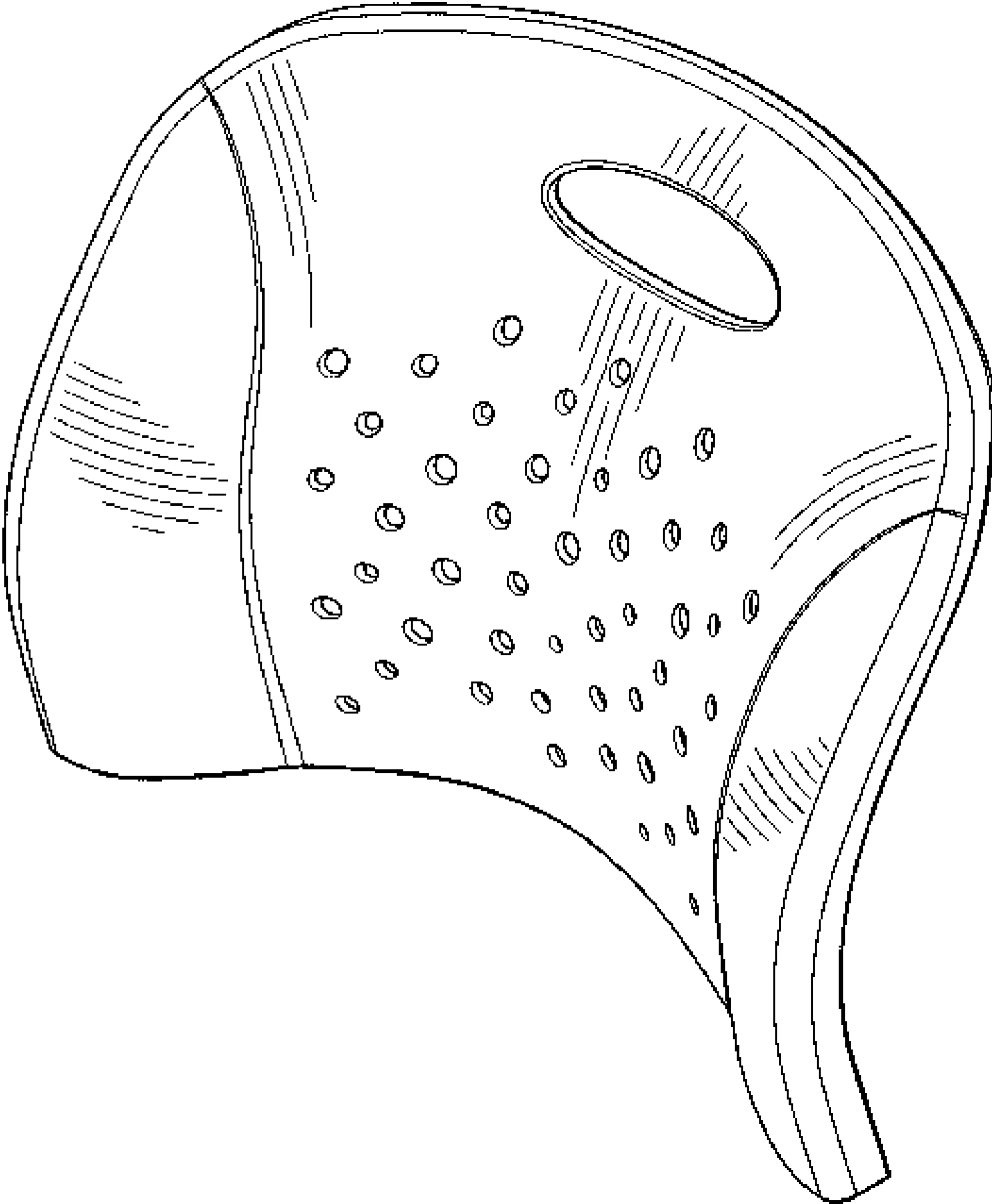

FIG. 1

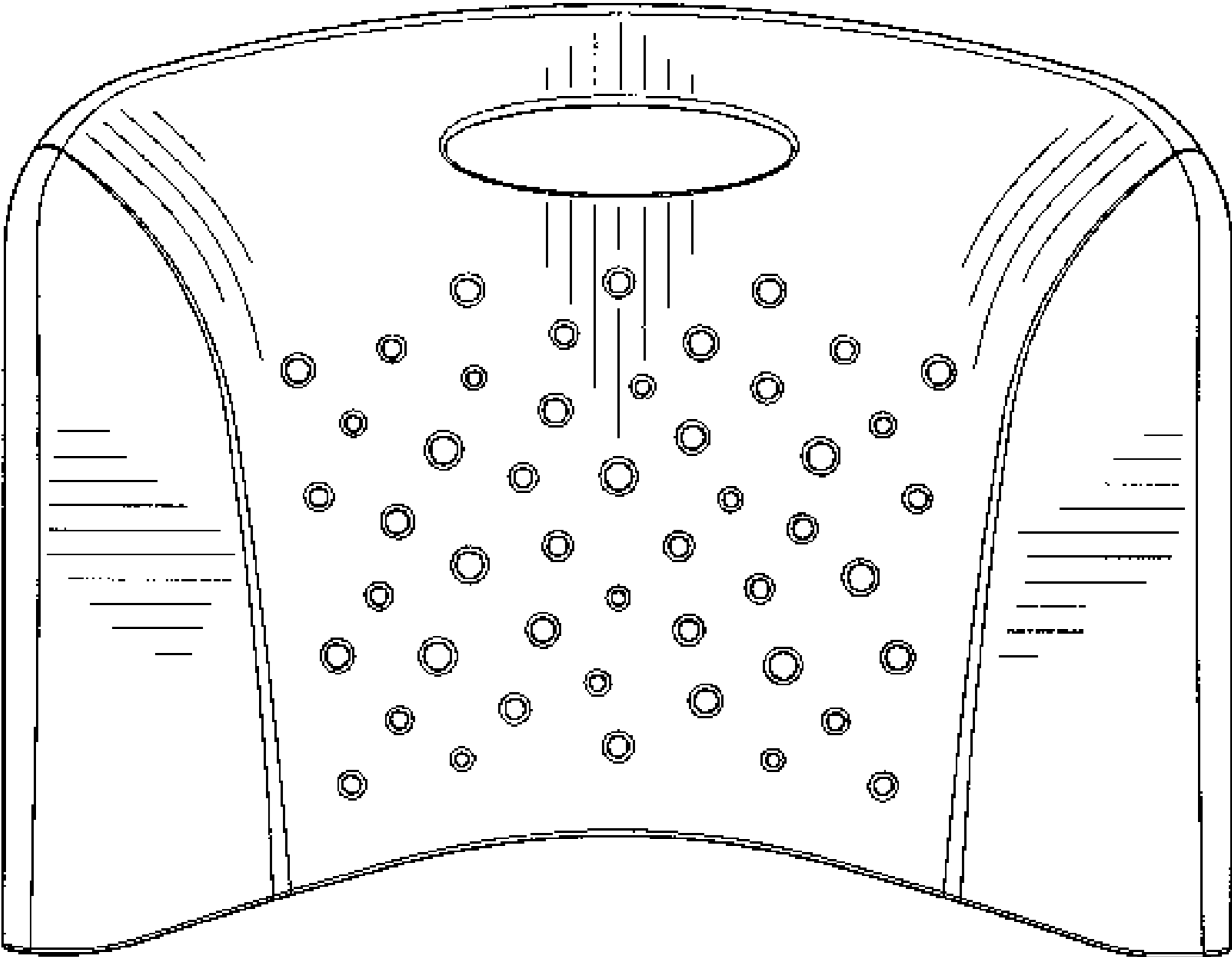

FIG. 2

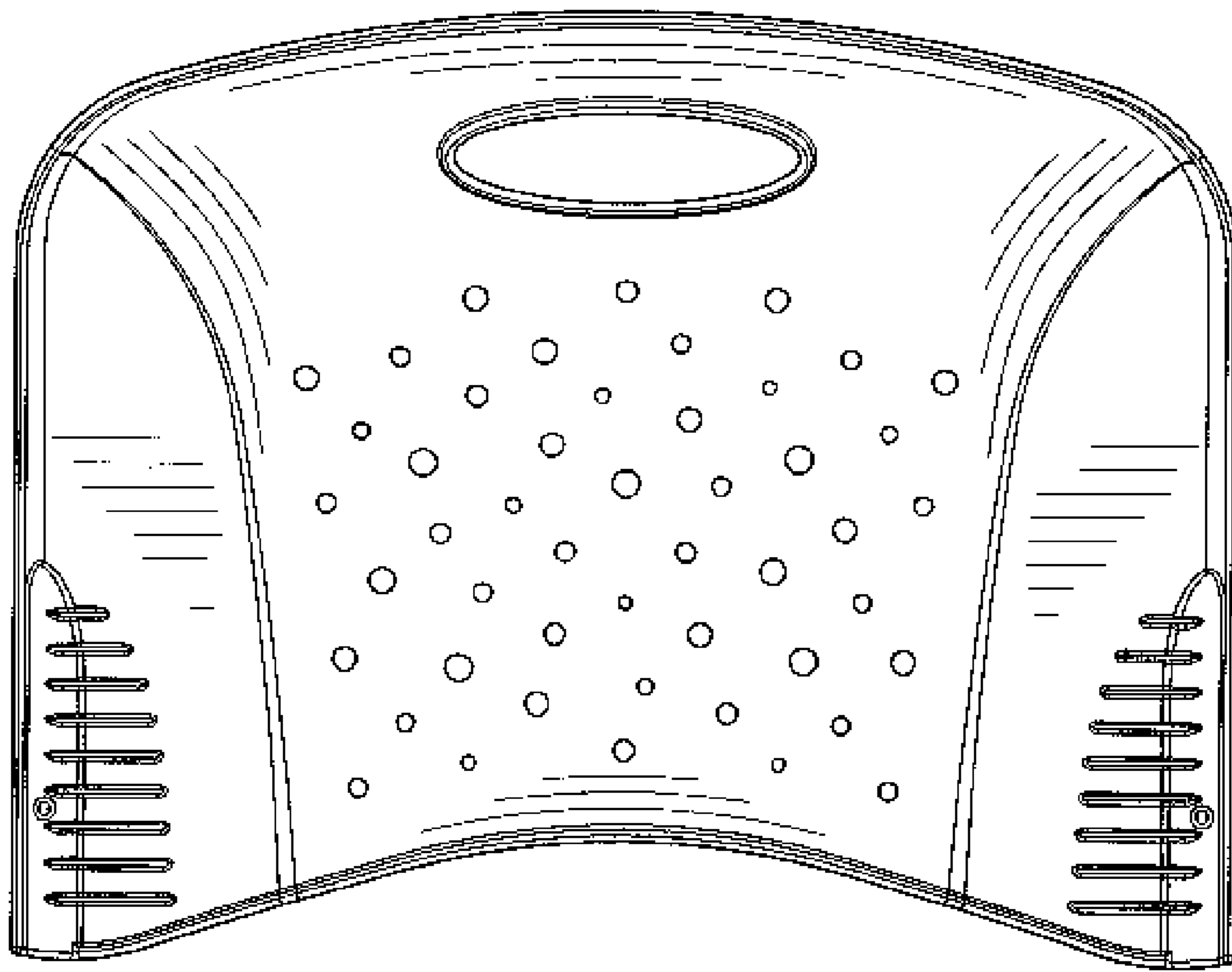

FIG. 3

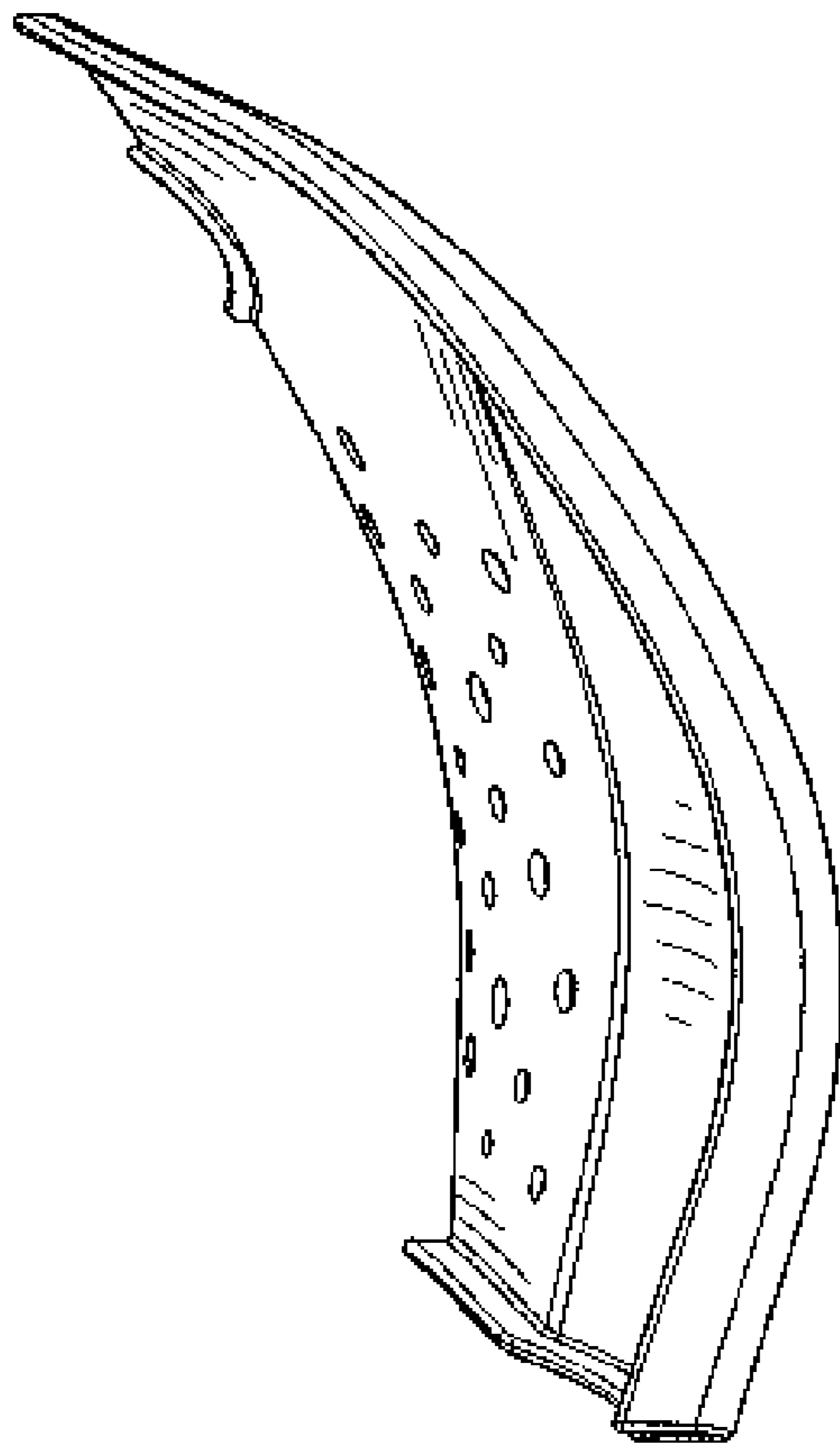

FIG. 4

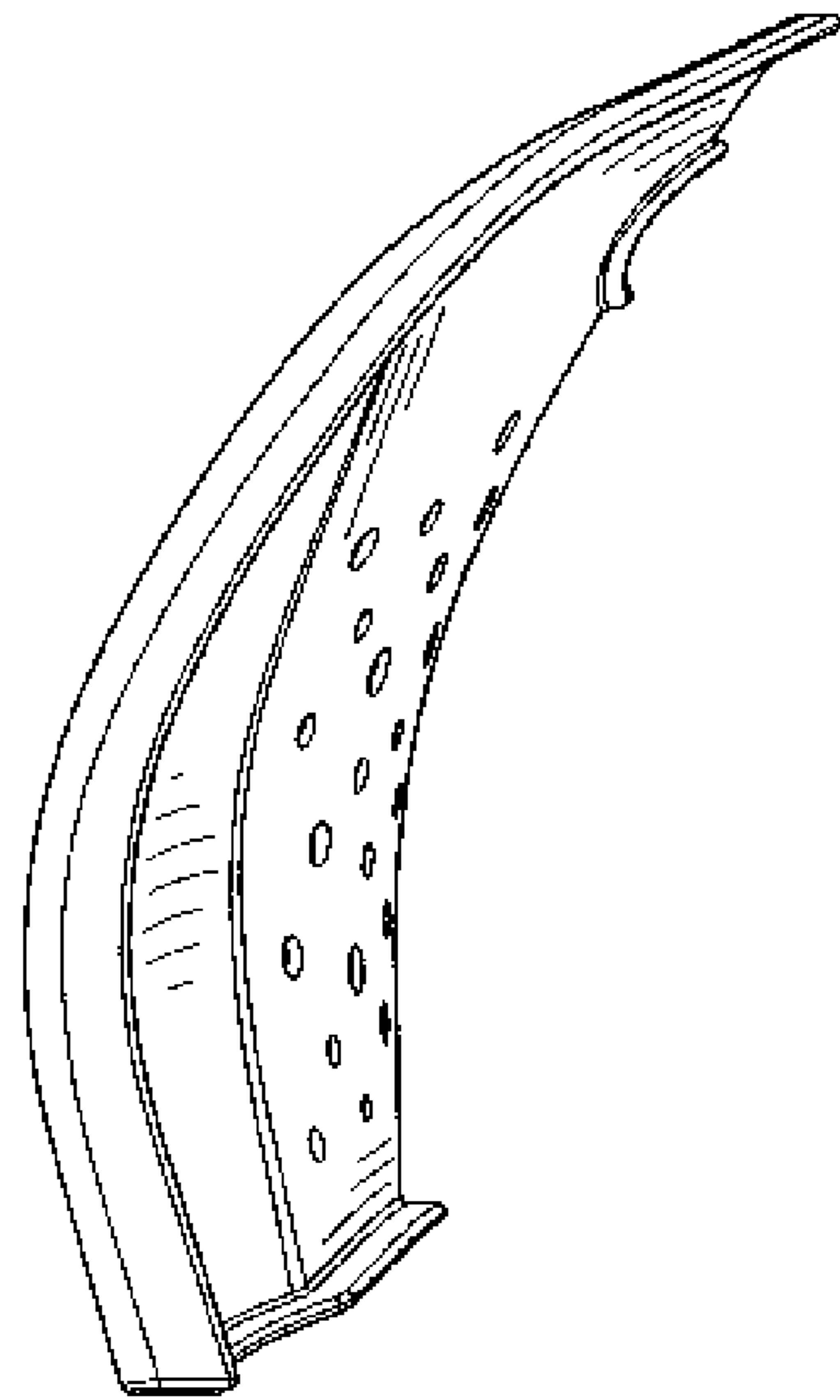

FIG. 5

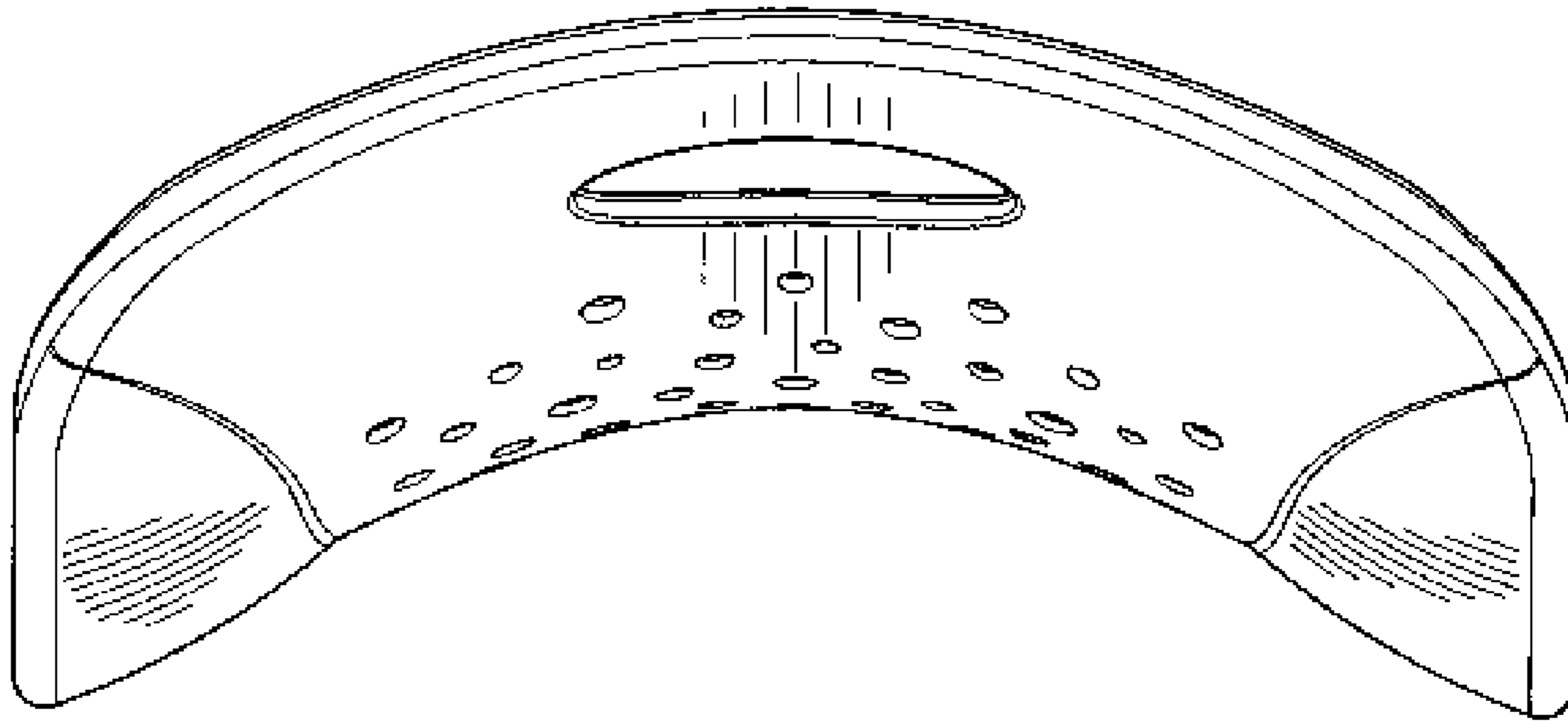

FIG. 6

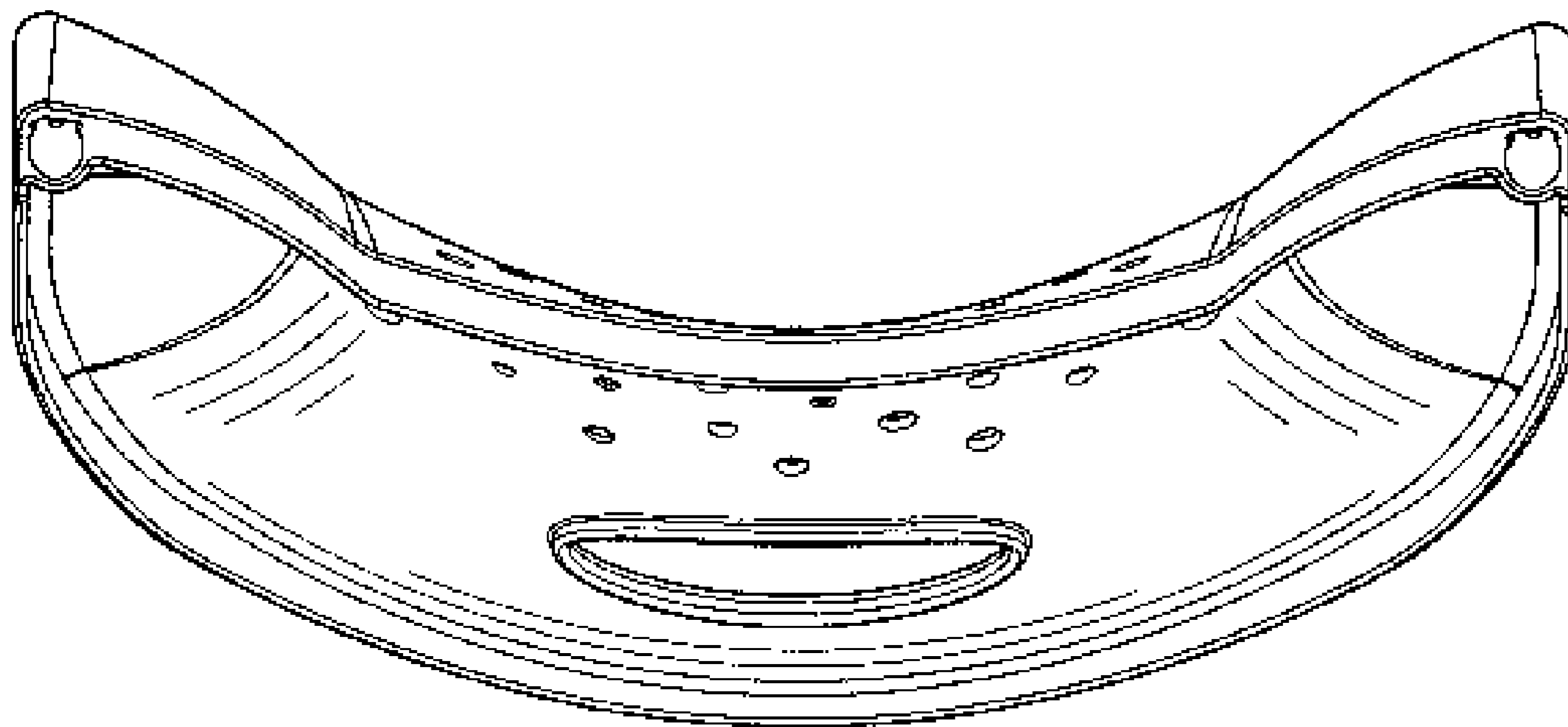

FIG. 7