



US00D595461S

(12) **United States Design Patent**
Massip et al.

(10) **Patent No.:** **US D595,461 S**
(45) **Date of Patent:** **** Jun. 30, 2009**

(54) **STEAM BRUSH**

(75) Inventors: **Victor Massip**, Nantes (FR); **Laurent Lebot**, Nantes (FR)

(73) Assignee: **Rowenta Werke GmbH**, Offenbach am Main (DE)

(**) Term: **14 Years**

(21) Appl. No.: **29/327,998**

(22) Filed: **Nov. 17, 2008**

Related U.S. Application Data

(62) Division of application No. 29/280,540, filed on May 31, 2007.

(30) **Foreign Application Priority Data**

Dec. 14, 2006 (FR) 06 5725

(51) **LOC (9) Cl.** **15-05**

(52) **U.S. Cl.** **D32/17**

(58) **Field of Classification Search** D32/9,
D32/68-73, 17-18, 21, 23-24, 31-33; 68/5 R,
68/222, 5 A; 38/85, 82, 77.8, 81, 94, 77.83,
38/79, 96, 77.5-77.9, 3, 69, 77.3; 392/403-406,
392/324, 333, 342, 379; 219/259, 242, 254,
219/246; 8/149.3; 15/344, 329, 320-322,
15/415.1-422.1, 327.1-327.2, 327.5-327.7,
15/414, 398, 400

See application file for complete search history.

(56) **References Cited**

U.S. PATENT DOCUMENTS

D200,092 S 1/1965 Polatchek
D205,994 S 10/1966 Ota
D222,502 S 10/1971 Madl et al.
D229,664 S 12/1973 Stutzer

D266,962 S 11/1982 Hachtmann et al.
D319,121 S * 8/1991 Muller D32/17
5,609,047 A * 3/1997 Hellman et al. 68/222
D416,361 S 11/1999 Haghdan et al.
D421,670 S 3/2000 Schupp
D436,424 S 1/2001 Buzzi
D465,309 S 11/2002 Foersterling
D473,987 S 4/2003 Foersterling
6,886,373 B2 * 5/2005 Carrubba et al. 68/222
D511,232 S * 11/2005 Barquin Santillan et al. . D32/35
D540,498 S 4/2007 Tobias
D541,494 S * 4/2007 Tsen D32/17
D541,500 S * 4/2007 Leung D32/35
D561,958 S 2/2008 Hahn
D576,363 S * 9/2008 Reiner D32/17
2004/0144140 A1 * 7/2004 Lee 68/222

* cited by examiner

Primary Examiner—Ruth McInroy

(74) *Attorney, Agent, or Firm*—Oblon, Spivak, McClelland, Maier & Neustadt, P.C.

(57) **CLAIM**

We claim the ornamental design for a steam brush, as shown and described.

DESCRIPTION

FIG. 1 is a front, top, left perspective view of a steambrush;
FIG. 2 is a rear, top, left view thereof;
FIG. 3 is a rear, bottom, left view thereof;
FIG. 4 is a left view thereof;
FIG. 5 is a right view thereof;
FIG. 6 is a front view thereof;
FIG. 7 is a rear view thereof;
FIG. 8 is a top view thereof; and,
FIG. 9 is a bottom view thereof.

1 Claim, 9 Drawing Sheets

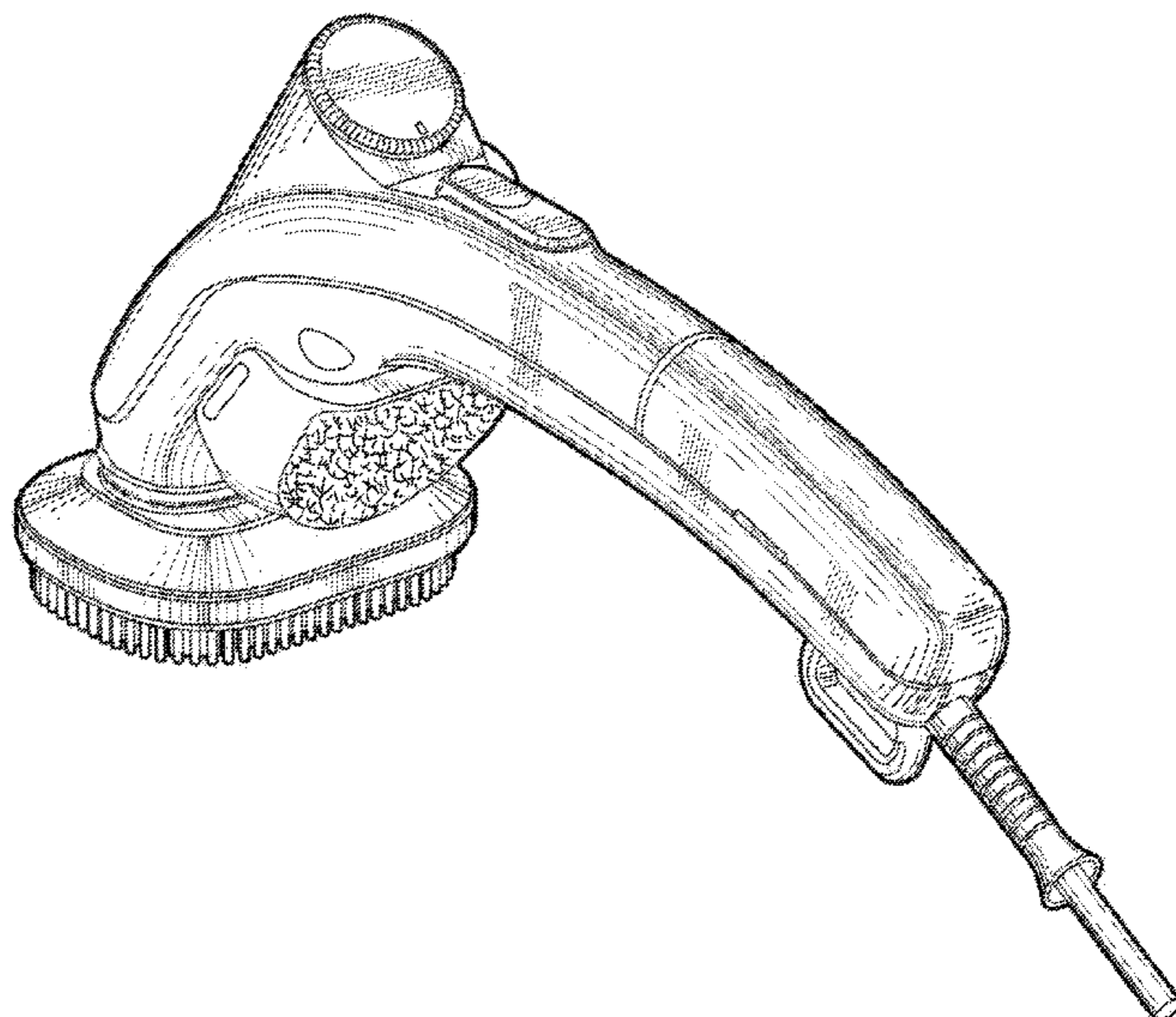
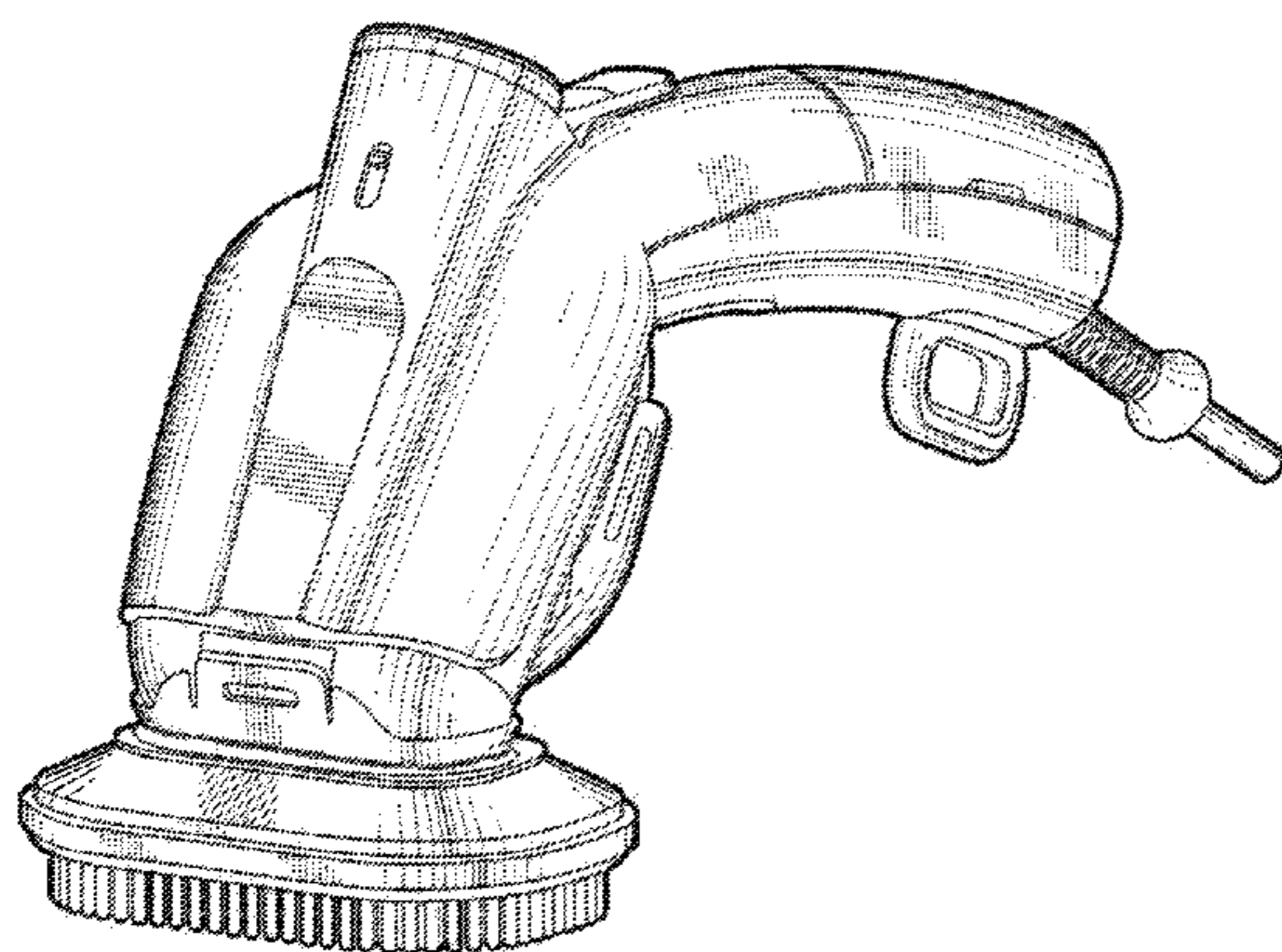

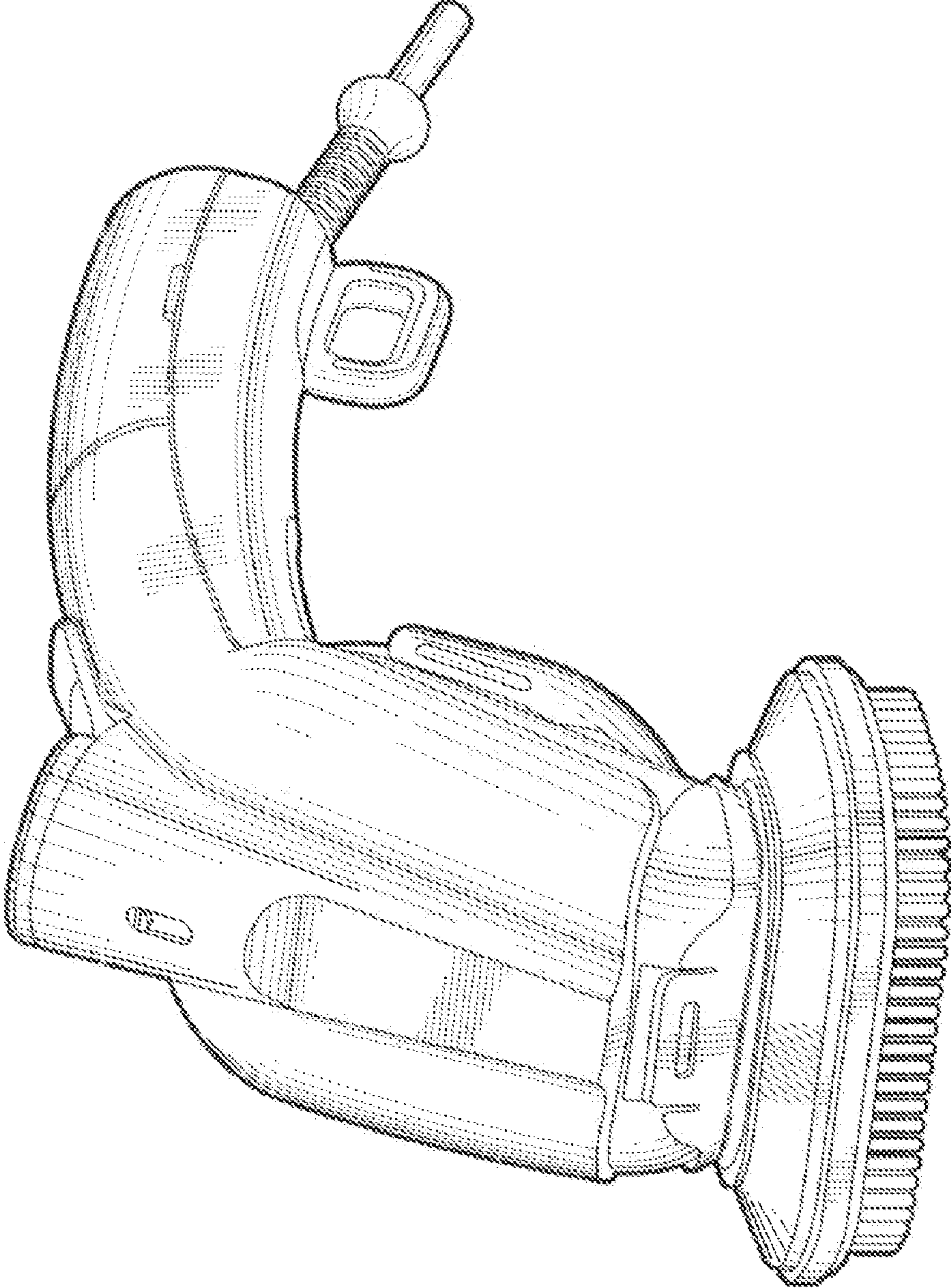

Fig. 1

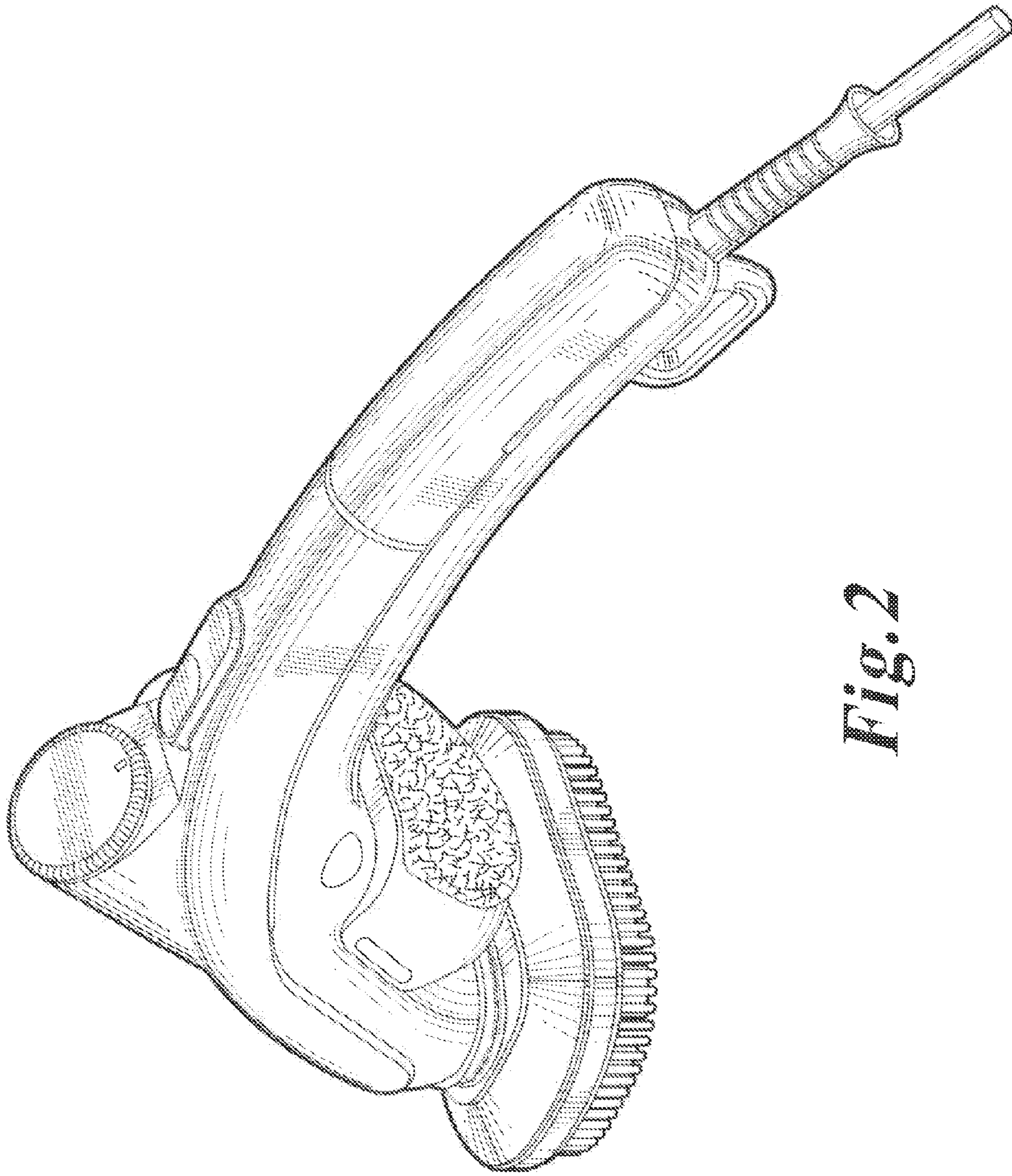

Fig. 2

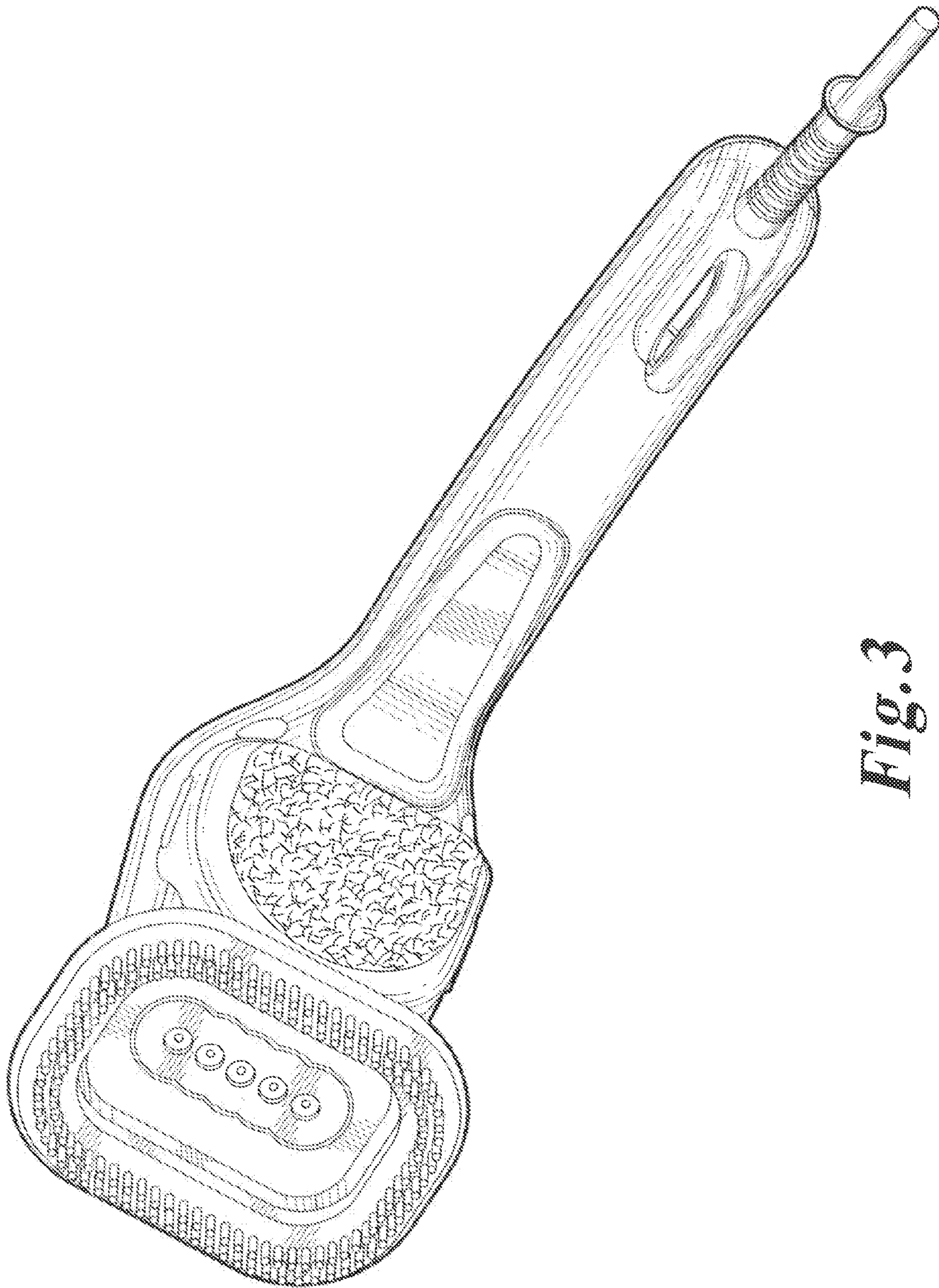

Fig. 3

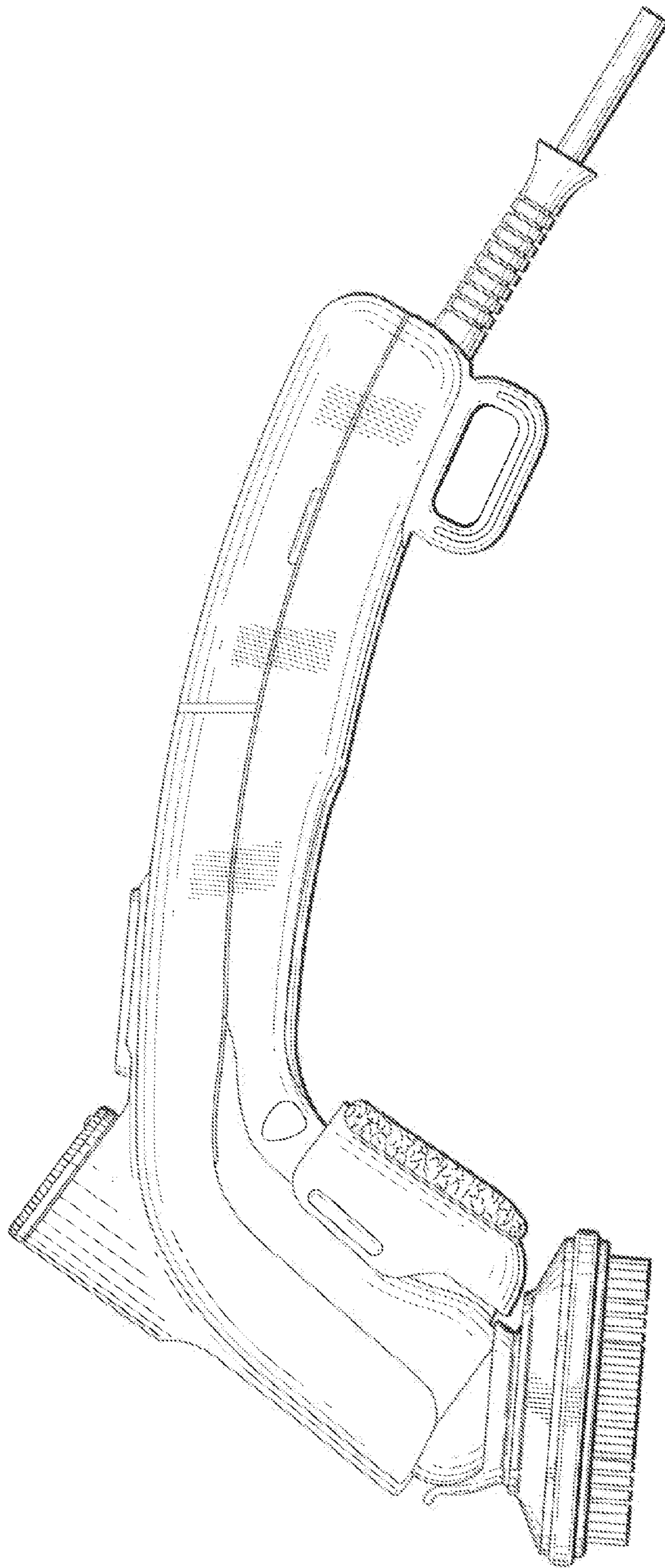

Fig. 4

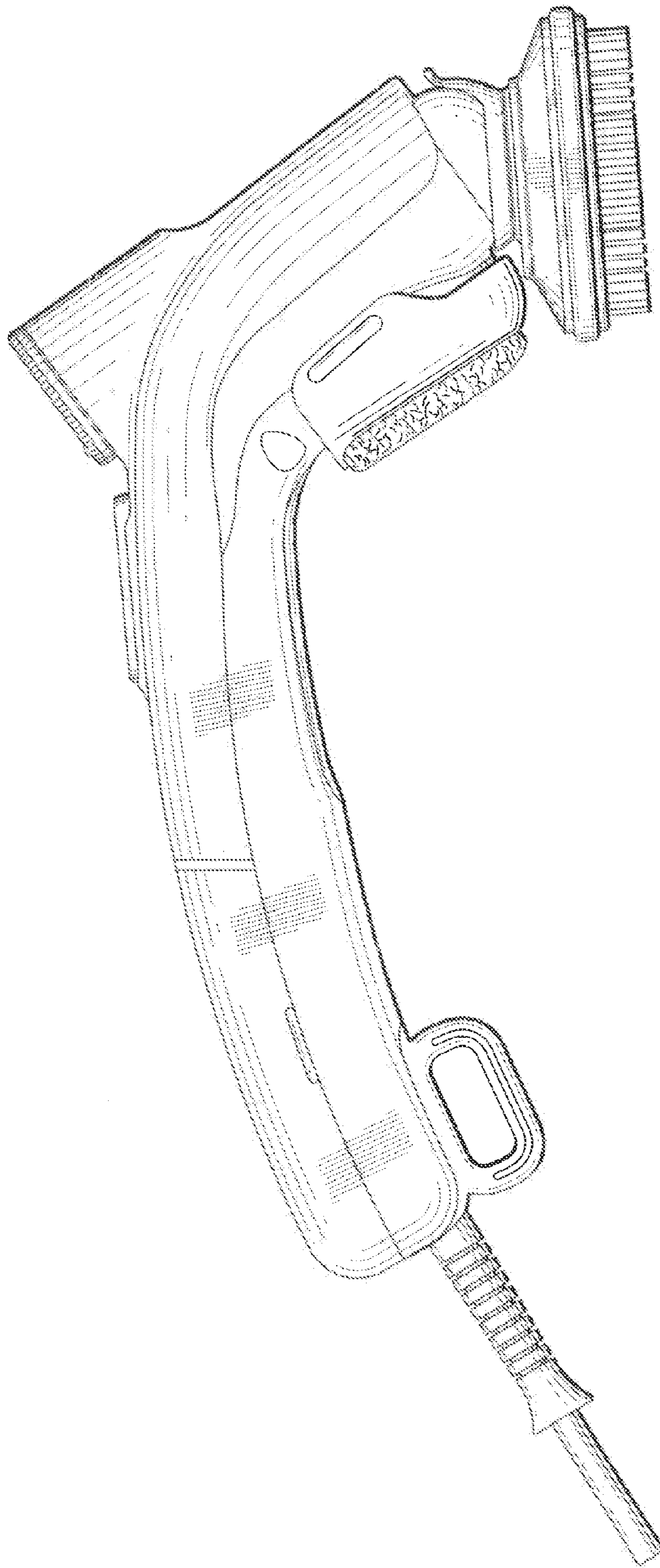

Fig. 5

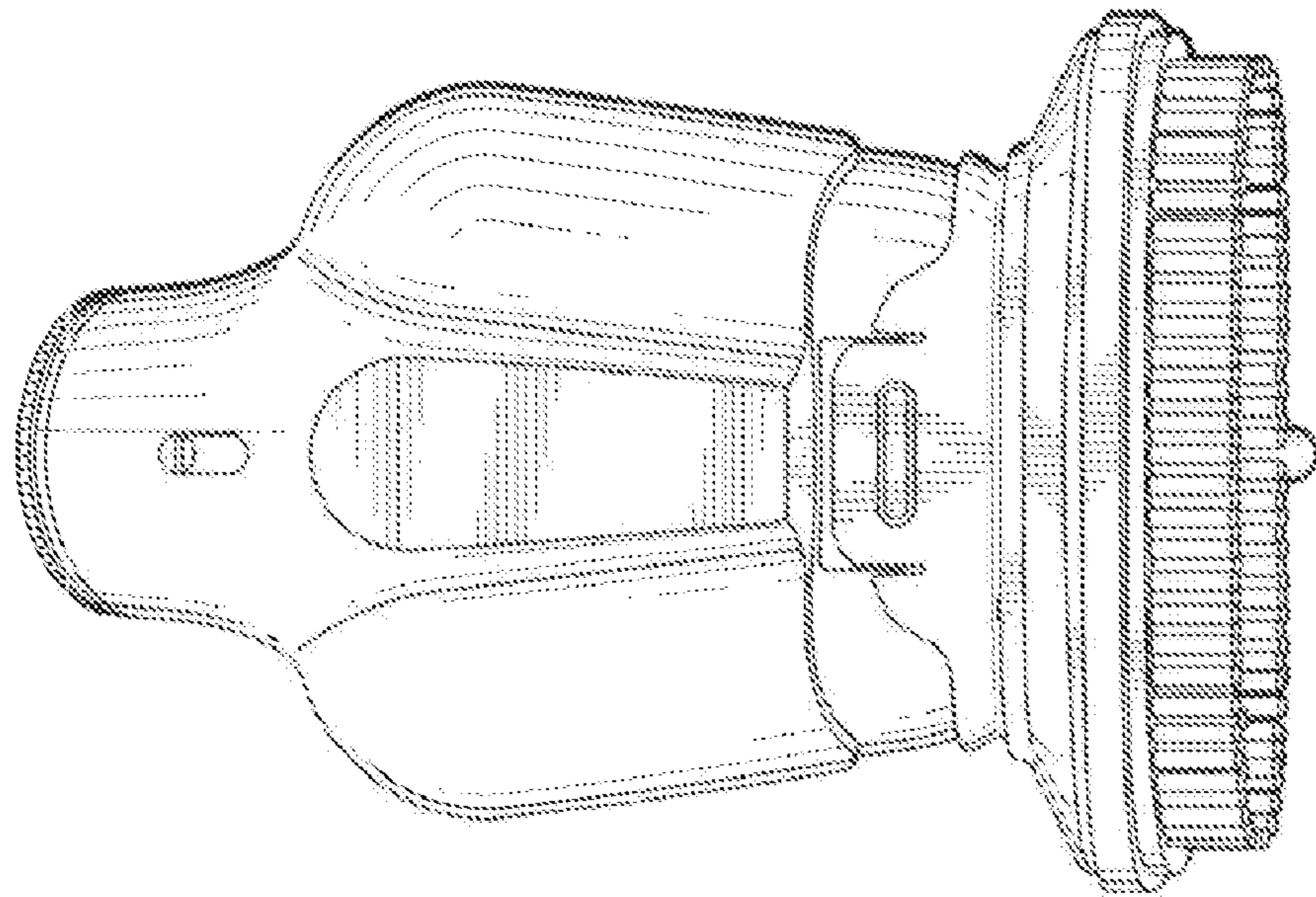

Fig. 6

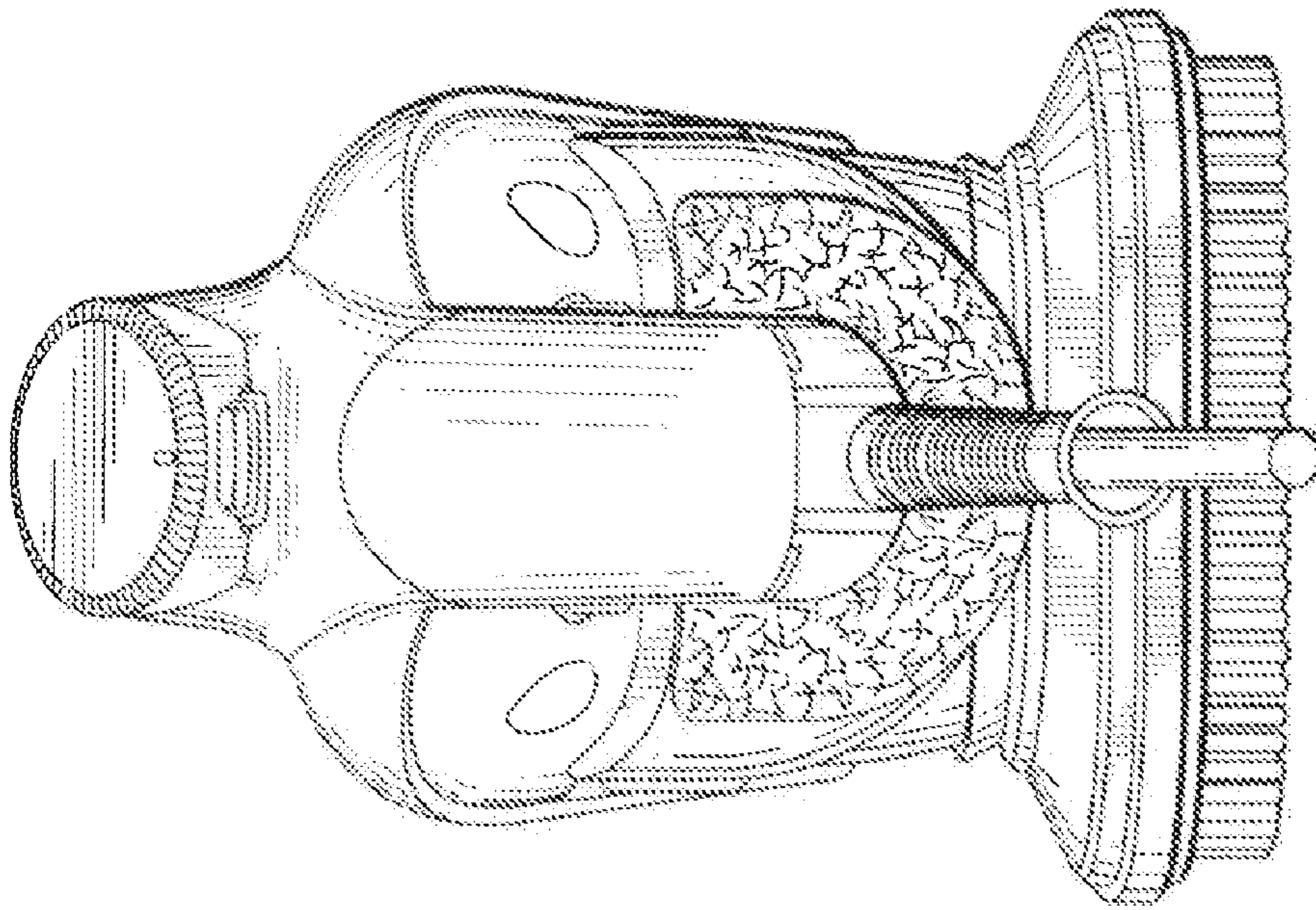

Fig. 7

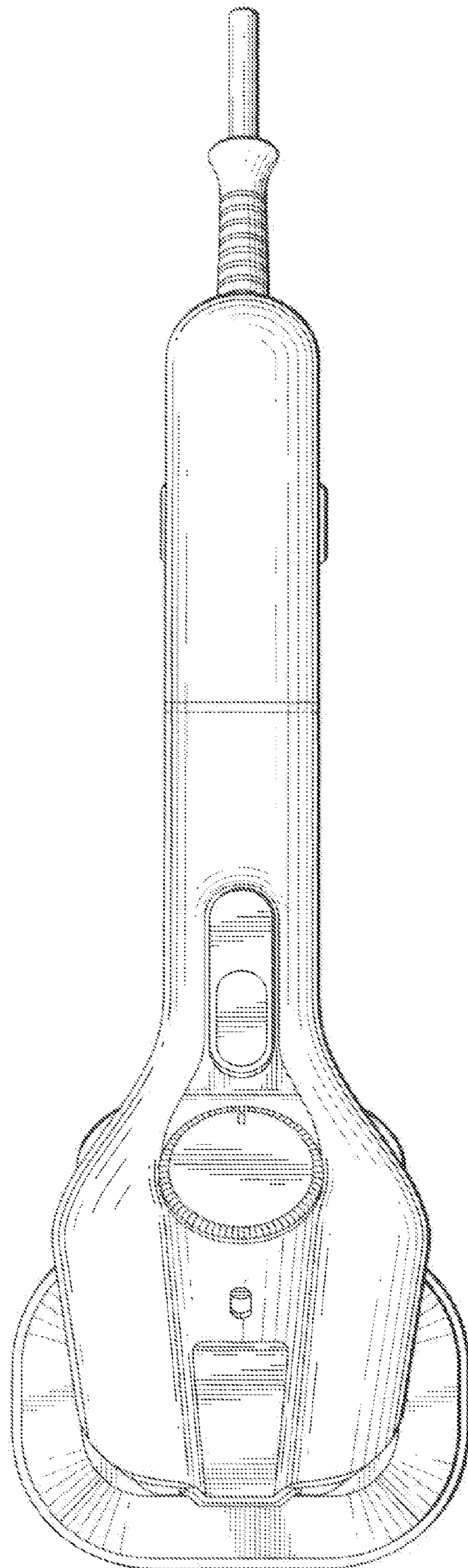

Fig. 8

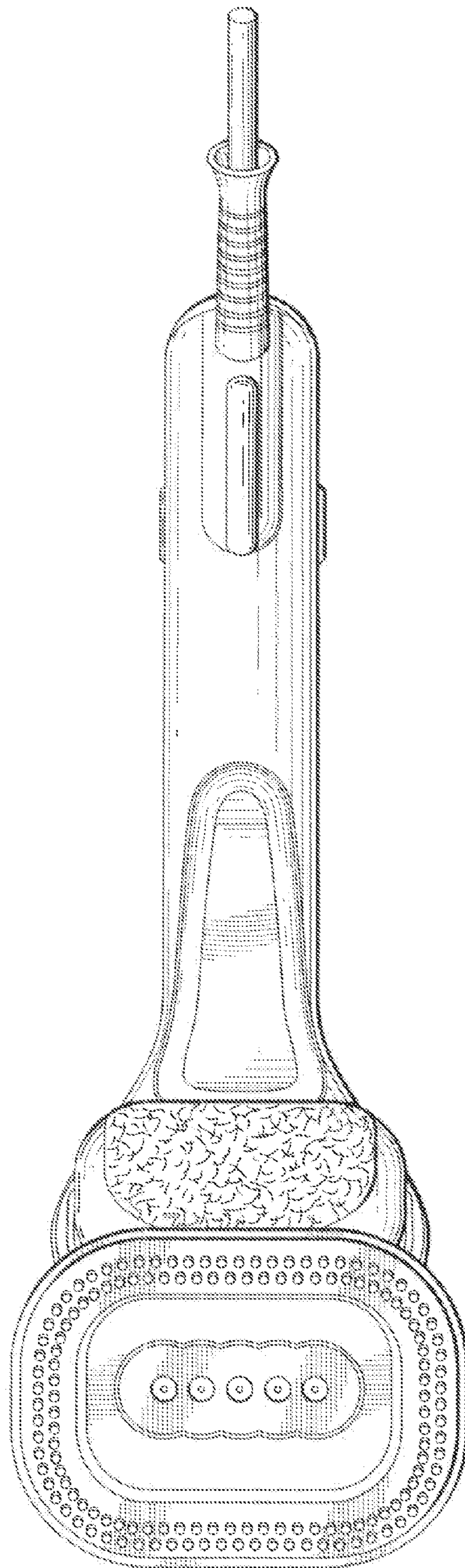

Fig. 9