



US00D595418S

(12) **United States Design Patent**
Archer

(10) **Patent No.:** **US D595,418 S**
(45) **Date of Patent:** **** Jun. 30, 2009**

(54) **HOT WATER BOTTLE**

(76) Inventor: **Jillian Nola Archer**, 3 Smedley La.,
Pomona, Queensland (AU) 4568

(**) Term: **14 Years**

(21) Appl. No.: **29/309,866**

(22) Filed: **Oct. 29, 2008**

(30) **Foreign Application Priority Data**

May 8, 2008 (AU) 12229/2008

(51) **LOC (9) Cl.** **28-03**

(52) **U.S. Cl.** **D24/206**

(58) **Field of Classification Search** D24/200,
D24/206, 207, 208; 601/16, 39, 96, 108,
601/112, 110, 111, 114; D21/662
See application file for complete search history.

(56) **References Cited**

U.S. PATENT DOCUMENTS

- 5,267,931 A * 12/1993 Faetini 602/18
- 5,295,949 A * 3/1994 Hathaway 607/109
- 5,375,278 A * 12/1994 VanWinkle et al. D24/206
- D380,050 S * 6/1997 Cappelli et al. D24/206
- D438,577 S * 3/2001 Phillips D21/662

D556,333 S * 11/2007 Hoffman et al. D24/206

FOREIGN PATENT DOCUMENTS

AU 2006101000 A4 12/2006

* cited by examiner

Primary Examiner—Cathron C Brooks

Assistant Examiner—Melanie Levy

(74) *Attorney, Agent, or Firm*—Nixon & Vanderhye P.C.

(57) **CLAIM**

The ornamental design for a hot water bottle, as shown and described.

DESCRIPTION

FIG. 1 is a perspective view of the hot water bottle in accordance with the present invention;

FIG. 2 is a front view of the invention shown in FIG. 1;

FIG. 3 is an rear view of the invention shown in FIG. 1;

FIG. 4 is a top plan view of the invention shown in FIG. 1;

FIG. 5 is a bottom plan view of the invention shown in FIG. 1; and,

FIG. 6 is a left side view of the invention shown in FIG. 1, and the right side view of the invention is a mirror image of FIG. 6.

1 Claim, 2 Drawing Sheets

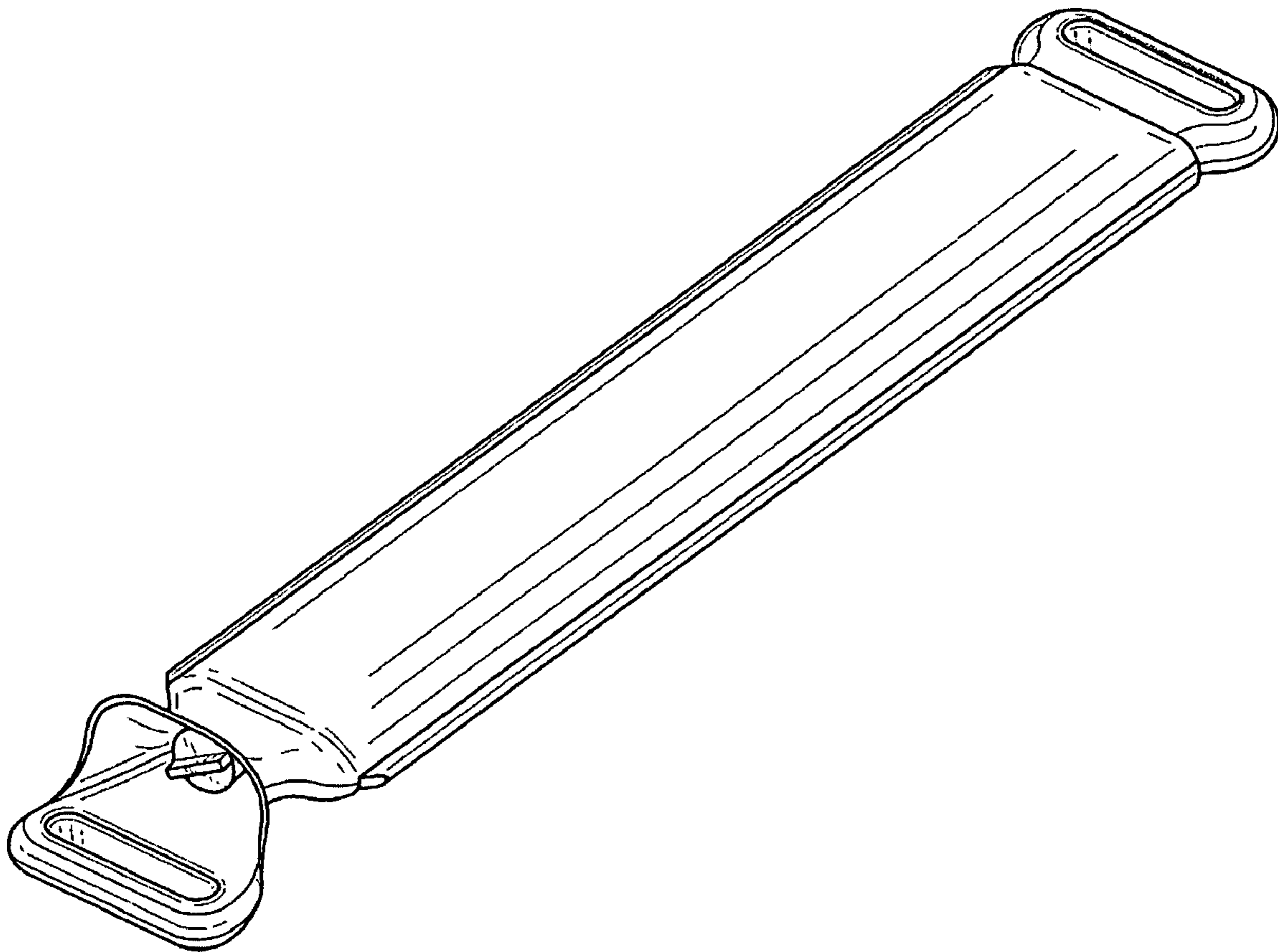

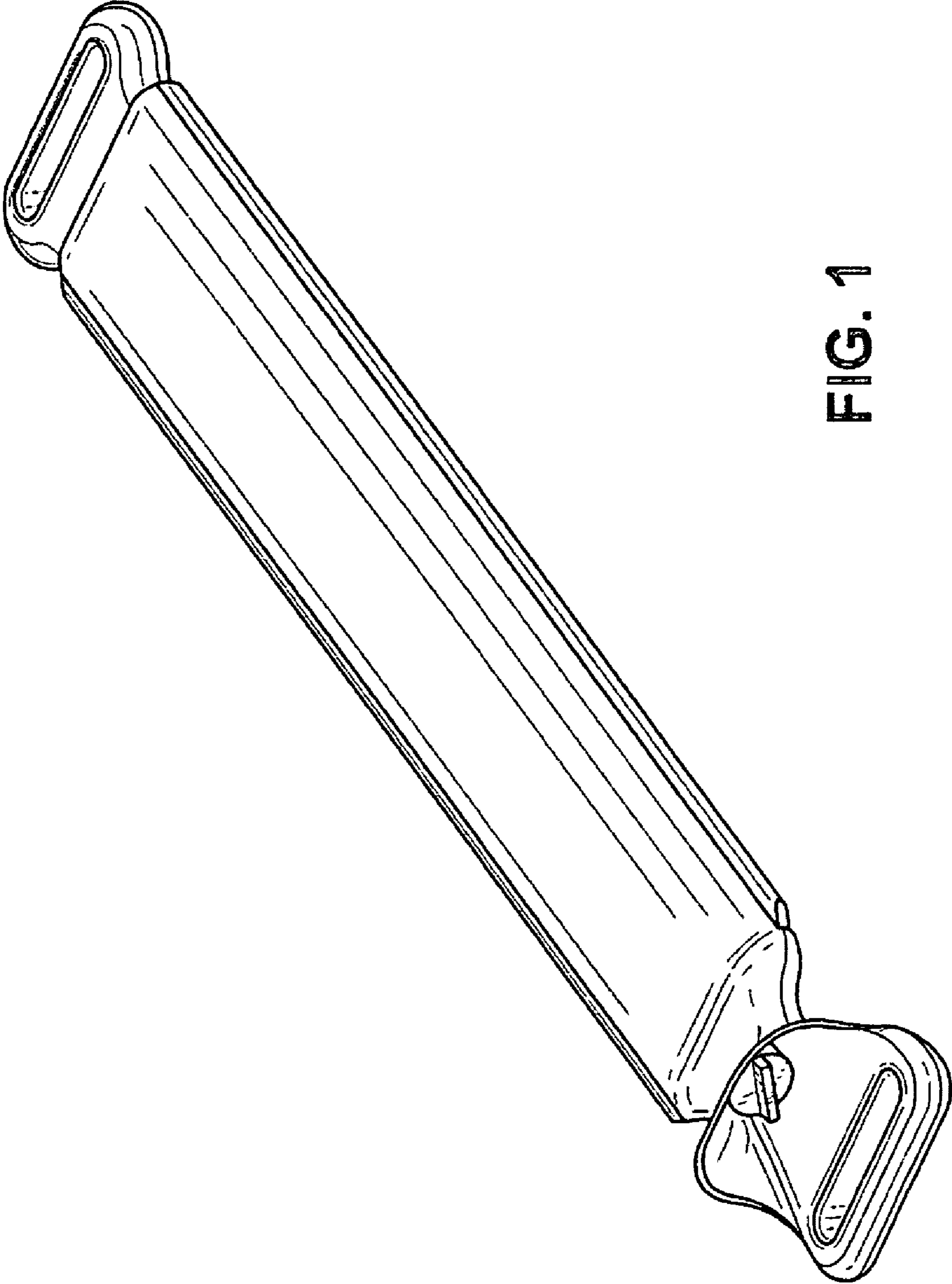

FIG. 1

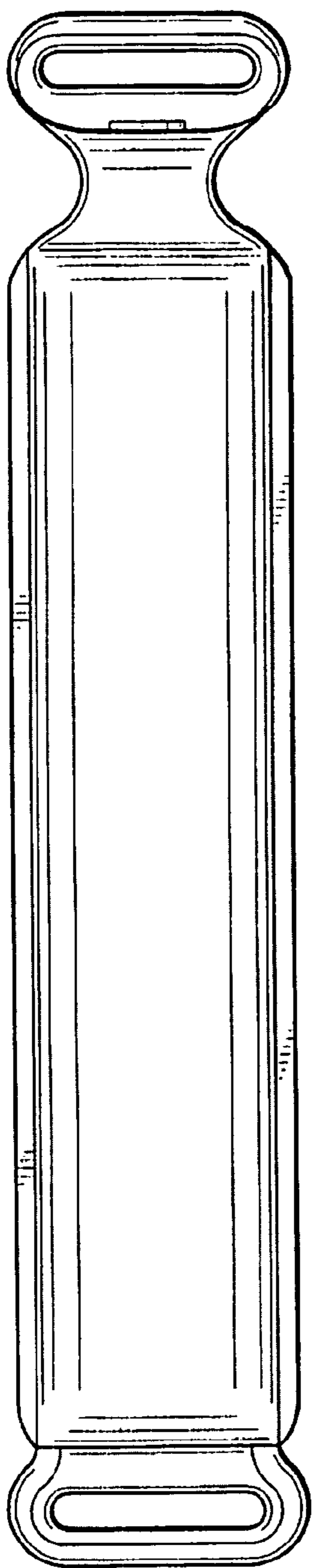

FIG. 4

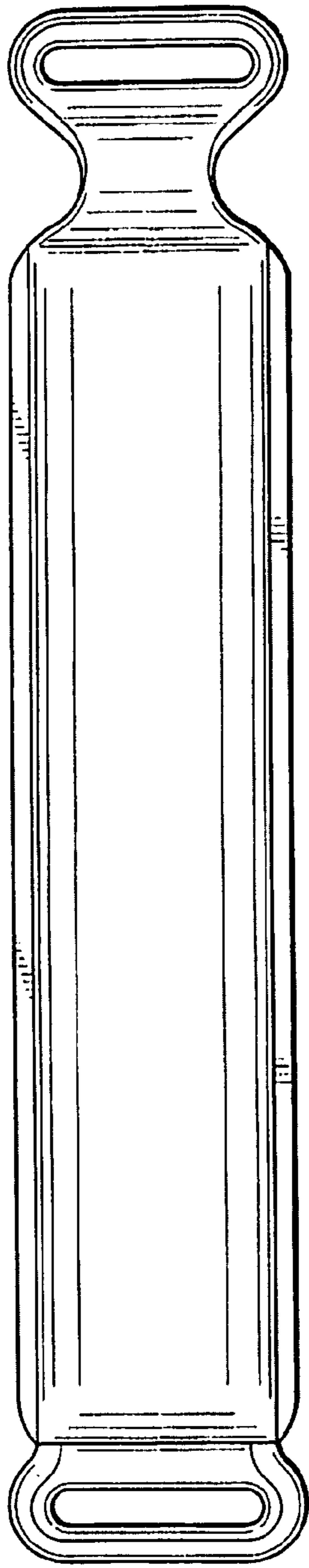

FIG. 5

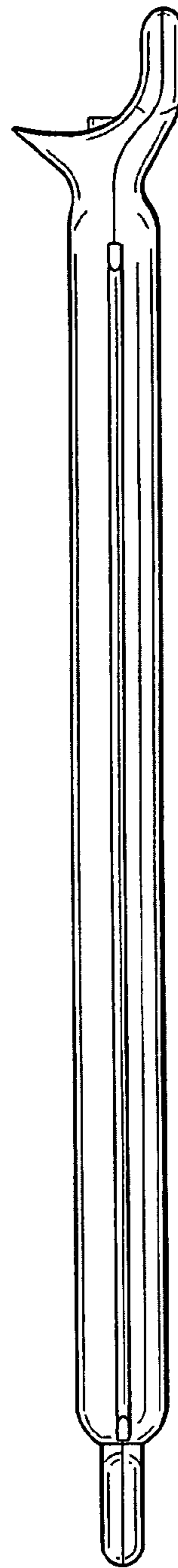

FIG. 6

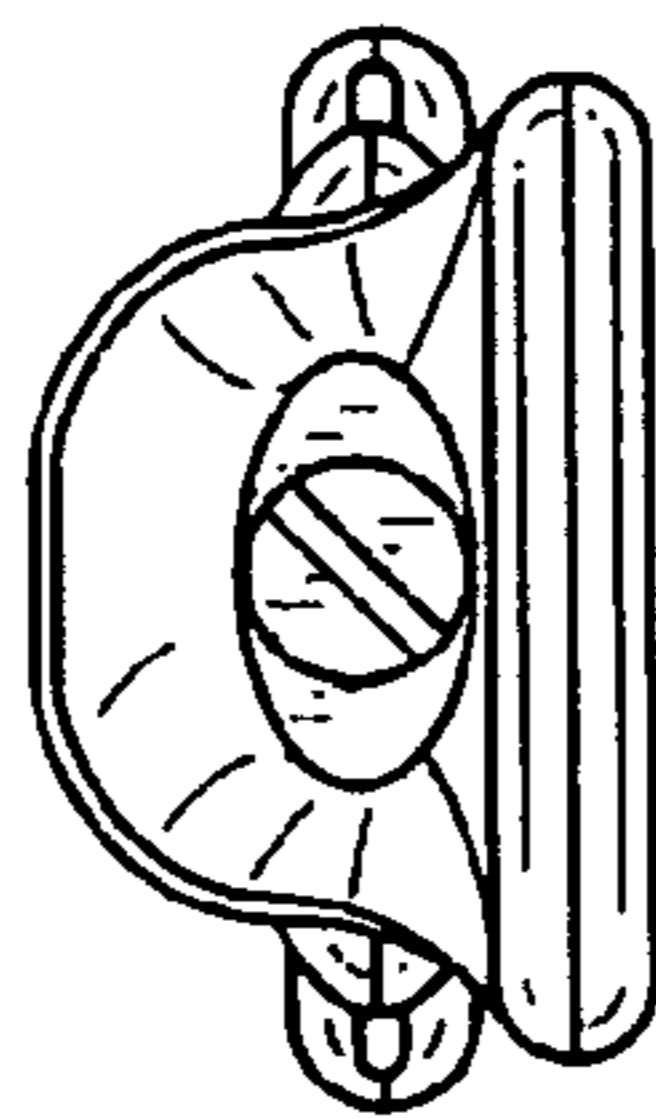

FIG. 2

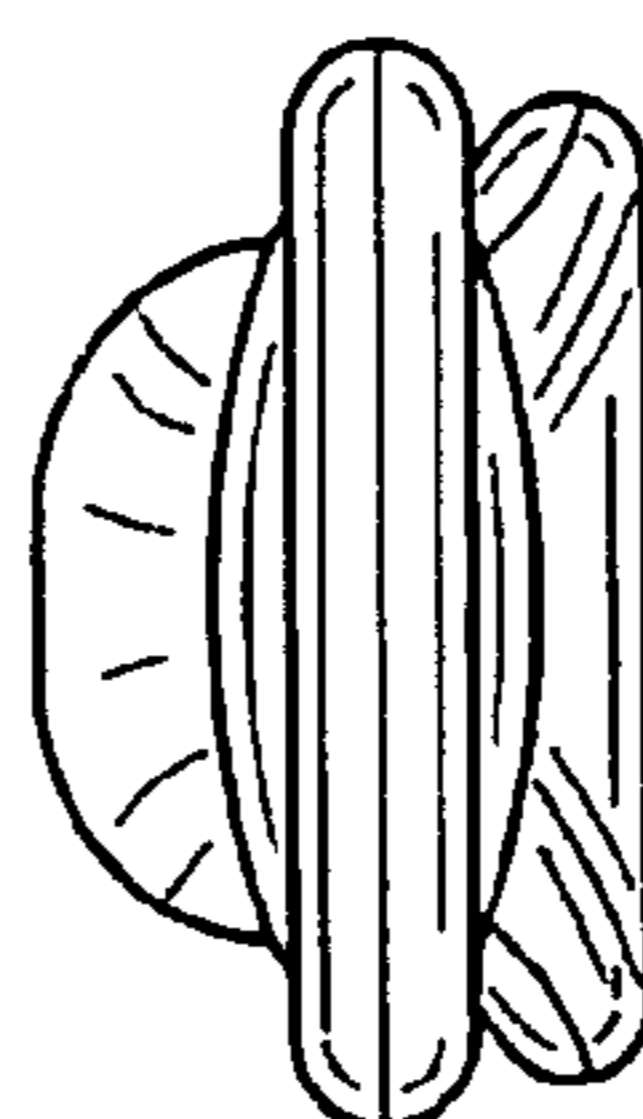

FIG. 3