



US00D595415S

(12) **United States Design Patent**
Fukuzawa

(10) **Patent No.:** **US D595,415 S**
(45) **Date of Patent:** **** Jun. 30, 2009**

(54) **TEST METER**

D550,364 S * 9/2007 Glover et al. D24/186
D551,350 S * 9/2007 Lorimer et al. D24/186
D567,125 S * 4/2008 Okabe et al. D10/81

(75) Inventor: **Masahiro Fukuzawa**, Kyoto (JP)

* cited by examiner

(73) Assignee: **ARKRAY, Inc.**, Kyoto (JP)

Primary Examiner—Robert A. Delehanty

(**) Term: **14 Years**

Assistant Examiner—Mark Cavanna

(21) Appl. No.: **29/327,968**

(74) *Attorney, Agent, or Firm*—Studebaker & Brackett PC;
Donald R. Studebaker

(22) Filed: **Nov. 17, 2008**

(57) **CLAIM**

(30) **Foreign Application Priority Data**

The ornamental design for a test meter, as shown and described.

May 19, 2008 (JP) D2008-012445

(51) **LOC (9) Cl.** **24-01**

DESCRIPTION

(52) **U.S. Cl.** **D24/186**

FIG. 1 is a perspective view of the test meter having a transparent cover;

(58) **Field of Classification Search** D24/169,

FIG. 2 is a front elevational view of the test meter;

D24/186, 231; D10/81; 600/301, 309, 316,
600/318, 322, 324, 347, 365–366, 368, 583–584;
422/55–56, 58, 61, 68.1, 102; 436/66–68

FIG. 3 is a rear elevational view of the test meter;

See application file for complete search history.

FIG. 4 is a left side elevational view of the test meter;

(56) **References Cited**

FIG. 5 is a right side elevational view of the test meter;

U.S. PATENT DOCUMENTS

FIG. 6 is a top plan view of the test meter;

D393,313 S * 4/1998 Meisner et al. D24/169

FIG. 7 is bottom plan view of the test meter;

D444,235 S * 6/2001 Roberts et al. D24/169

FIG. 8 is a perspective view of the test meter emphasizing the transparent cover; and,

D484,600 S * 12/2003 Kaar et al. D24/169

FIG. 9 is a perspective view of the test meter without the transparent cover.

D495,418 S * 8/2004 Rounds et al. D24/169

The broken lines showing various surface details in FIGS. 3–7 are for the purpose of illustration only and form no part of the claimed design.

D537,164 S * 2/2007 Shigemori et al. D24/138

D545,438 S * 6/2007 Huang et al. D24/186

D546,216 S 7/2007 Bolognesi et al.

D546,454 S * 7/2007 Gutmann et al. D24/169

D546,457 S * 7/2007 Hannant et al. D24/186

D546,458 S * 7/2007 Hannant D24/186

D549,830 S * 8/2007 Behar et al. D24/186

1 Claim, 5 Drawing Sheets

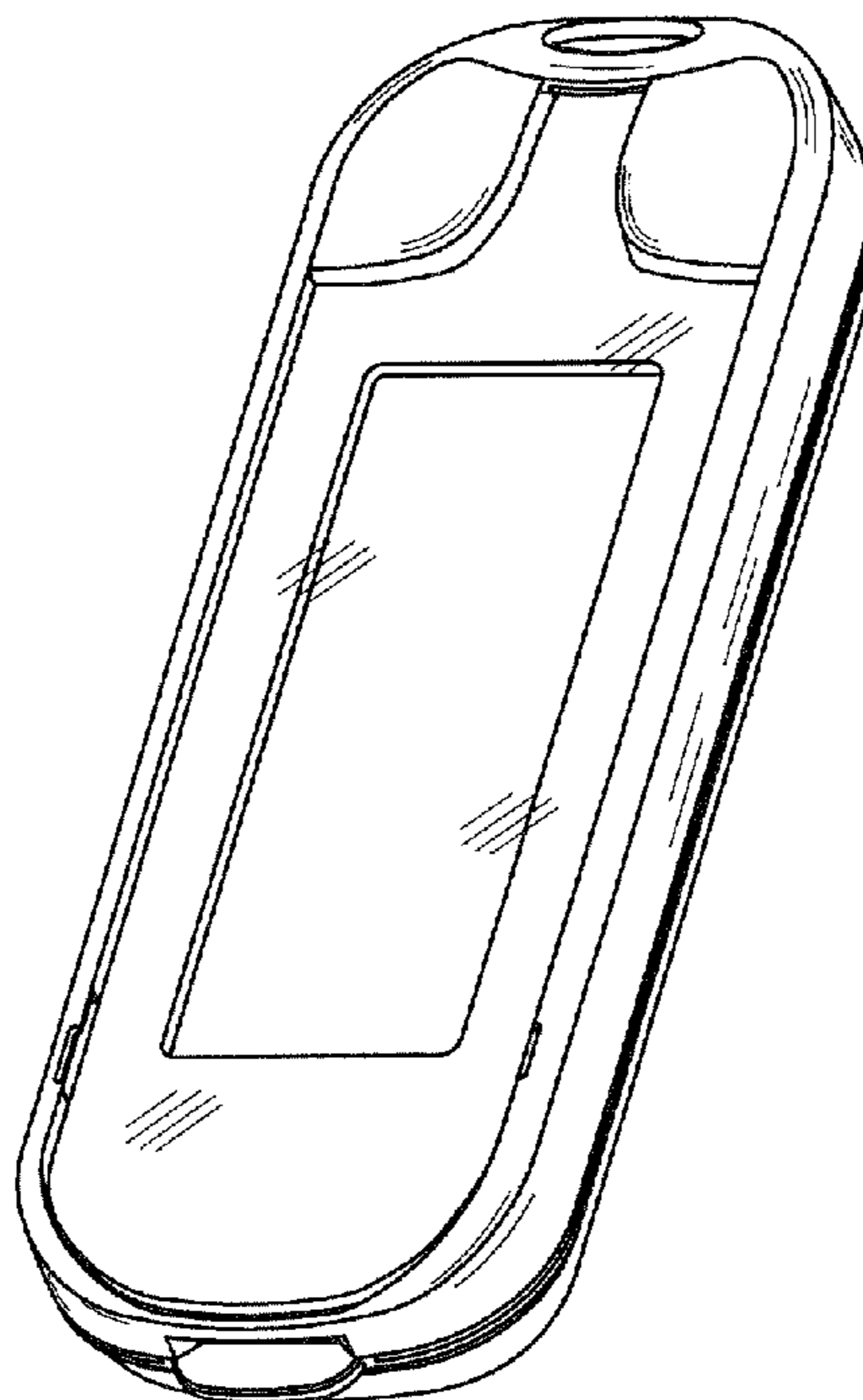

FIG. 1

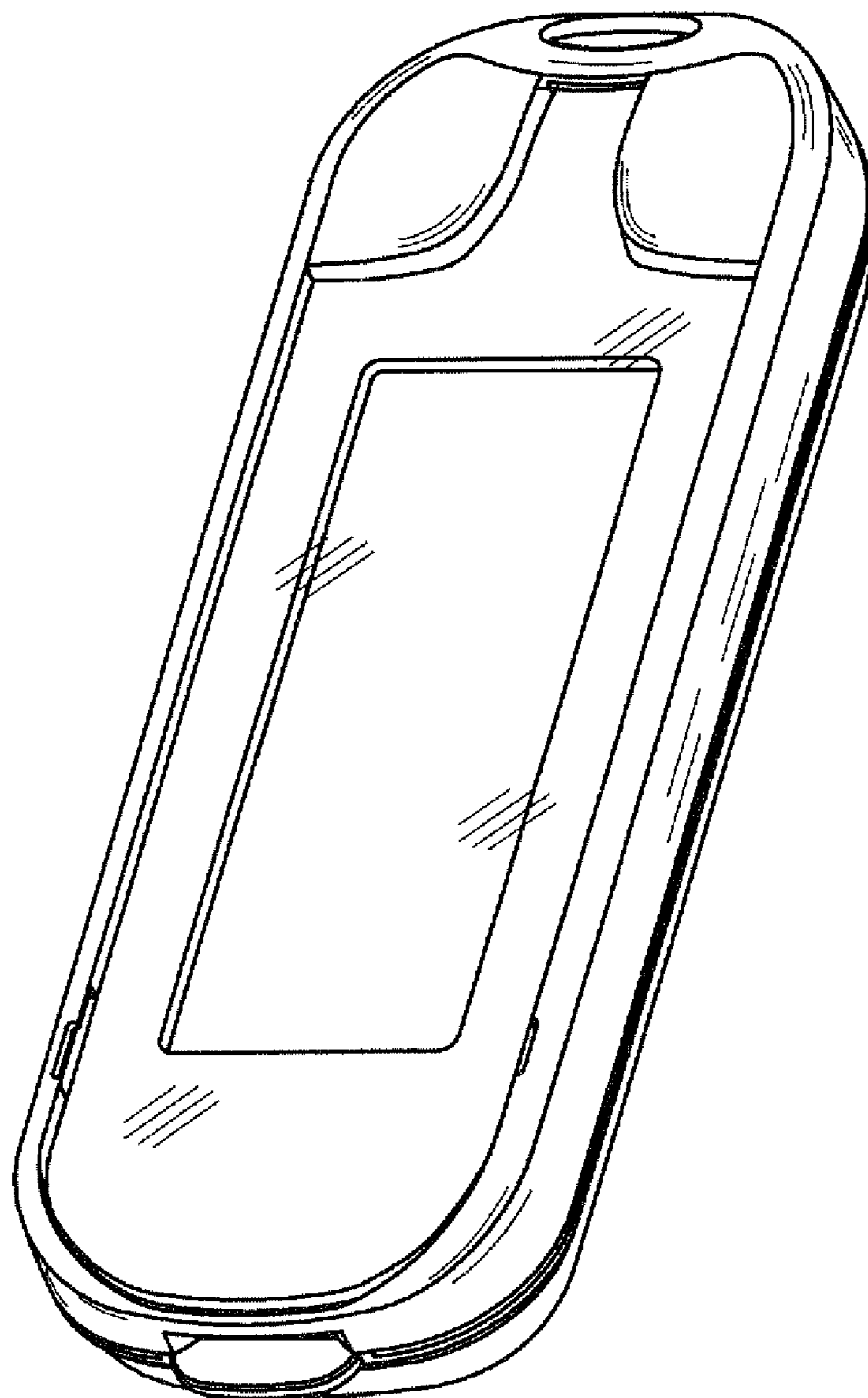

FIG.2

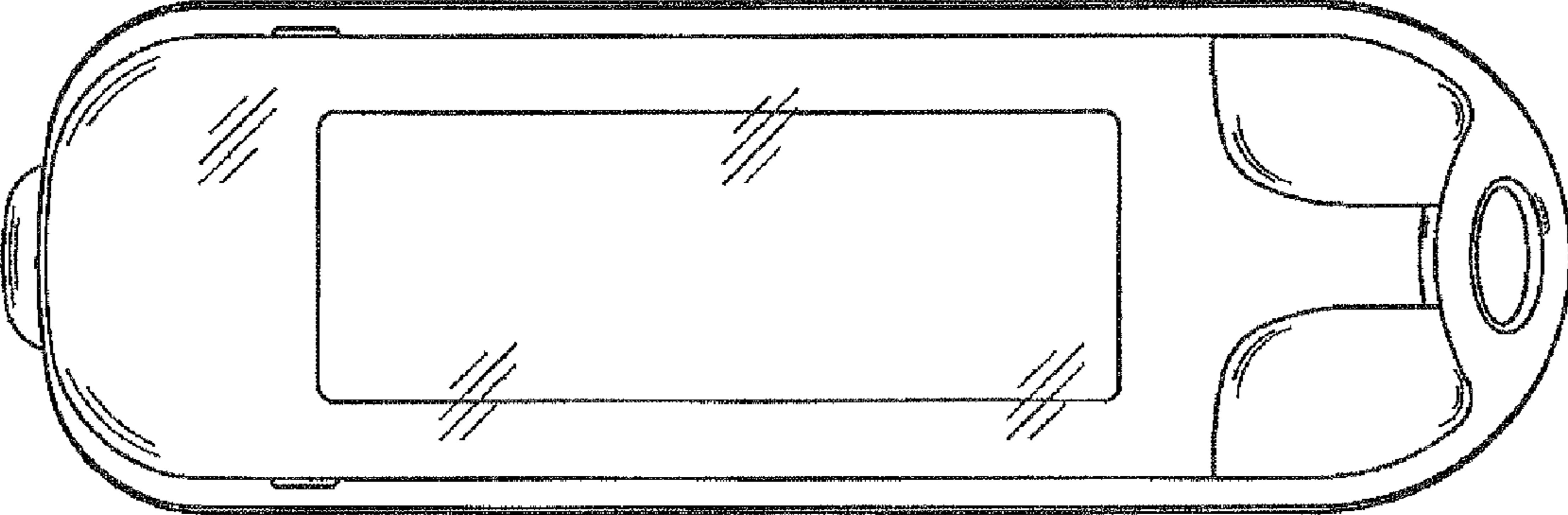

FIG.3

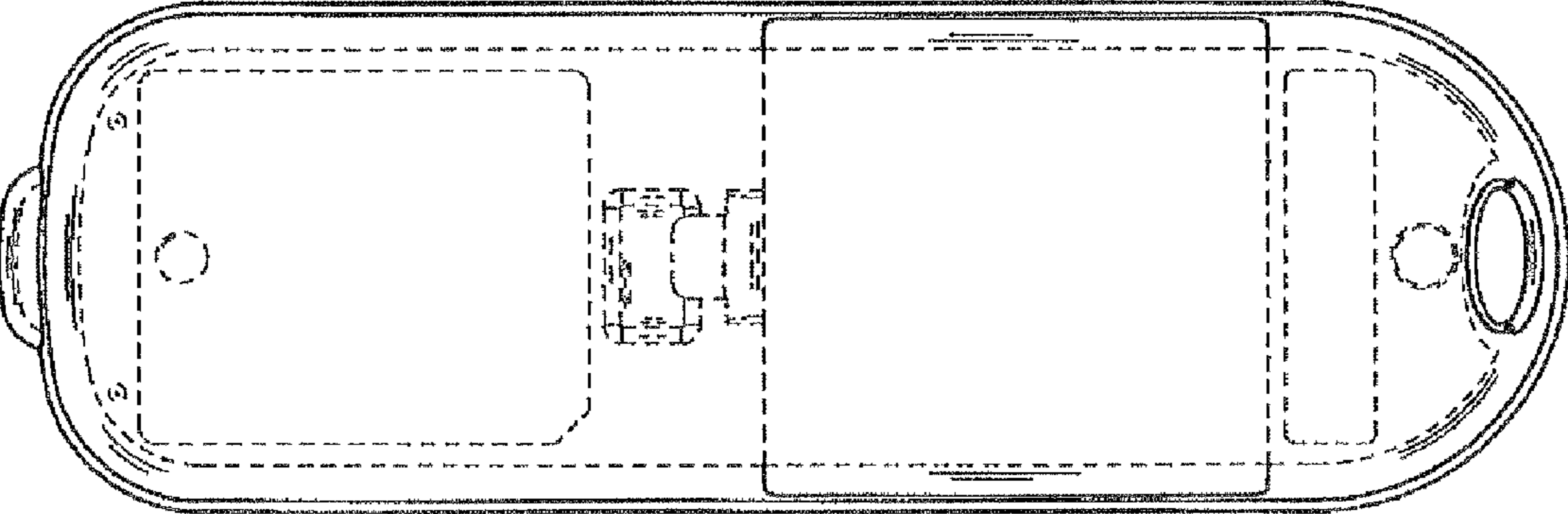

FIG.4

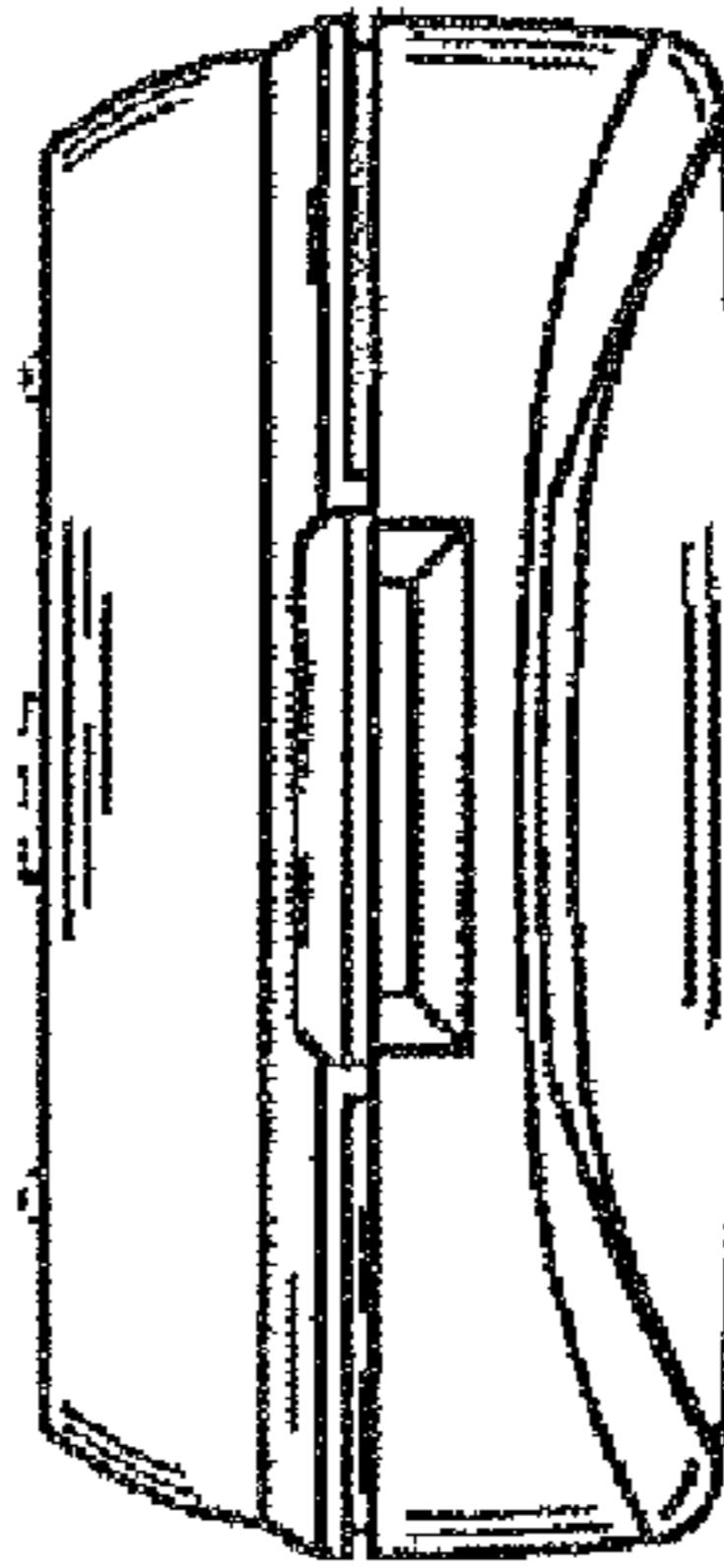

FIG.5

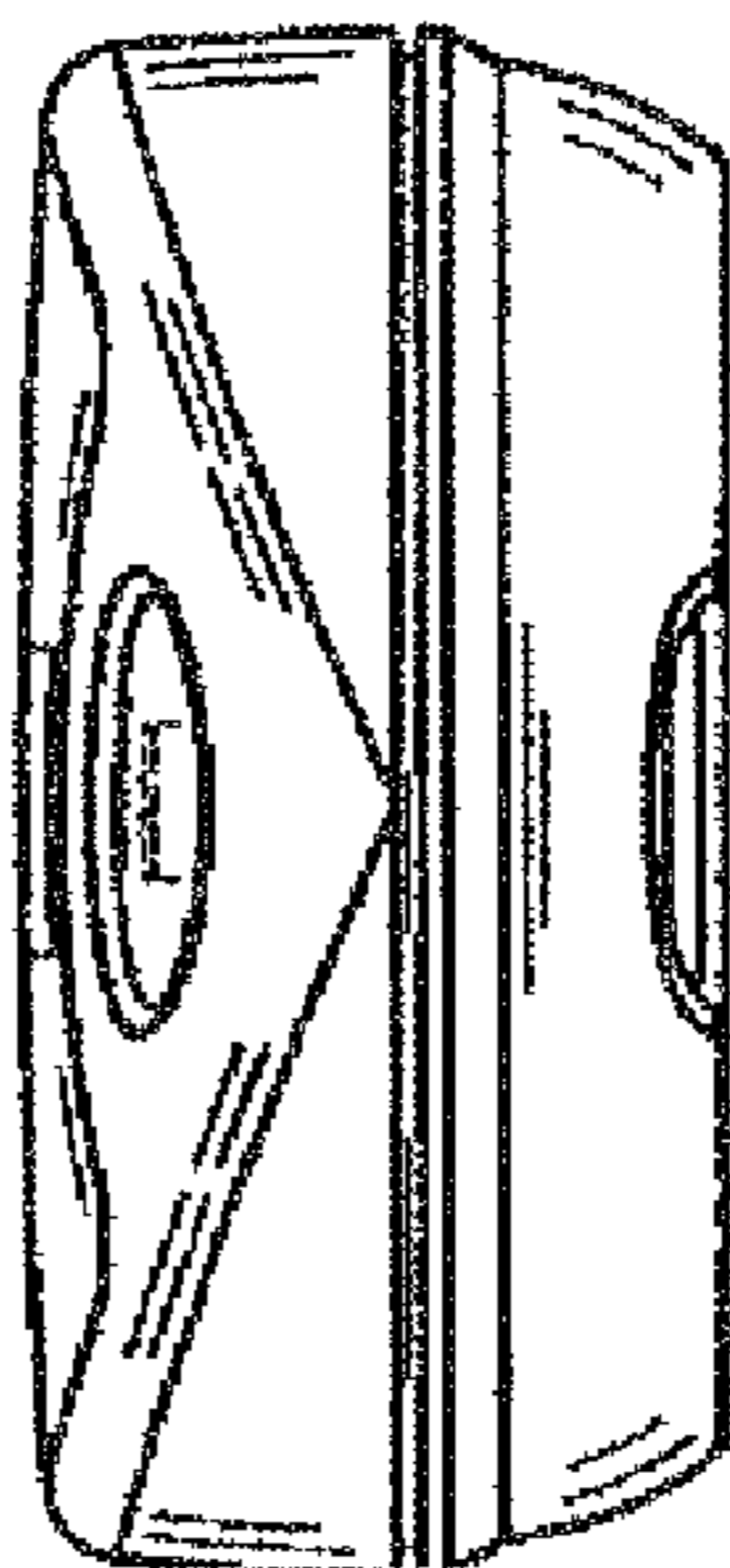

FIG. 6

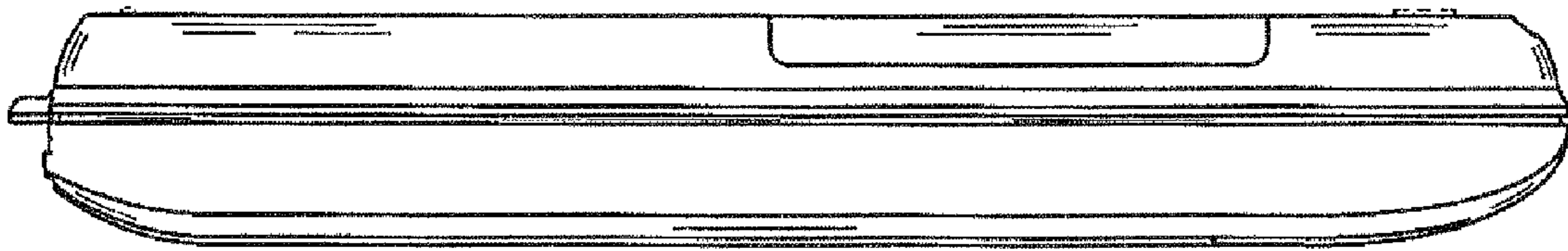

FIG. 7

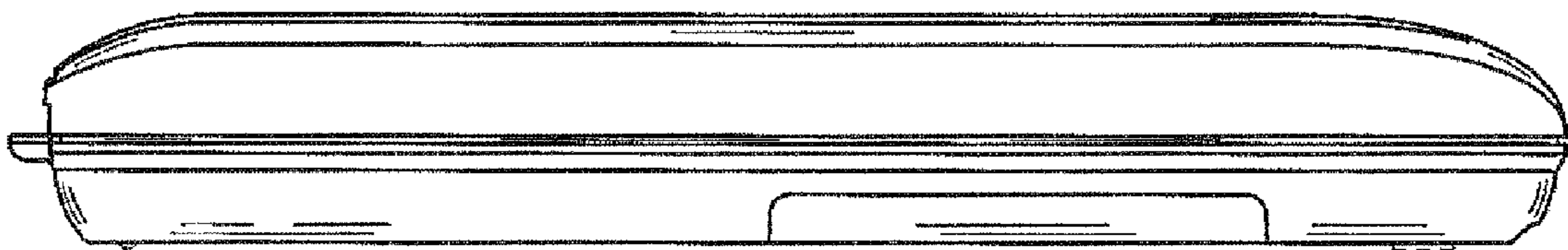

FIG.8

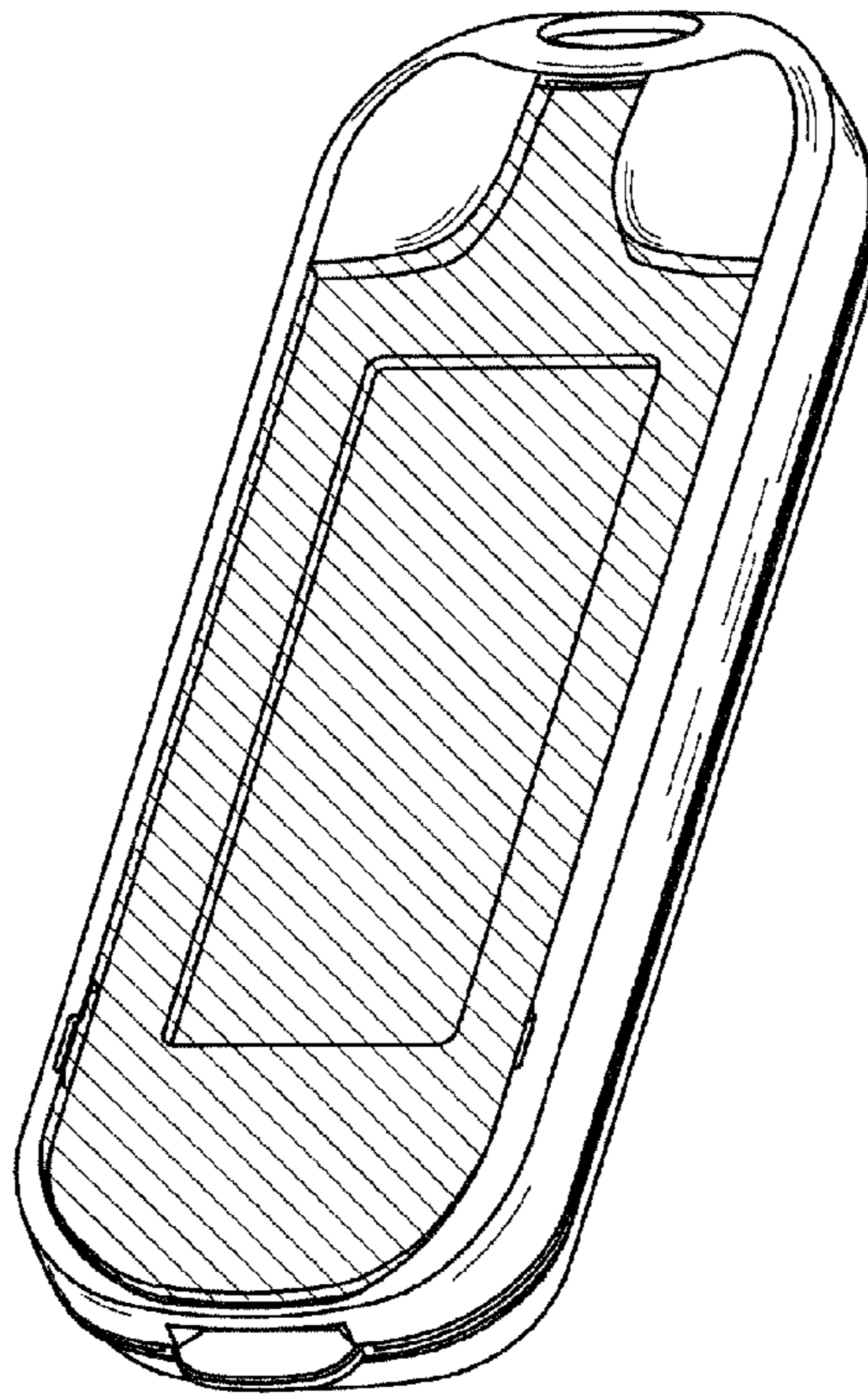

FIG.9

