



US00D595325S

(12) **United States Design Patent**  
**Miyashita et al.**

(10) **Patent No.:** **US D595,325 S**  
(45) **Date of Patent:** **\*\* Jun. 30, 2009**

(54) **COIL BOBBIN**

(75) Inventors: **Toshihito Miyashita**, Nagano (JP);  
**Hiroshi Hioki**, Nagano (JP)

(73) Assignee: **Sanyo Denki Co., Ltd.**, Tokyo (JP)

(\*\*) Term: **14 Years**

(21) Appl. No.: **29/283,385**

(22) Filed: **Aug. 13, 2007**

(30) **Foreign Application Priority Data**

Feb. 13, 2007 (JP) ..... 2007-003320

(51) **LOC (9) Cl.** ..... **15-09**

(52) **U.S. Cl.** ..... **D15/143**

(58) **Field of Classification Search** ..... D15/1,  
D15/5, 143, 148, 199; 242/443; 310/71,  
310/194; 324/207.13; 335/299; 336/167,  
336/192, 198, 213; 360/103; 439/131, 713  
See application file for complete search history.

(56) **References Cited**

**U.S. PATENT DOCUMENTS**

- 3,750,073 A \* 7/1973 Okano ..... 336/198
- 4,617,543 A \* 10/1986 Akachi et al. .... 336/192
- 5,661,447 A \* 8/1997 Egawa et al. .... 335/299
- 6,046,663 A \* 4/2000 Kubomura et al. .... 336/198
- 6,160,468 A \* 12/2000 Himei ..... 336/198
- 6,507,261 B1 \* 1/2003 Haga et al. .... 336/198
- 6,825,587 B2 \* 11/2004 Yajima et al. .... 310/90
- 7,408,436 B2 \* 8/2008 Ikezawa ..... 336/208
- 2003/0030531 A1 \* 2/2003 Okano et al. .... 336/198
- 2004/0020030 A1 \* 2/2004 Yamamoto et al. .... 29/606

- 2004/0036568 A1 \* 2/2004 Suzuki ..... 336/192
- 2006/0261697 A1 \* 11/2006 Baumgartner et al. .... 310/180
- 2007/0096583 A1 \* 5/2007 Welke et al. .... 310/214
- 2007/0171023 A1 \* 7/2007 Ikezawa ..... 336/208
- 2009/0051234 A1 \* 2/2009 Yamane et al. .... 310/71
- 2009/0058251 A1 \* 3/2009 Ham ..... 313/242

**FOREIGN PATENT DOCUMENTS**

- JP 874248 8/1993
- JP 960841 8/1996
- JP 960842 8/1996
- JP 3811179 6/2006

\* cited by examiner

*Primary Examiner*—Sandra Snapp

*Assistant Examiner*—Patricia Palasik

(74) *Attorney, Agent, or Firm*—Rankin, Hill & Clark LLP

(57) **CLAIM**

The ornamental design for a coil bobbin, as shown and described.

**DESCRIPTION**

FIG. 1 is a front elevation view of the coil bobbin.

FIG. 2 is a rear elevation view.

FIG. 3 is a right side elevation view.

FIG. 4 is a left side elevation view.

FIG. 5 is a top plan view.

FIG. 6 is a bottom plan view.

FIG. 7 is a cross-sectional view, as taken along line 7—7 of FIG. 4; and,

FIG. 8 is a perspective view.

**1 Claim, 8 Drawing Sheets**

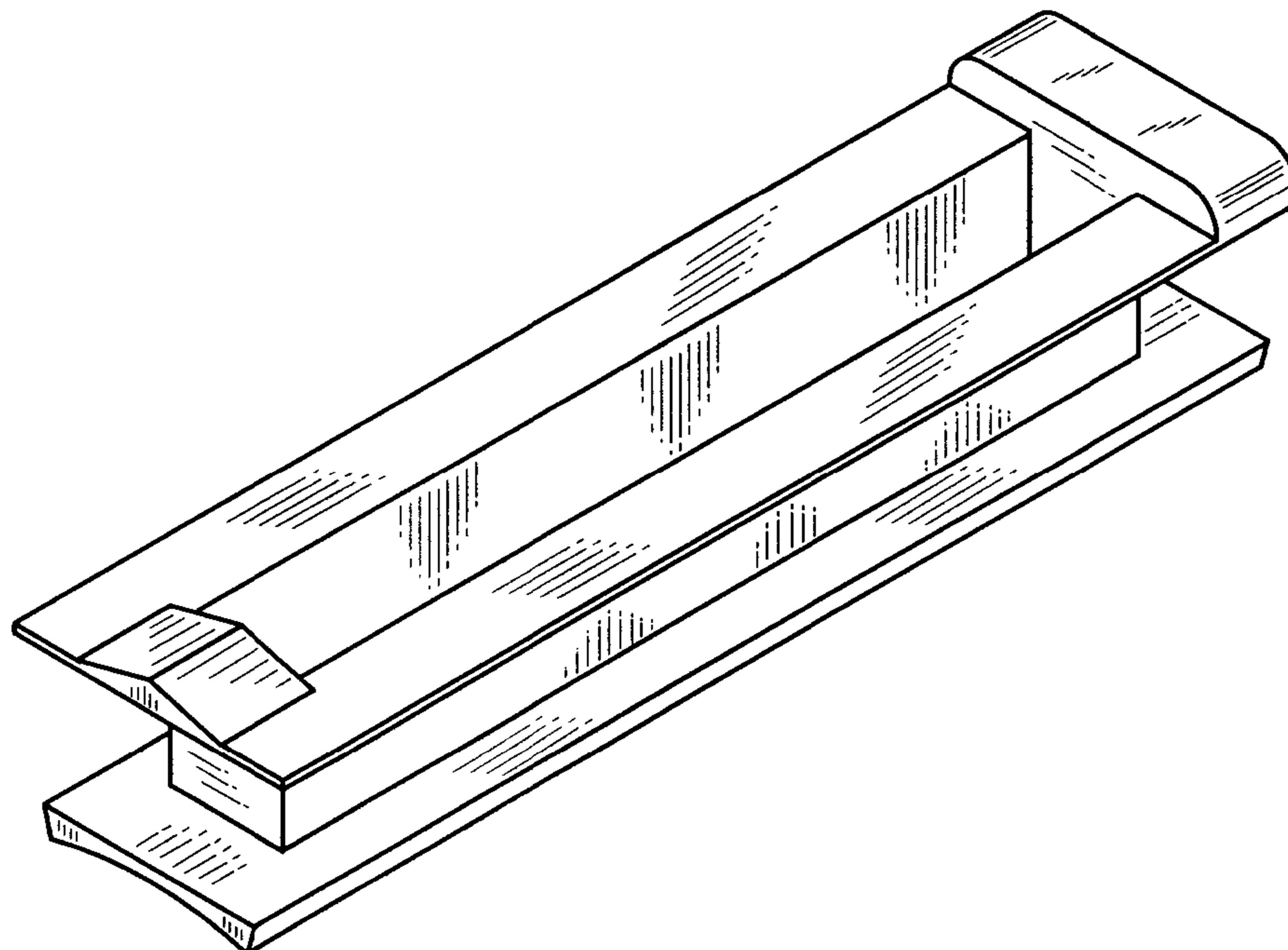

# *Fig. 1*

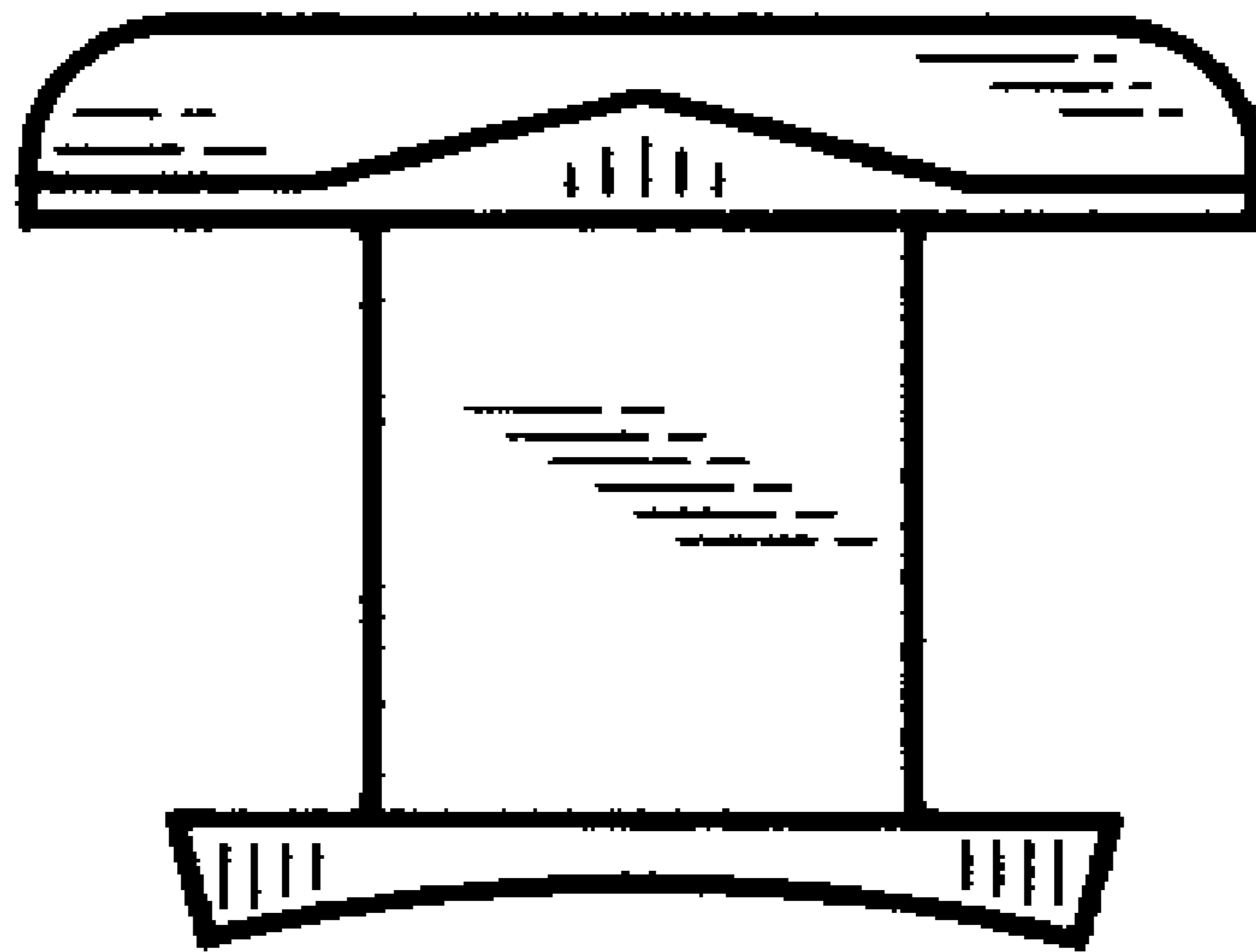

*Fig. 2*

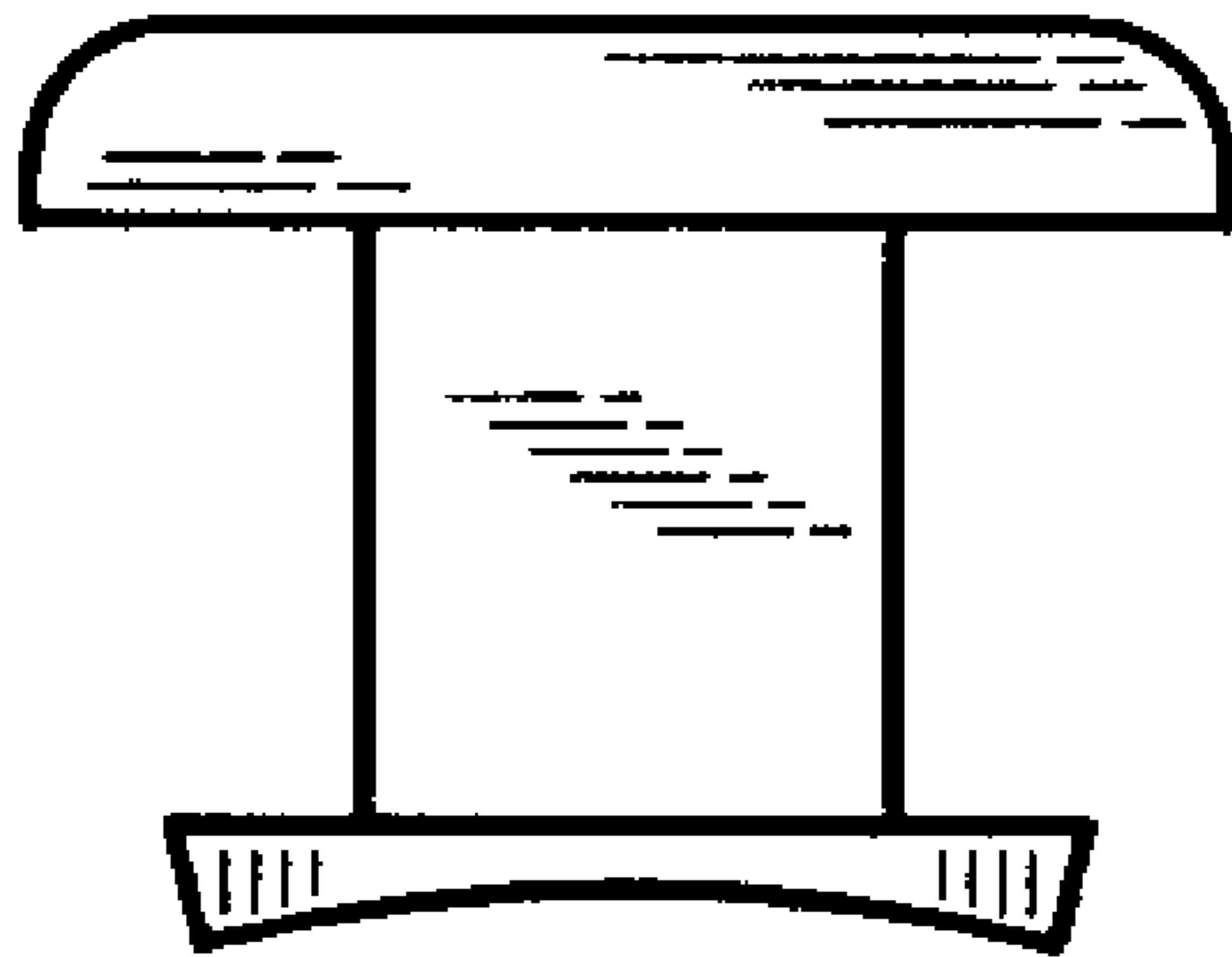

*Fig. 3*

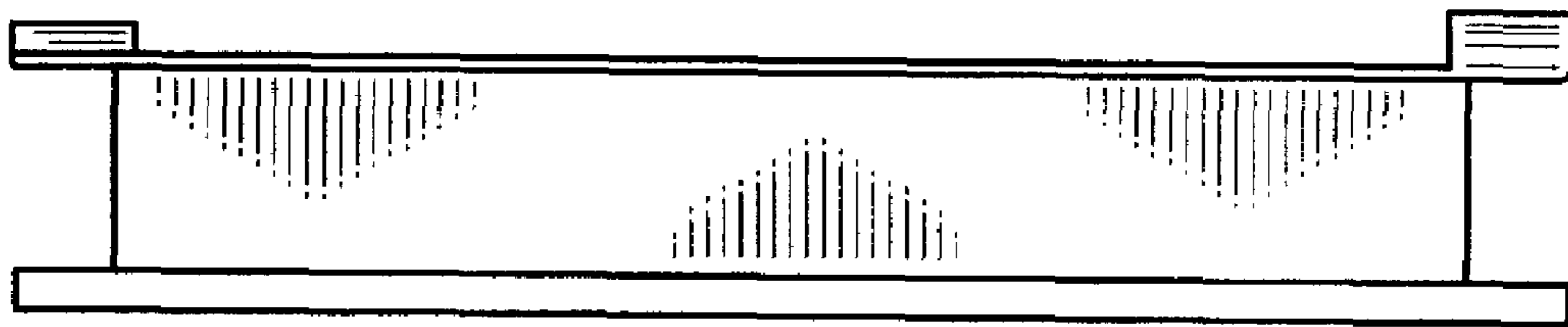

*Fig. 4*

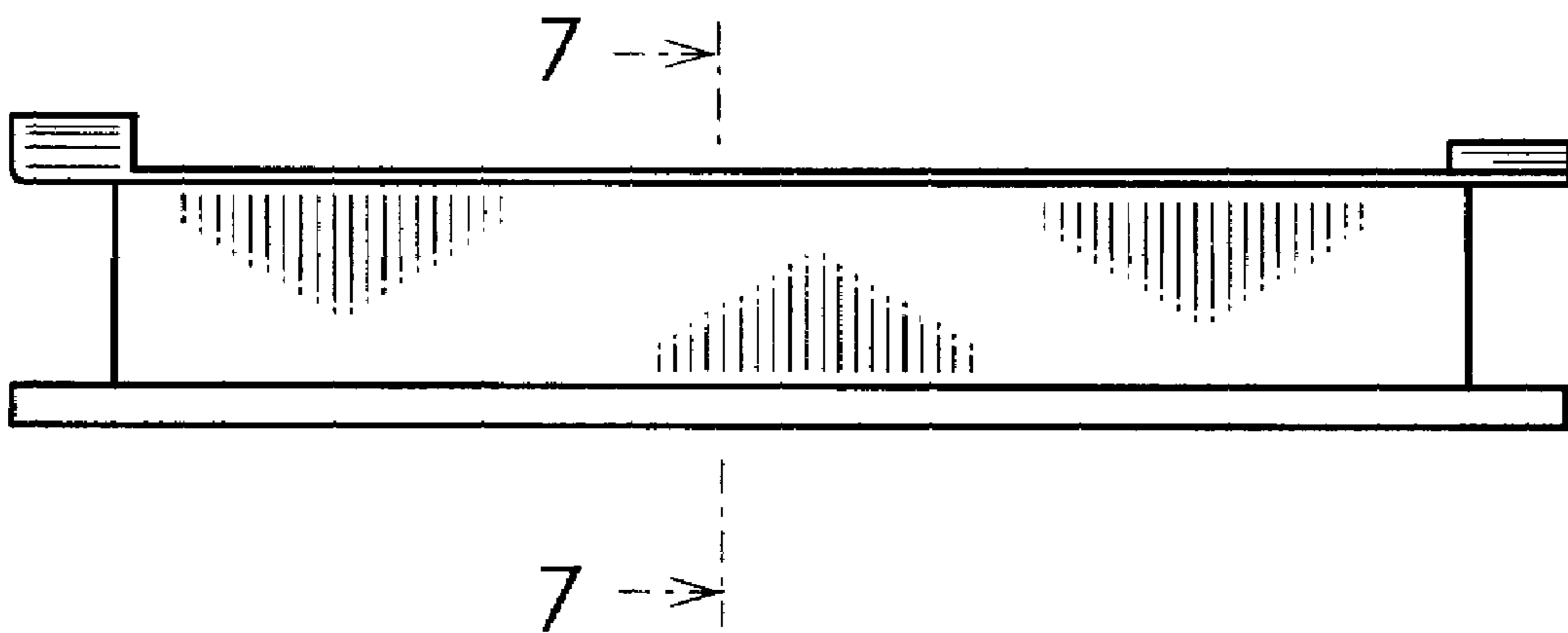

*Fig. 5*

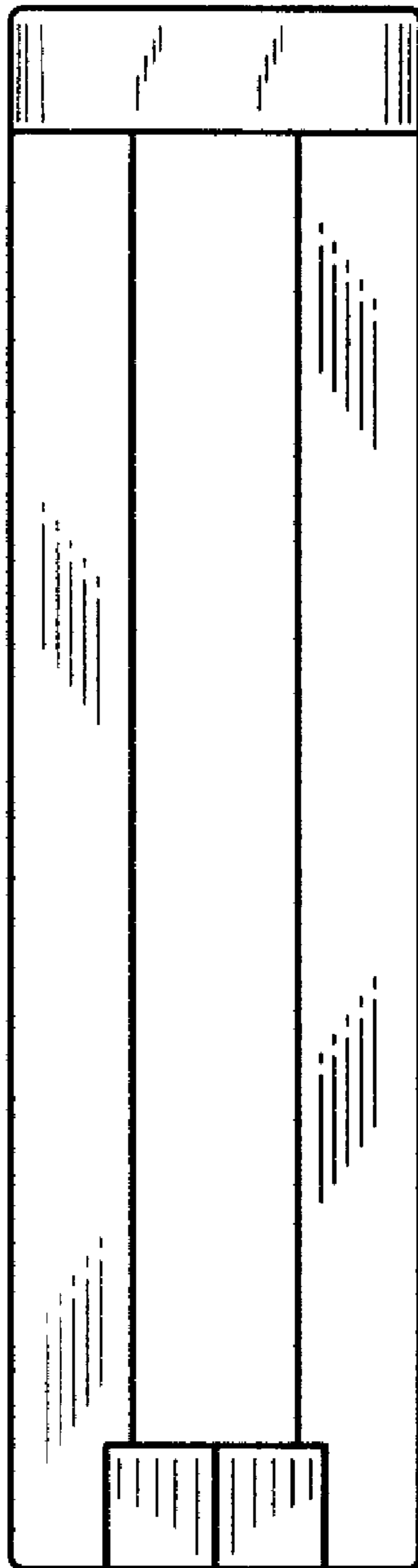

*Fig. 6*

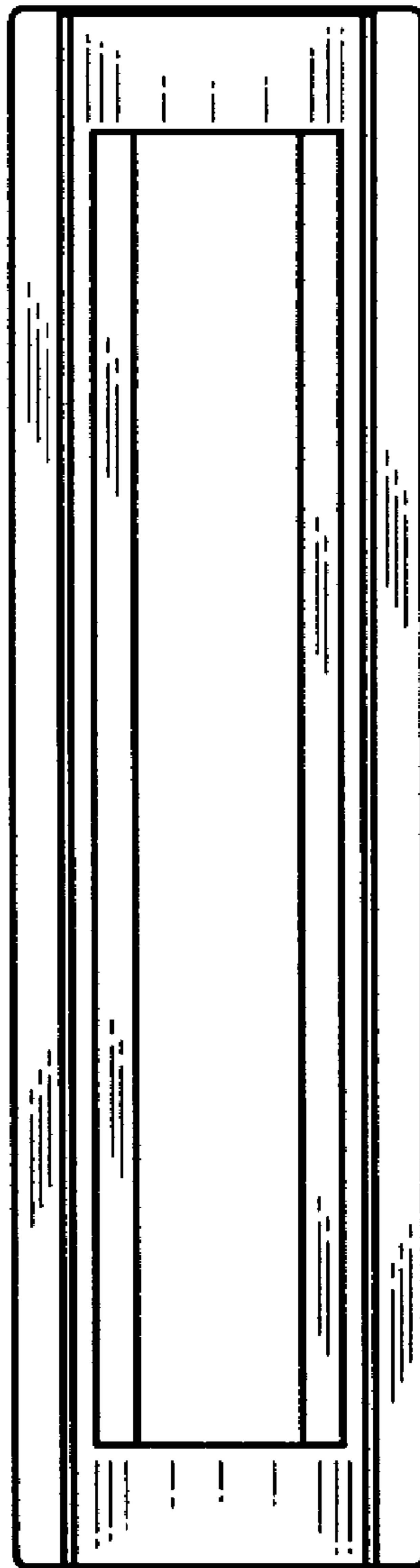

*Fig. 7*

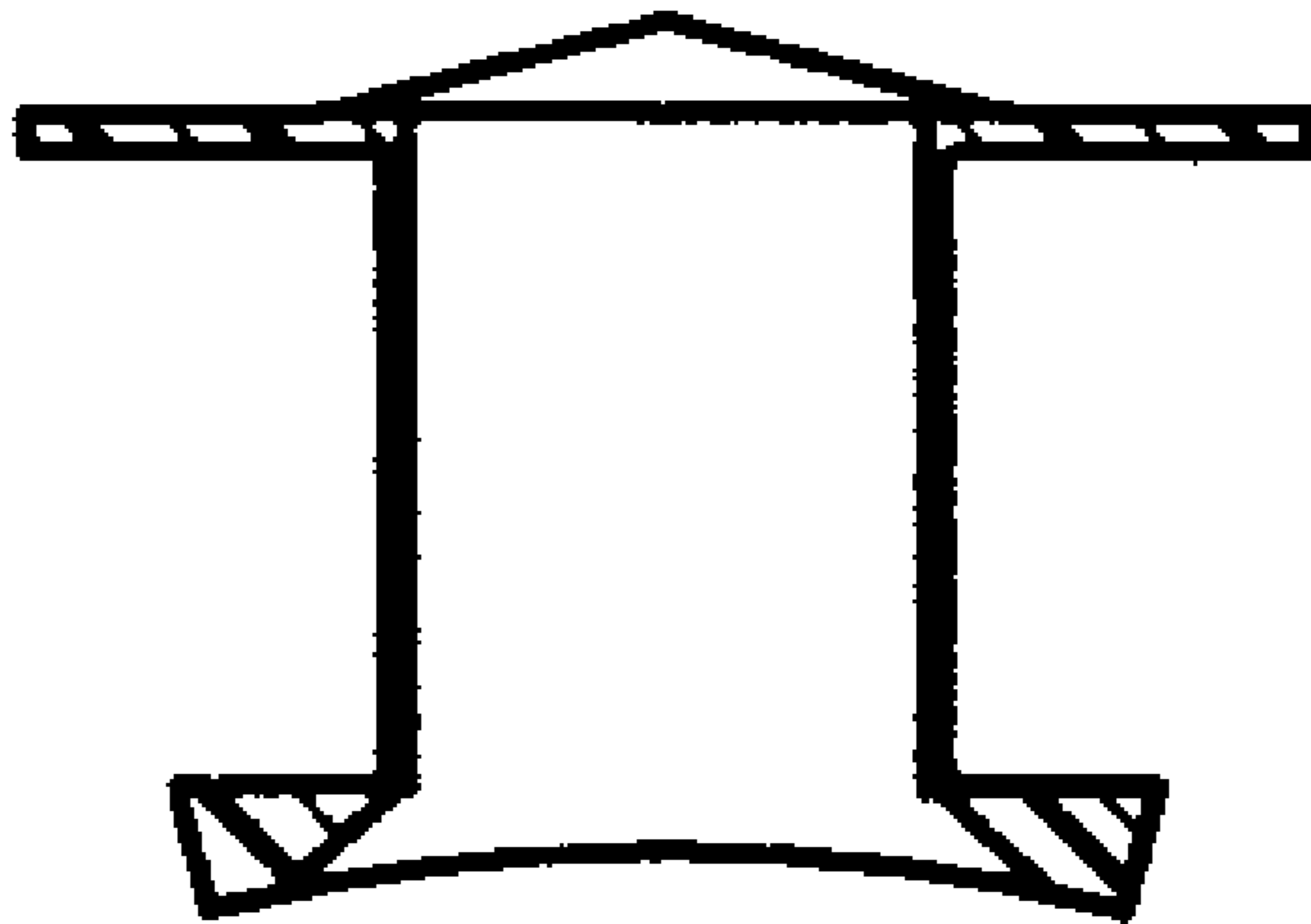



*Fig. 8*

