



US00D595290S

(12) **United States Design Patent**  
**Takemasa**

(10) **Patent No.:** **US D595,290 S**  
(45) **Date of Patent:** **\*\* Jun. 30, 2009**

(54) **PORTABLE COMPUTER**

D453,757 S \* 2/2002 Maio et al. .... D14/340

(75) Inventor: **Hirofumi Takemasa**, Kadoma (JP)

(Continued)

(73) Assignee: **Panasonic Corporation**, Kadoma-shi (JP)

FOREIGN PATENT DOCUMENTS

(\*\*) Term: **14 Years**

(21) Appl. No.: **29/306,542**

(22) Filed: **Apr. 10, 2008**

(30) **Foreign Application Priority Data**

Jan. 9, 2008 (JP) ..... 2008-002221

JP	D1167903 S	3/2003
JP	D1171386 S	4/2003
JP	D1175904 S	6/2003
JP	D1176837 S	6/2003
JP	D1178496 S	7/2003
JP	D1178678 S	7/2003
JP	D1179350 S	7/2003
JP	D1179351 S	7/2003
JP	D1179857 S	7/2003
JP	D1184963 S	9/2003
JP	D1186898 S	10/2003
JP	D1187520 S	10/2003
JP	D1187554 S	10/2003
JP	D1188021 S	10/2003

(51) **LOC (9) Cl.** ..... **14-02**

(52) **U.S. Cl.** ..... **D14/346**

(58) **Field of Classification Search** ..... D14/341, D14/342, 343, 344, 345, 346, 347, 138 R, D14/138 AA, 138 AB, 138 AC, 138 AD, D14/138 C, 138 G, 315, 316, 320, 331, 333, D14/334, 335, 338, 339, 340, 387, 390, 391, D14/392, 393, 394, 395, 396, 397, 398, 399, D14/400, 401, 406, 420, 426, 427, 428, 429, D14/432, 439, 440, 441, 453, 454, 455, 456, D14/457, 496, 130, 137, 142, 150, 151, 203.1; D14/203.3, 203.4, 203.5, 203.6, 203.7, 238.1, D14/247, 248, 250, 902, 218, 125, 126; D13/168, D13/171; D18/7; D21/324, 329, 330, 331, D21/333; D10/65; 455/556.1, 556.2, 566, 455/575.1, 575.3, 575.4, 90.3; 341/22; 379/433.04, 379/433.06, 433.07, 433.11, 433.12, 433.13, 379/910, 915, 916; 348/14.02, 207.1, 552; 345/169, 168, 901

(Continued)

*Primary Examiner*—Jennifer Rivard  
*Assistant Examiner*—Angela J Lee  
(74) *Attorney, Agent, or Firm*—Christensen O'Connor Johnson Kindness PLLC

See application file for complete search history.

(56) **References Cited**

U.S. PATENT DOCUMENTS

D359,753 S	*	6/1995	Salinas et al.	.....	D18/19
D366,220 S	*	1/1996	Sakamoto	.....	D10/65
D416,256 S	*	11/1999	Griffin et al.	.....	D14/191
D433,018 S	*	10/2000	Tanimura et al.	.....	D14/346

(57) **CLAIM**

The ornamental design for a portable computer, as shown and described.

**DESCRIPTION**

FIG. 1 is a front perspective view of the front, right side and top plan view of a portable computer showing my new design; FIG. 2 is a rear perspective view thereof; FIG. 3 is a front view thereof; FIG. 4 is a top plan view thereof; FIG. 5 is a left side view thereof; FIG. 6 is a right side view thereof; FIG. 7 is a bottom view thereof; and, FIG. 8 is a rear view thereof.

**1 Claim, 4 Drawing Sheets**

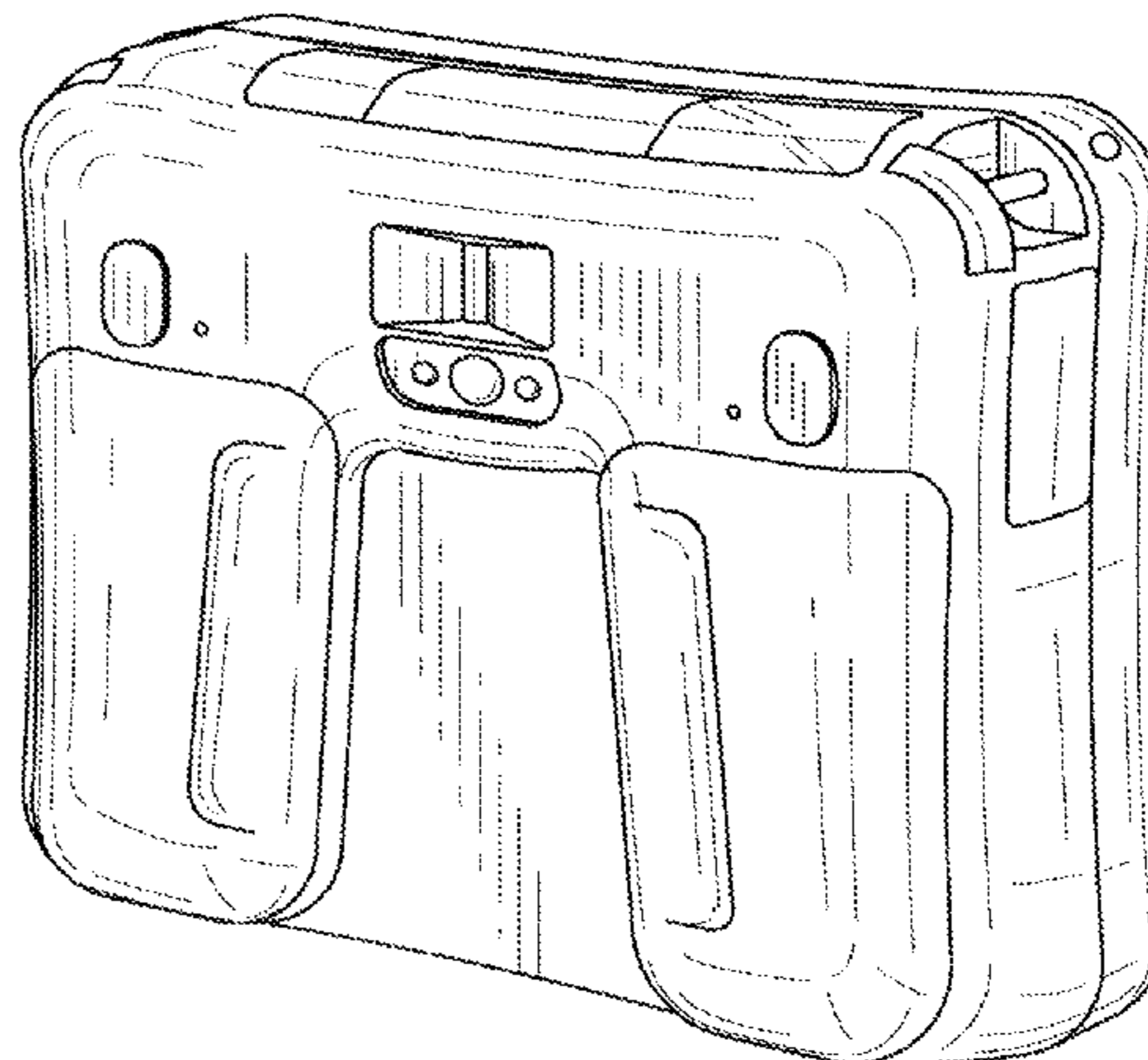
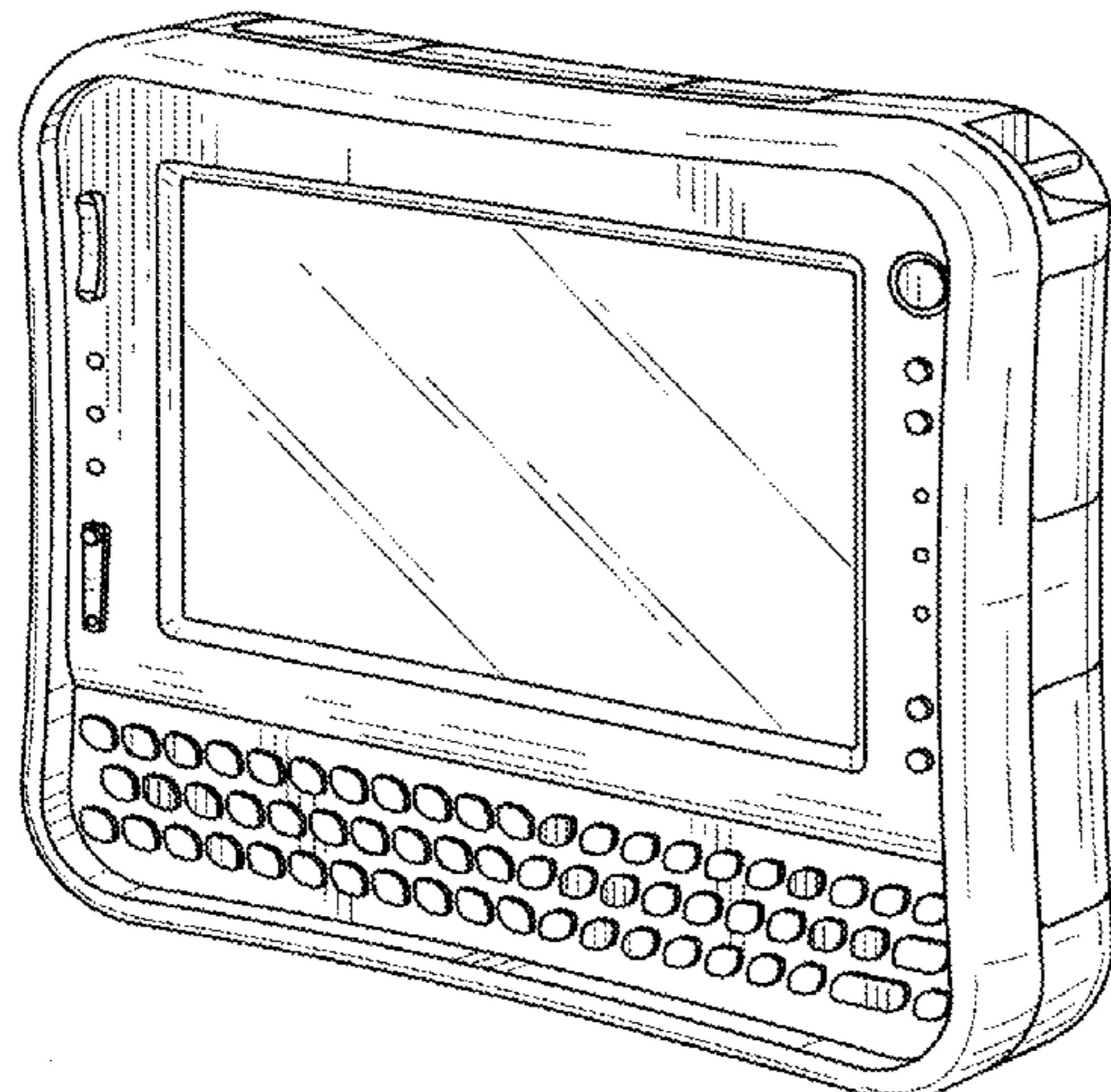

# US D595,290 S

Page 2

---

## U.S. PATENT DOCUMENTS

D506,195 S	6/2005	Leveridge	
D509,827 S *	9/2005	Johnson .....	D14/374
D551,665 S *	9/2007	Tom et al. ....	D14/346
D564,471 S *	3/2008	Lee .....	D14/126
D569,373 S *	5/2008	Lee et al. ....	D14/341
D570,347 S *	6/2008	Kataoka et al. ....	D14/341
D571,799 S *	6/2008	Ogasawara .....	D14/341
D572,675 S *	7/2008	Qiu et al. ....	D14/126
2004/0023696 A1 *	2/2004	Kim .....	455/566

## FOREIGN PATENT DOCUMENTS

JP	D1189007 S	11/2003
JP	D1212545 S	7/2004
JP	D1217831 S	9/2004
JP	D1224642 S	12/2004
JP	D1225623 S	12/2004
JP	D1246384 S	8/2005
JP	D1246869 S	8/2005
JP	D1260932 S	4/2008

\* cited by examiner

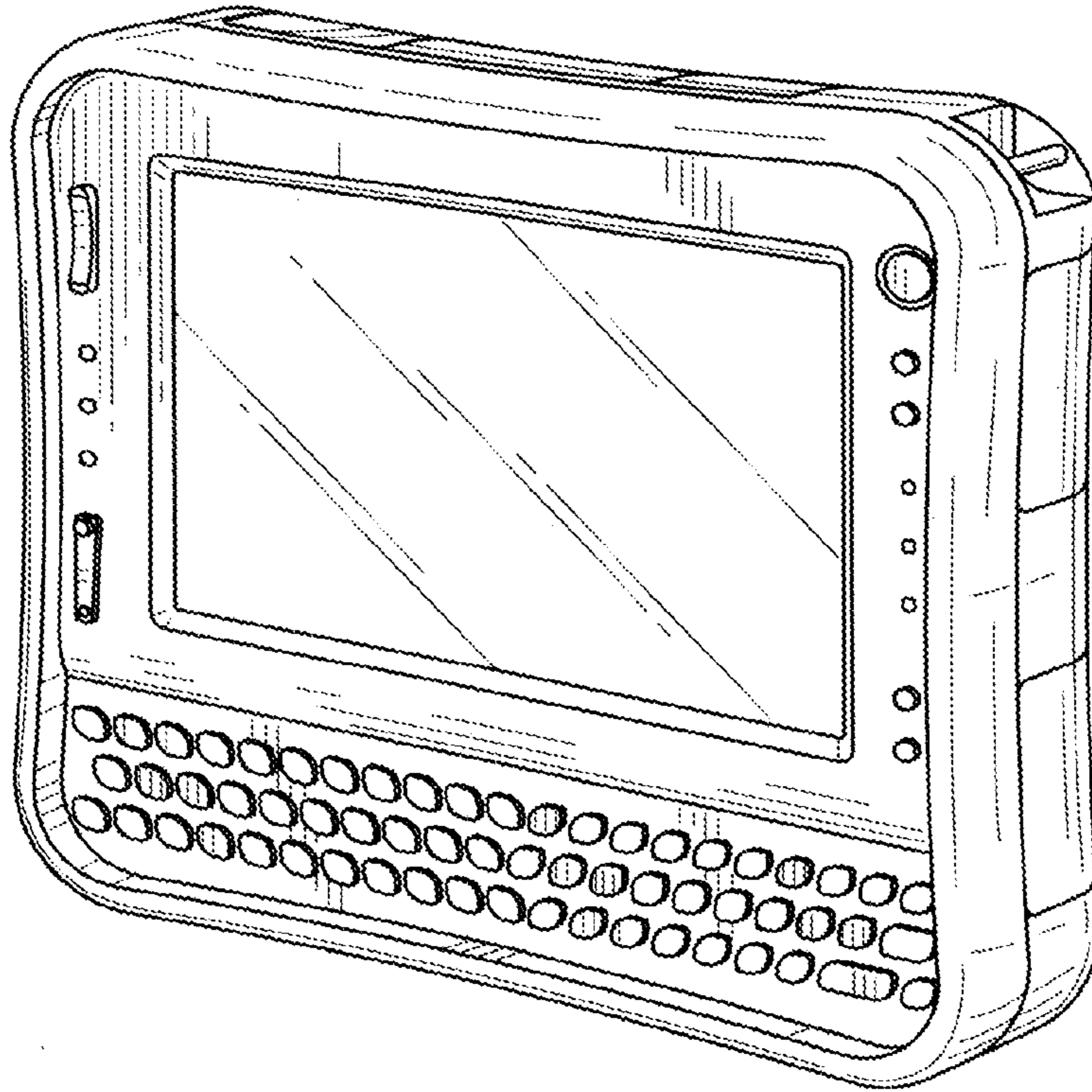

*Fig. 1.*

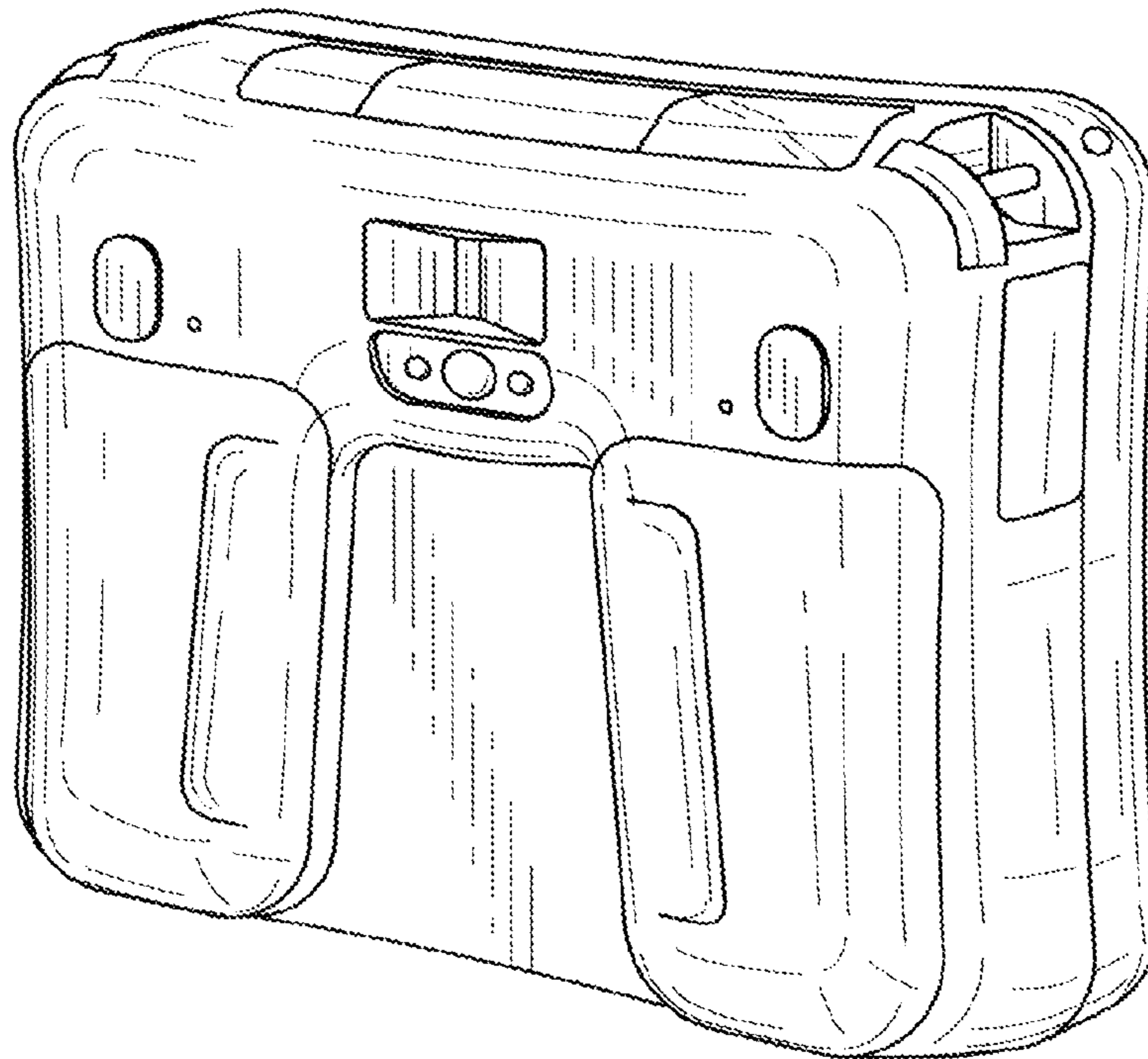

*Fig. 2.*

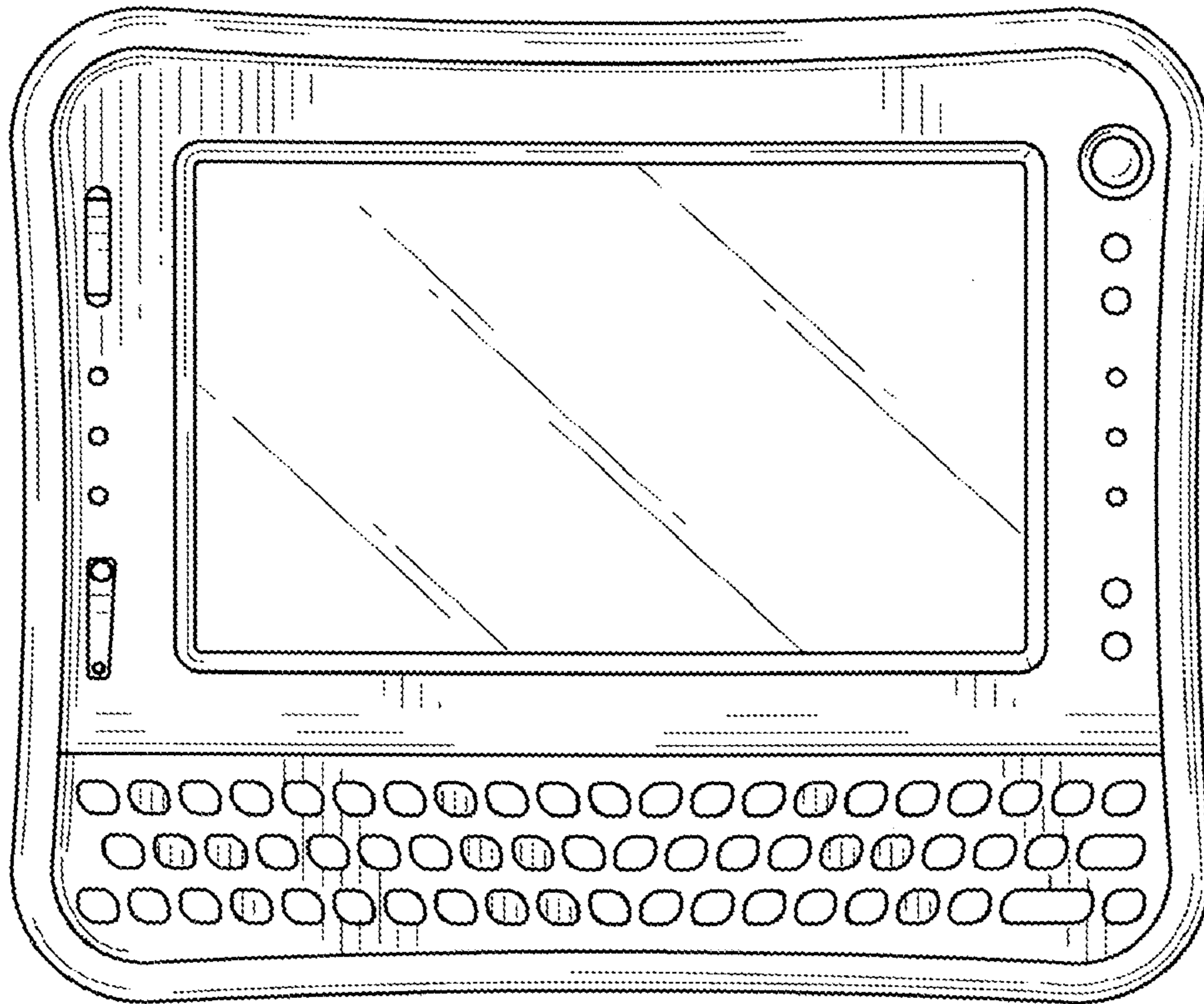

*Fig.3.*

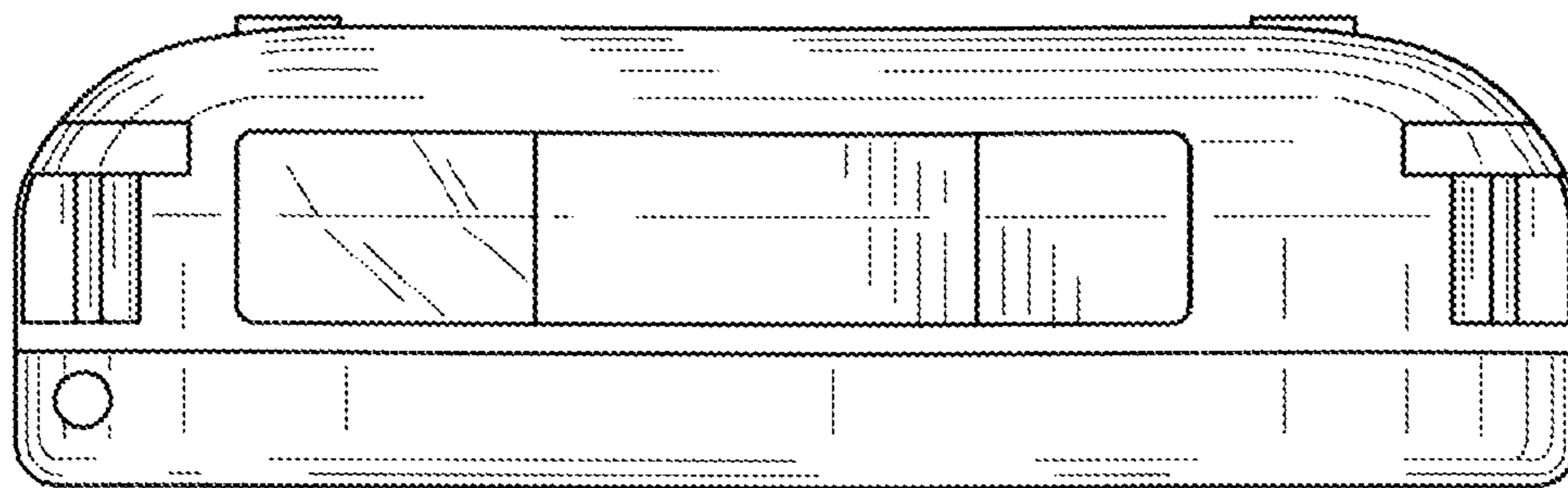

*Fig.4.*

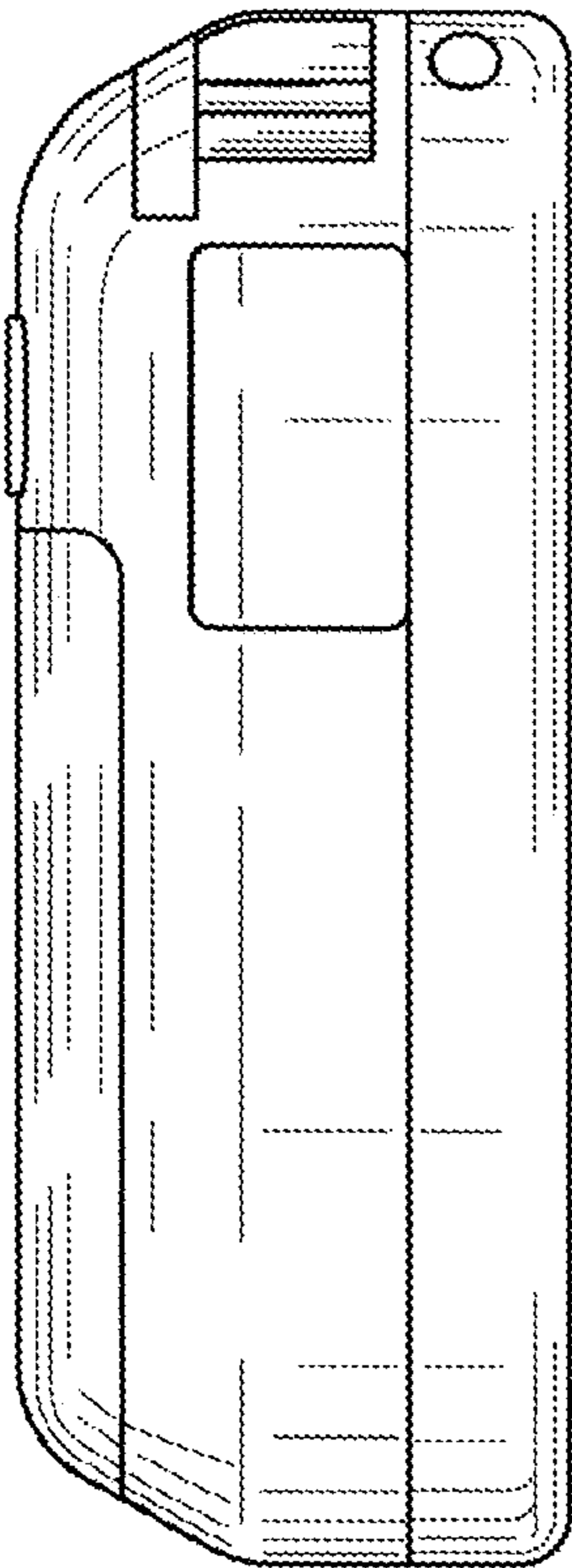

***Fig. 5.***

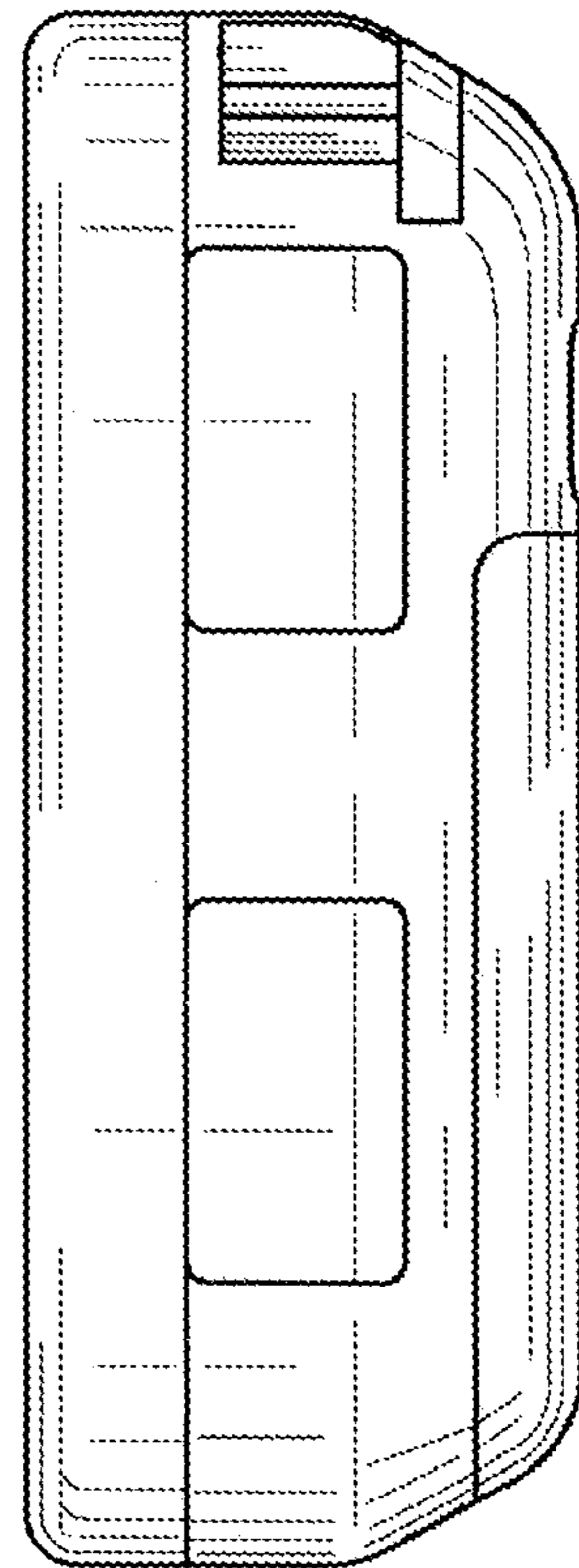

***Fig. 6.***

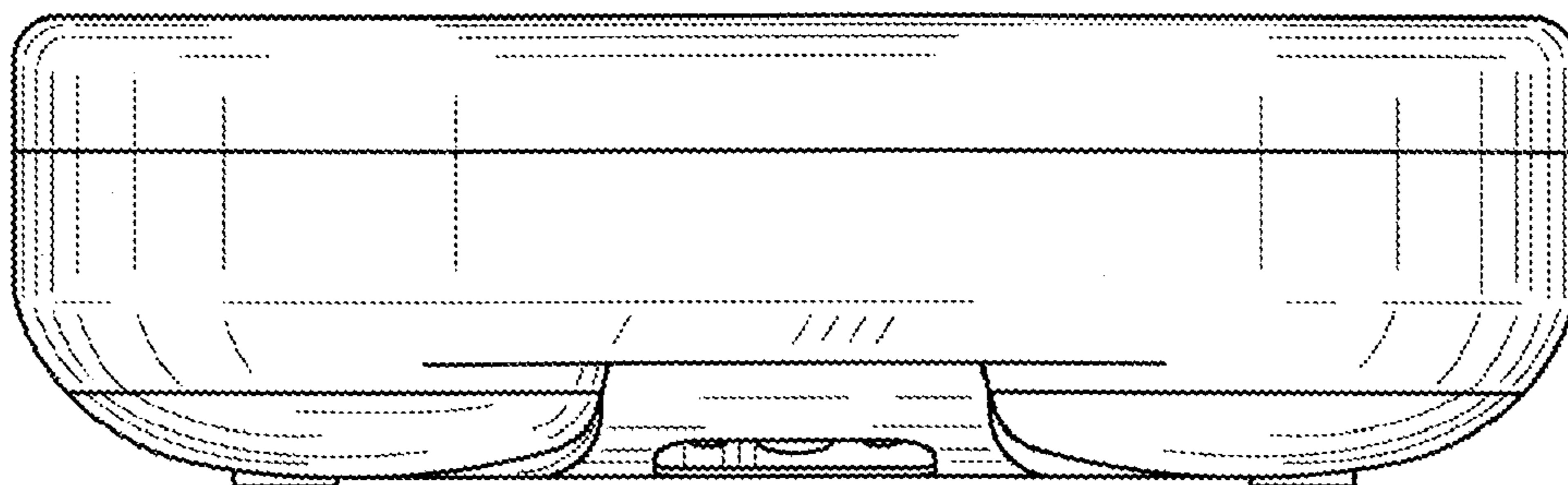

***Fig. 7.***

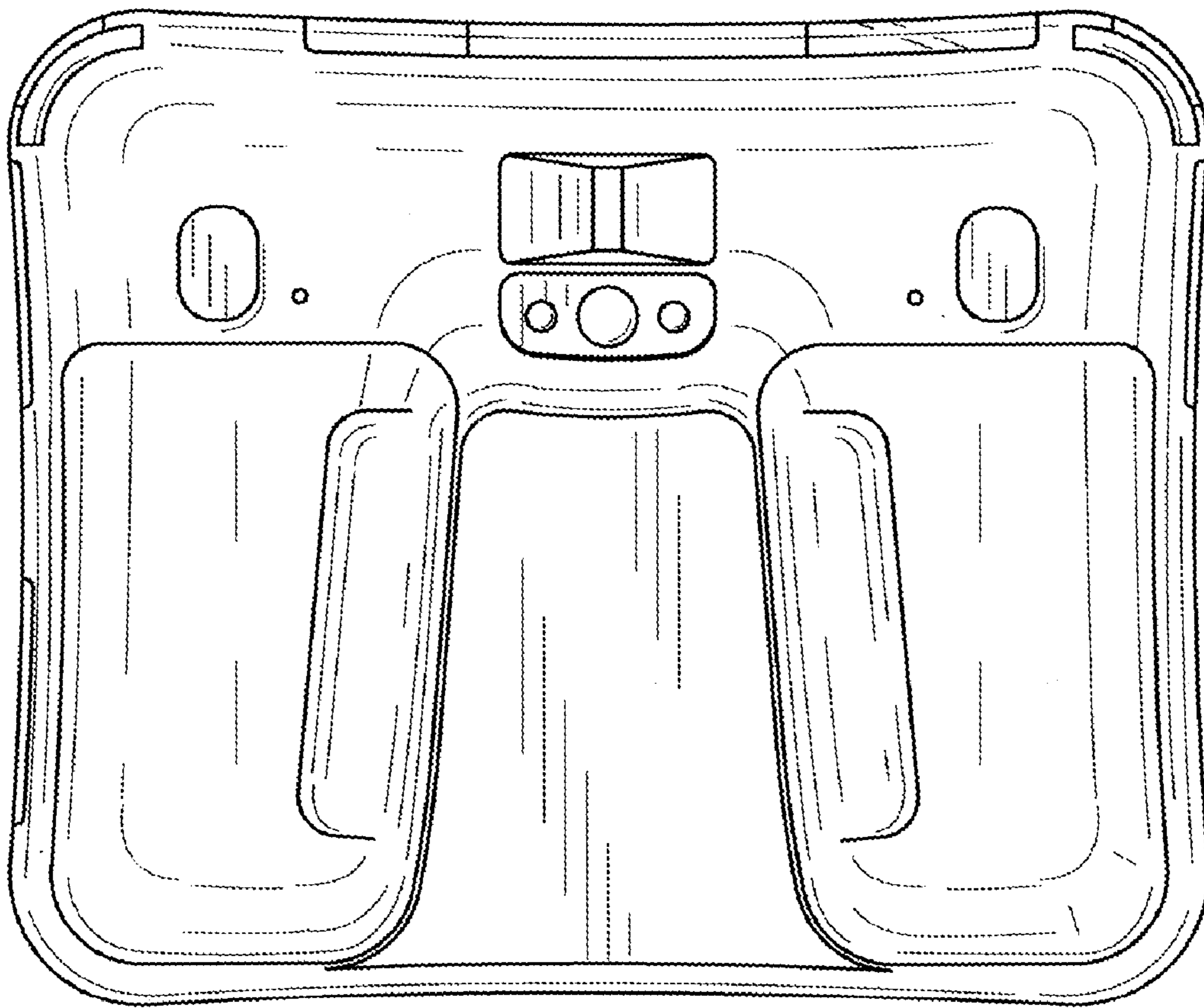

*Fig. 8.*

UNITED STATES PATENT AND TRADEMARK OFFICE  
**CERTIFICATE OF CORRECTION**

PATENT NO. : Des. 595,290 S  
APPLICATION NO. : 29/306542  
DATED : June 30, 2009  
INVENTOR(S) : H. Takemasa

Page 1 of 1

It is certified that error appears in the above-identified patent and that said Letters Patent is hereby corrected as shown below:

<u>COLUMN</u>	<u>LINE</u>	<u>ERROR</u>
(30) Pg. 1, col. 1	Foreign Application Priority Data	“Jan. 9, 2008” should read --Feb. 1, 2008--

Signed and Sealed this

First Day of June, 2010



David J. Kappos  
*Director of the United States Patent and Trademark Office*