



US00D595272S

(12) **United States Design Patent**
Kim et al.

(10) **Patent No.:** **US D595,272 S**
(45) **Date of Patent:** **** Jun. 30, 2009**

(54) **EARSET**

(75) Inventors: **Hyun-Sook Kim**, Hwaseong-si (KR);
Gee-Hong Yoon, Seongnam-si (KR)

(73) Assignee: **Samsung Electronics Co., Ltd.**,
Suwon-Si (KR)

(**) Term: **14 Years**

(21) Appl. No.: **29/322,060**

(22) Filed: **Jul. 29, 2008**

(51) **LOC (9) Cl.** **14-01**

(52) **U.S. Cl.** **D14/223**

(58) **Field of Classification Search** D14/205,
D14/206, 223, 142, 188, 192, 217, 219, 221,
D14/357; D13/154; 181/129, 130, 176;
379/430, 433.11; 381/380, 381, 191, 192;
455/569.1, 575.1, 575.8, 90.1
See application file for complete search history.

(56) **References Cited**

U.S. PATENT DOCUMENTS

D481,374 S * 10/2003 Lee D14/188
6,795,718 B2 * 9/2004 Bae 455/575.2
D555,150 S * 11/2007 Christopher et al. D14/223

D559,836 S * 1/2008 Lee D14/223
D566,103 S * 4/2008 Sade et al. D14/223
D566,692 S * 4/2008 Sade et al. D14/223
D566,694 S * 4/2008 Kim et al. D14/223
D573,983 S * 7/2008 Bang et al. D14/223
D579,925 S * 11/2008 Jaakkola et al. D14/223
D582,897 S * 12/2008 Christopher et al. D14/223

* cited by examiner

Primary Examiner—Paula Greene

(74) *Attorney, Agent, or Firm*—Staas & Halsey LLP

(57) **CLAIM**

The ornamental design for an earset, as shown and described.

DESCRIPTION

FIG. 1 is a perspective view of an earset according to our new design;

FIG. 2 is a front elevational view thereof;

FIG. 3 is a rear elevational view thereof;

FIG. 4 is a left side elevational view thereof;

FIG. 5 is a right side elevational view thereof;

FIG. 6 is a top plan view thereof; and,

FIG. 7 is a bottom plan view thereof.

1 Claim, 7 Drawing Sheets

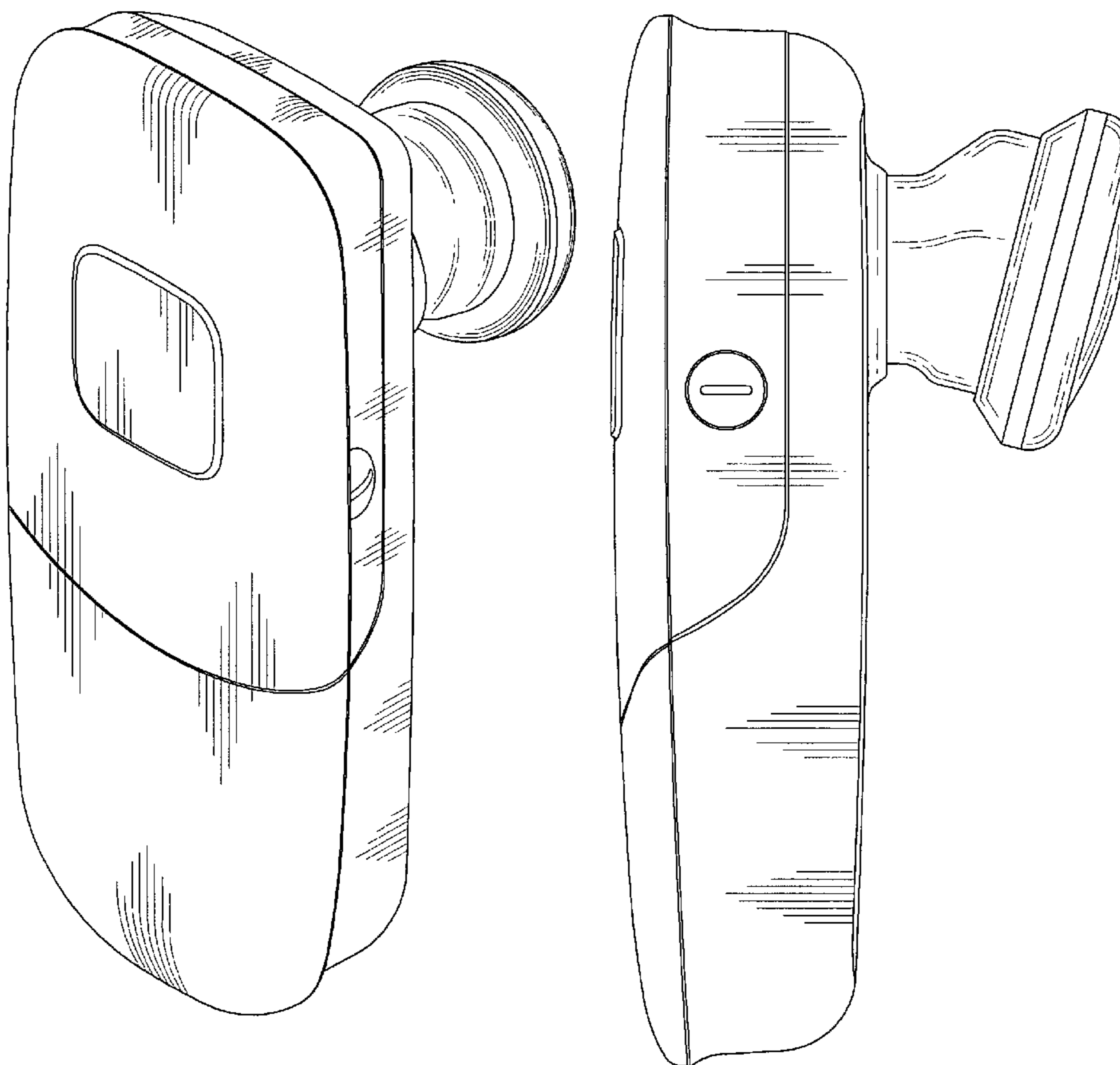

FIG. 1

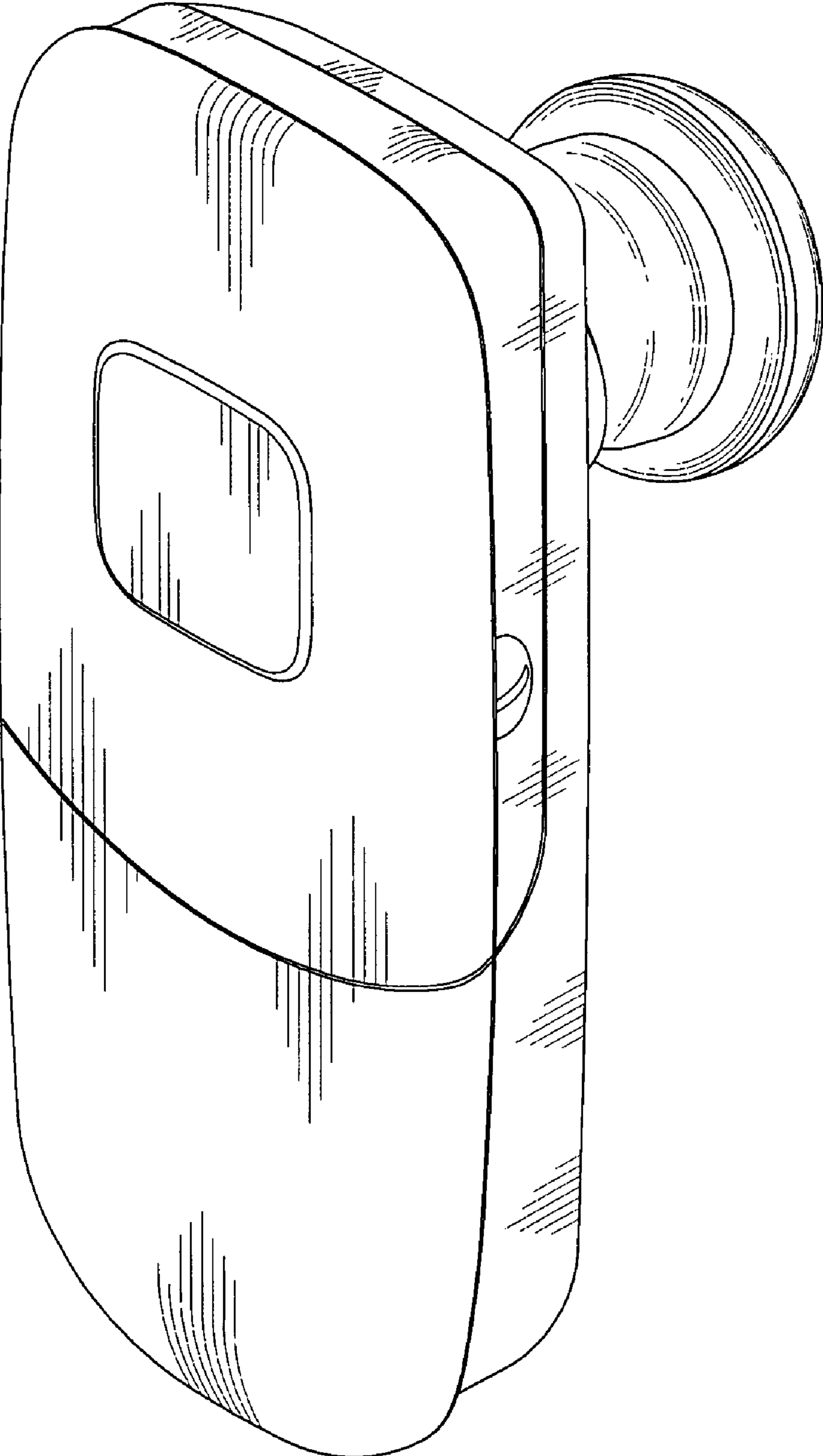

FIG.2

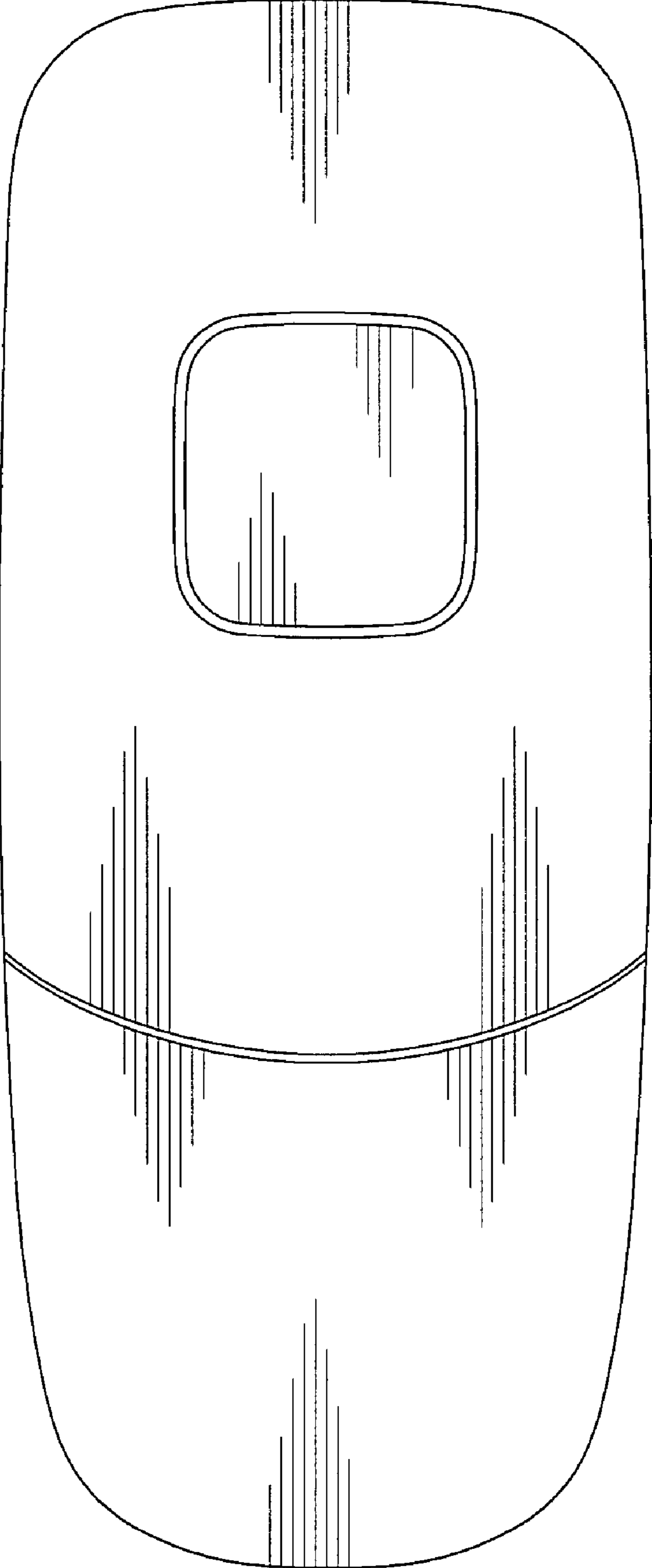

FIG.3

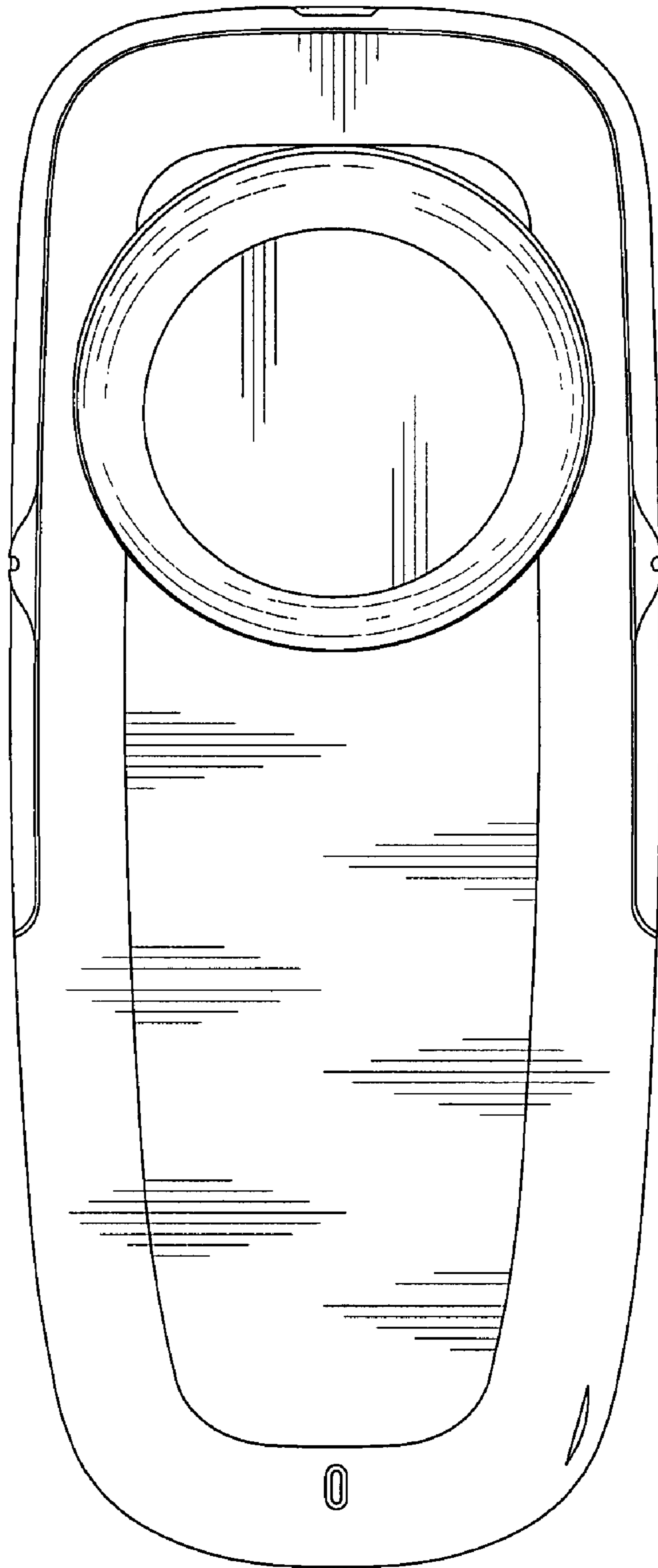

FIG.4

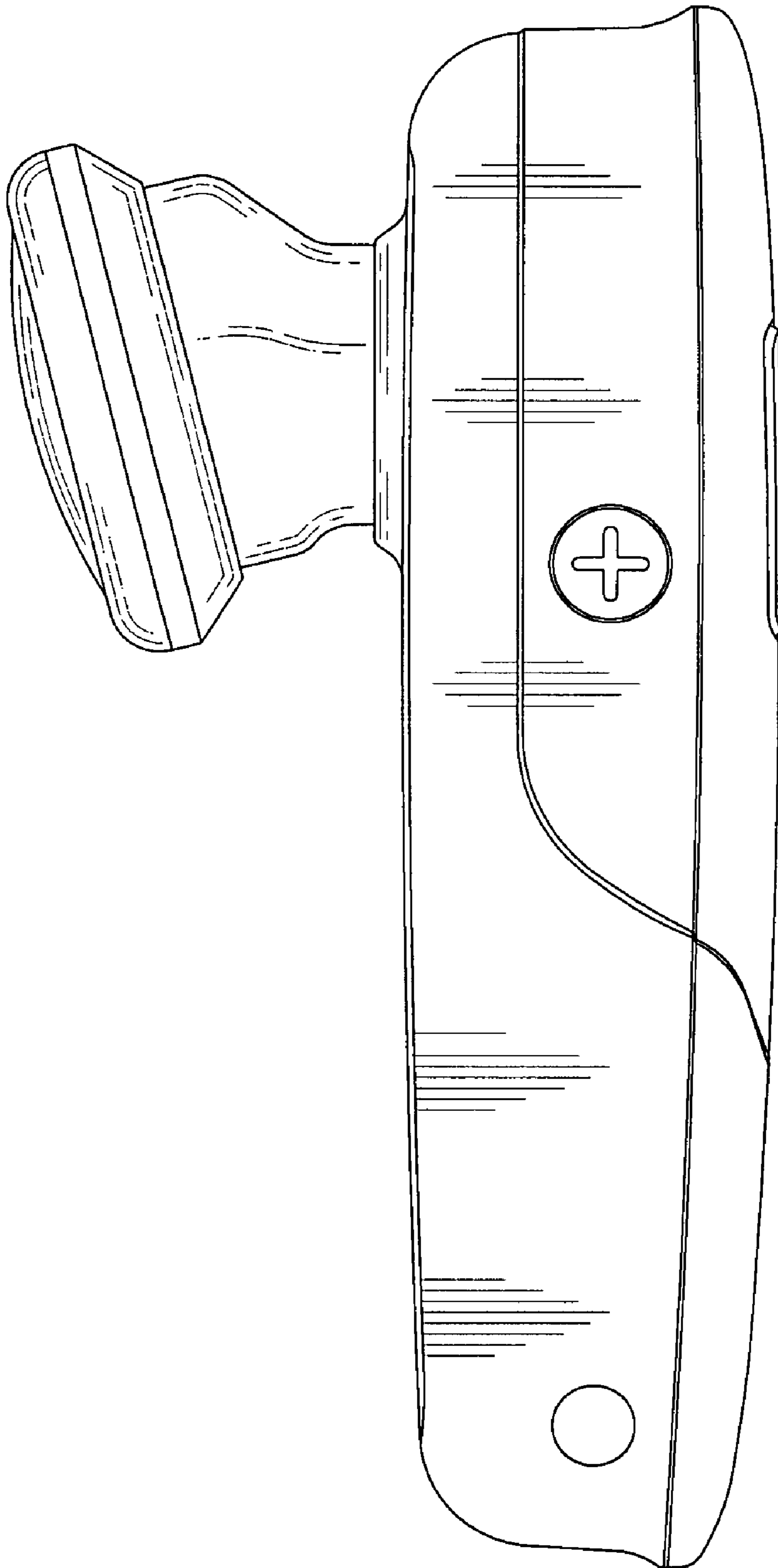

FIG.5

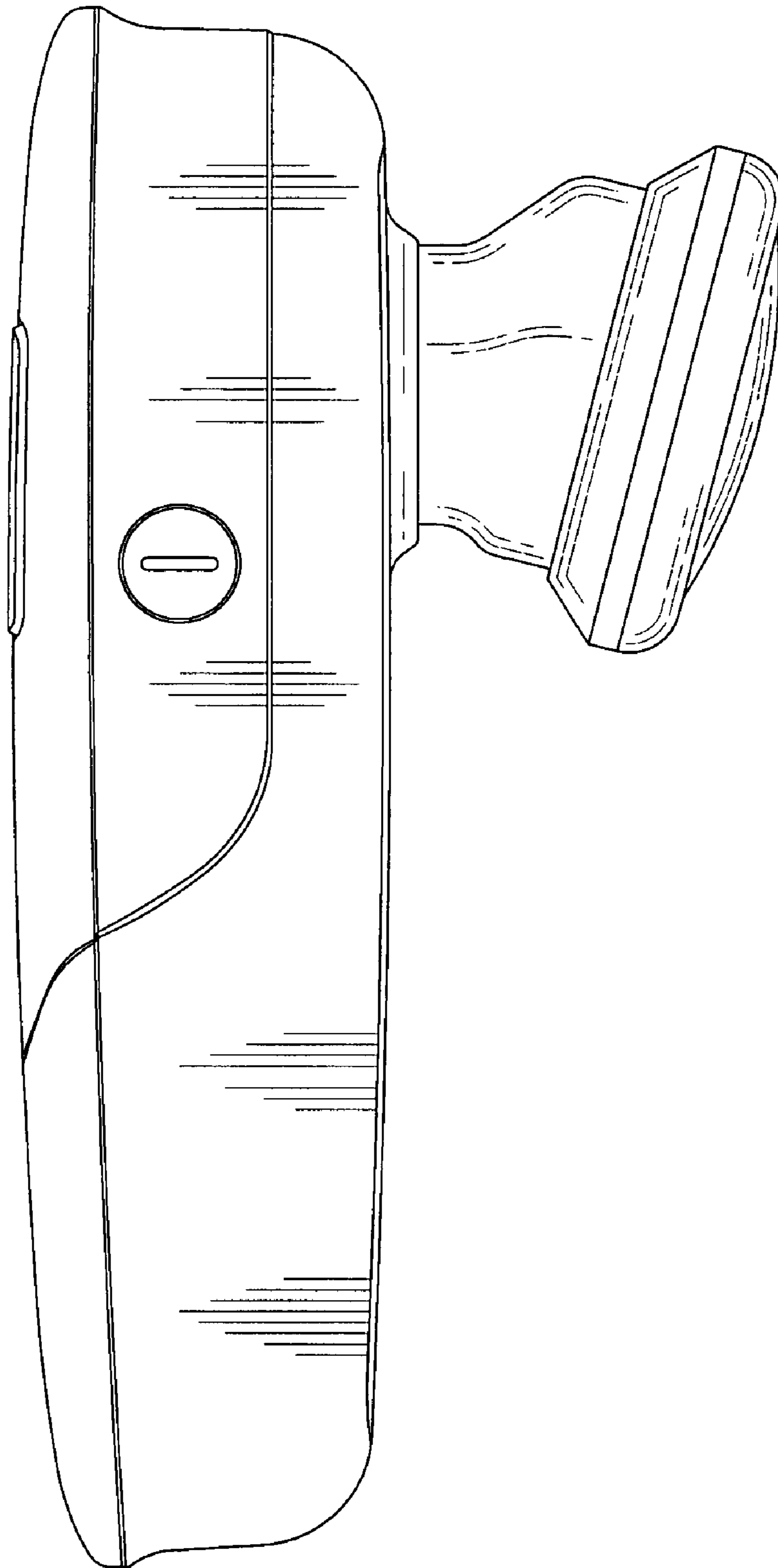

FIG.6

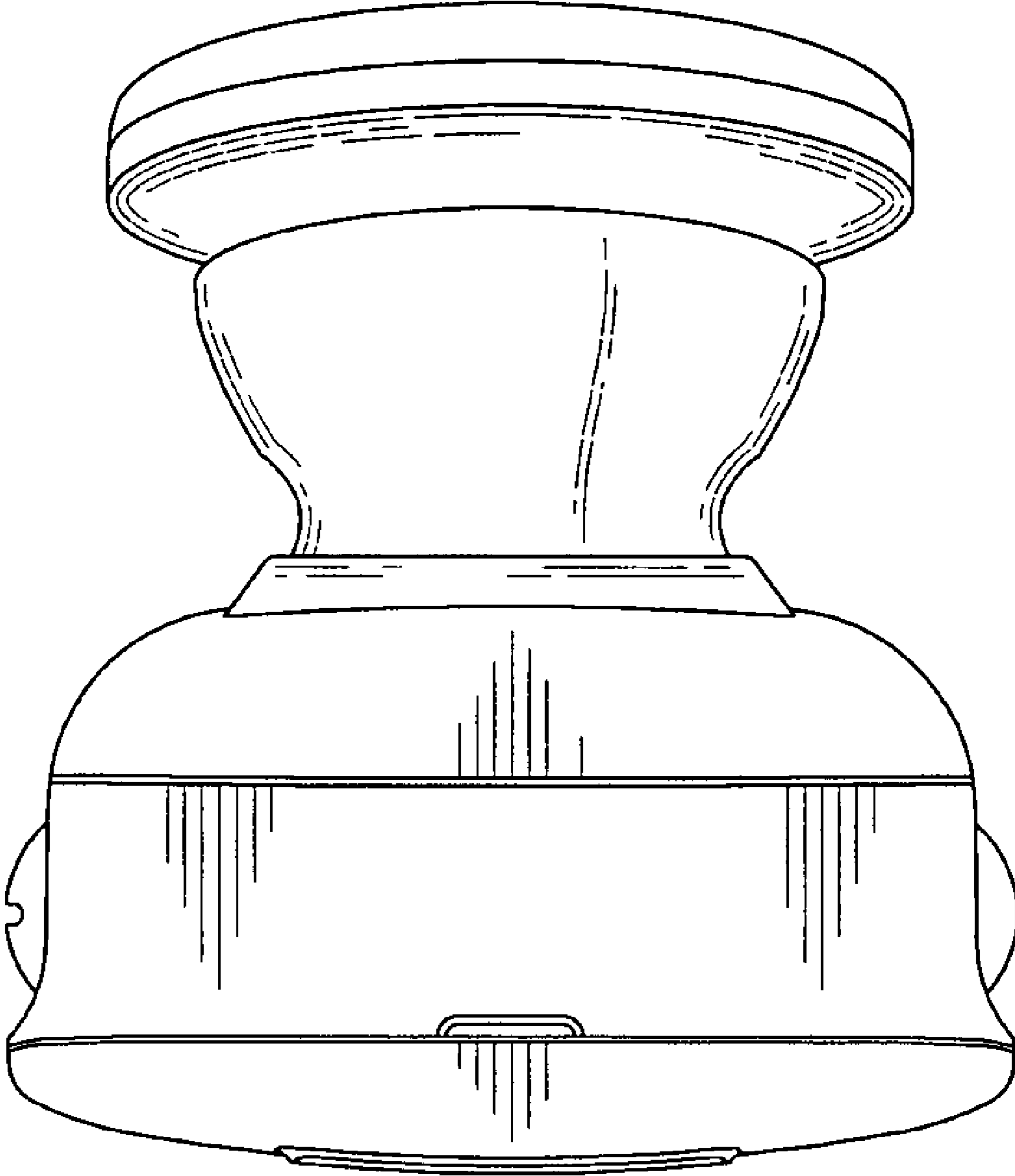

FIG. 7

