



US00D595261S

(12) **United States Design Patent**
Xie et al.

(10) **Patent No.:** **US D595,261 S**
(45) **Date of Patent:** **** Jun. 30, 2009**

(54) **MULTIMEDIA SPEAKER**

(57) **CLAIM**

(75) Inventors: **Xiaoguang Xie**, Beijing (CN); **Shuangyi Yin**, Beijing (CN)

The ornamental design for a multimedia speaker, as shown and described.

(73) Assignee: **Beijing Edifier Technology Co. Ltd.**, Beijing (CN)

DESCRIPTION

(**) Term: **14 Years**

FIG. 1 is a front view of the central component of the multimedia speaker of the present design, shown separately for clarity of illustration;

(21) Appl. No.: **29/299,568**

FIG. 2 is a rear view thereof;

(22) Filed: **Dec. 28, 2007**

FIG. 3 is a left side view thereof;

(51) **LOC (9) Cl.** **14-01**

FIG. 4 is a right side view thereof;

(52) **U.S. Cl.** **D14/168; D14/172; D14/204**

FIG. 5 is a top plan view thereof;

(58) **Field of Classification Search** **D14/204, D14/209-217, 170-172, 496, 168, 194, 198, D14/500-505; 181/143-144, 147-148, 150, 181/157, 198-199, 151, 153; 381/300-302, 381/306, 333, 345, 361-364, 386-388, 332, 381/336; 320/107, 114**

FIG. 6 is a bottom plan view thereof;

FIG. 7 is a front view of one of the speaker components of the multimedia speaker, shown separately for clarity of illustration;

See application file for complete search history.

FIG. 8 is a rear view of FIG. 7;

FIG. 9 is a left side view of FIG. 7;

FIG. 10 is a right side view of FIG. 7;

FIG. 11 is a top plan view of FIG. 7;

FIG. 12 is a bottom plan view of FIG. 7; and,

FIG. 13 is a perspective view of the multimedia speaker.

The second speaker of the multimedia speaker is identical to the first speaker.

The broken line showing on the drawing disclosure is for illustrative purposes only and forms no part of the claimed design.

(56) **References Cited**

U.S. PATENT DOCUMENTS

D429,237 S *	8/2000	Cho	D14/214
D477,829 S *	7/2003	Hussaini et al.	D14/496
D509,223 S *	9/2005	Steele et al.	D14/168
D540,781 S *	4/2007	Patel et al.	D14/214

* cited by examiner

Primary Examiner—Nanda Bondade

(74) *Attorney, Agent, or Firm*—Miles & Stockbridge P.C.

1 Claim, 10 Drawing Sheets

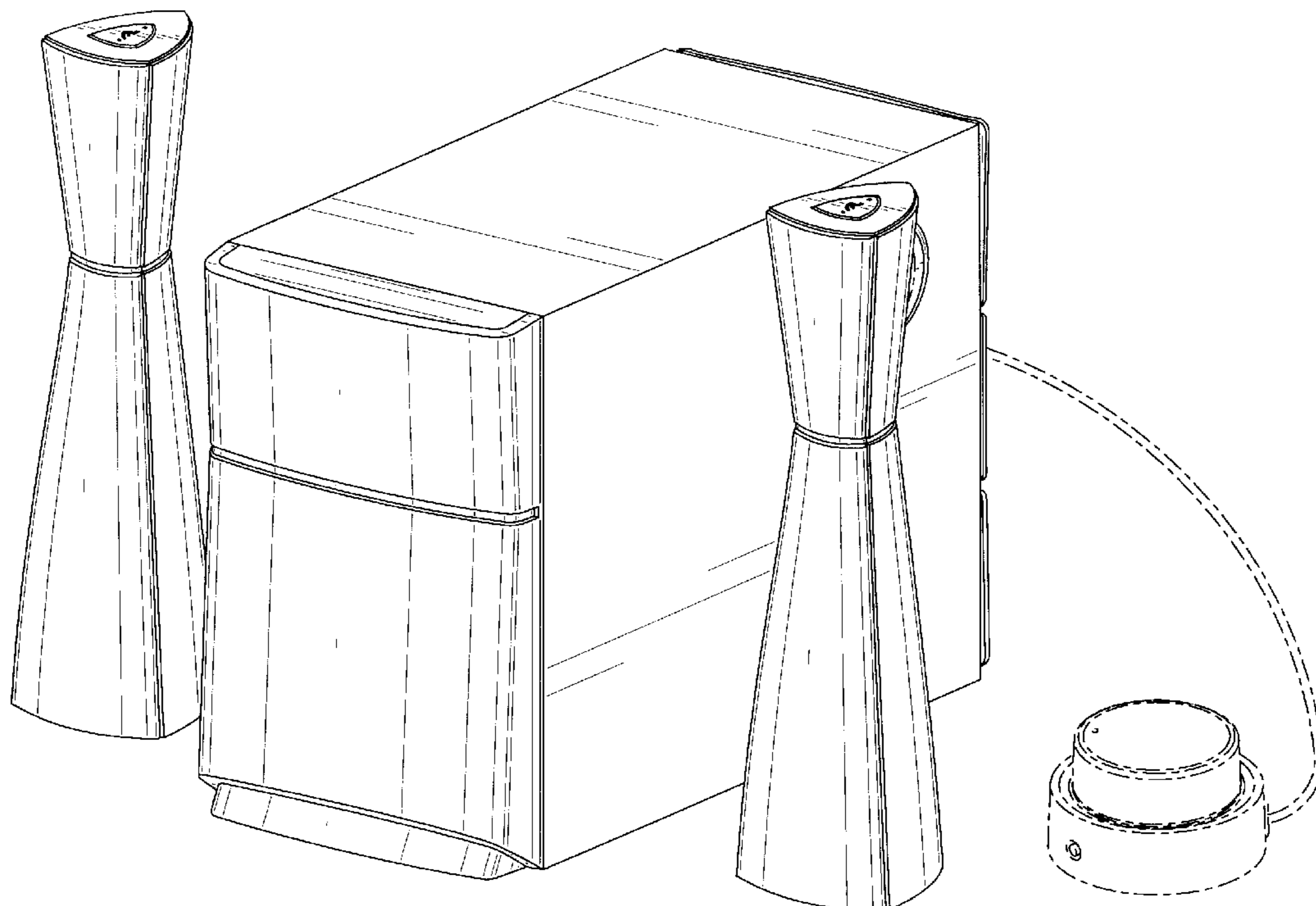

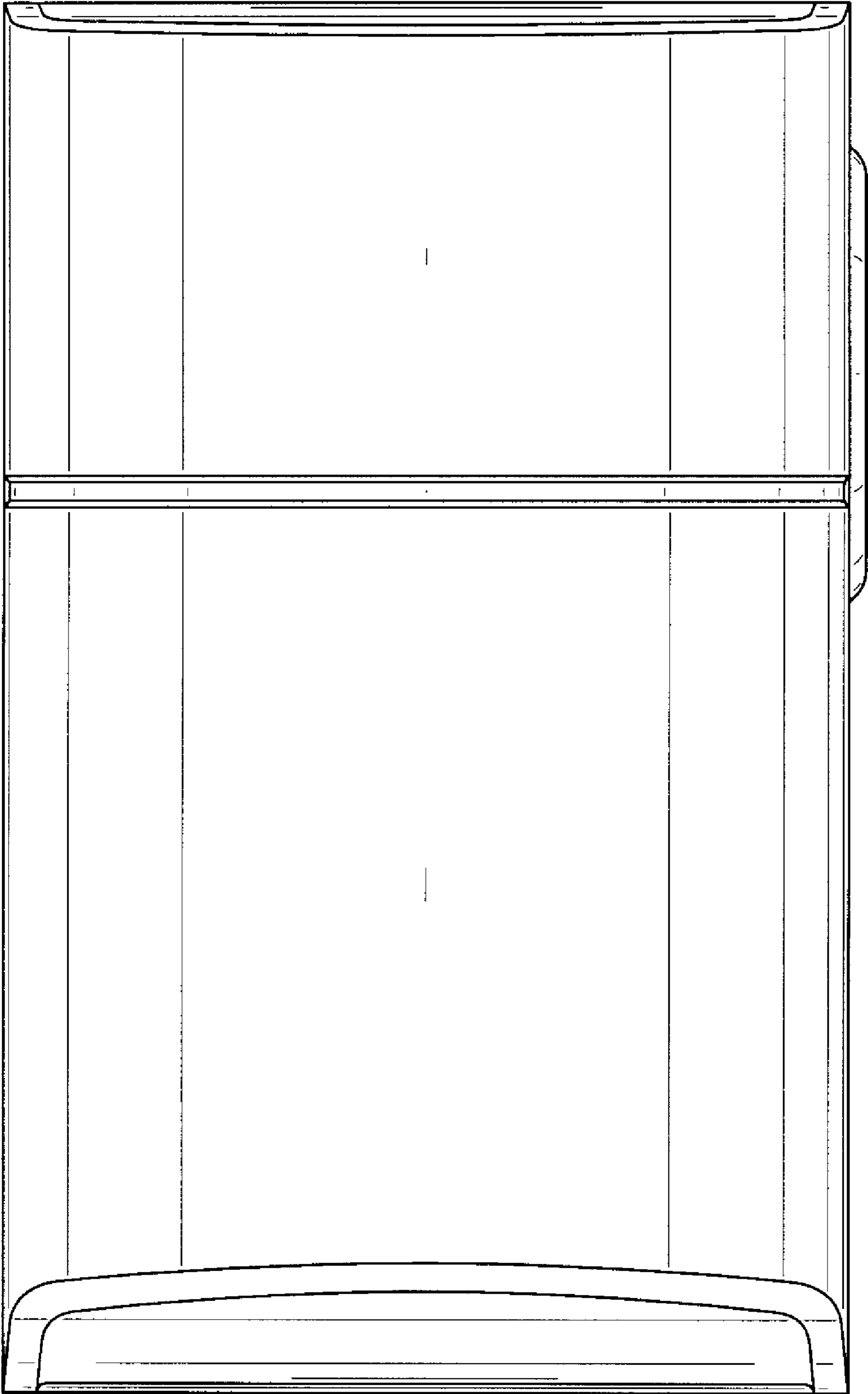

FIG. 1

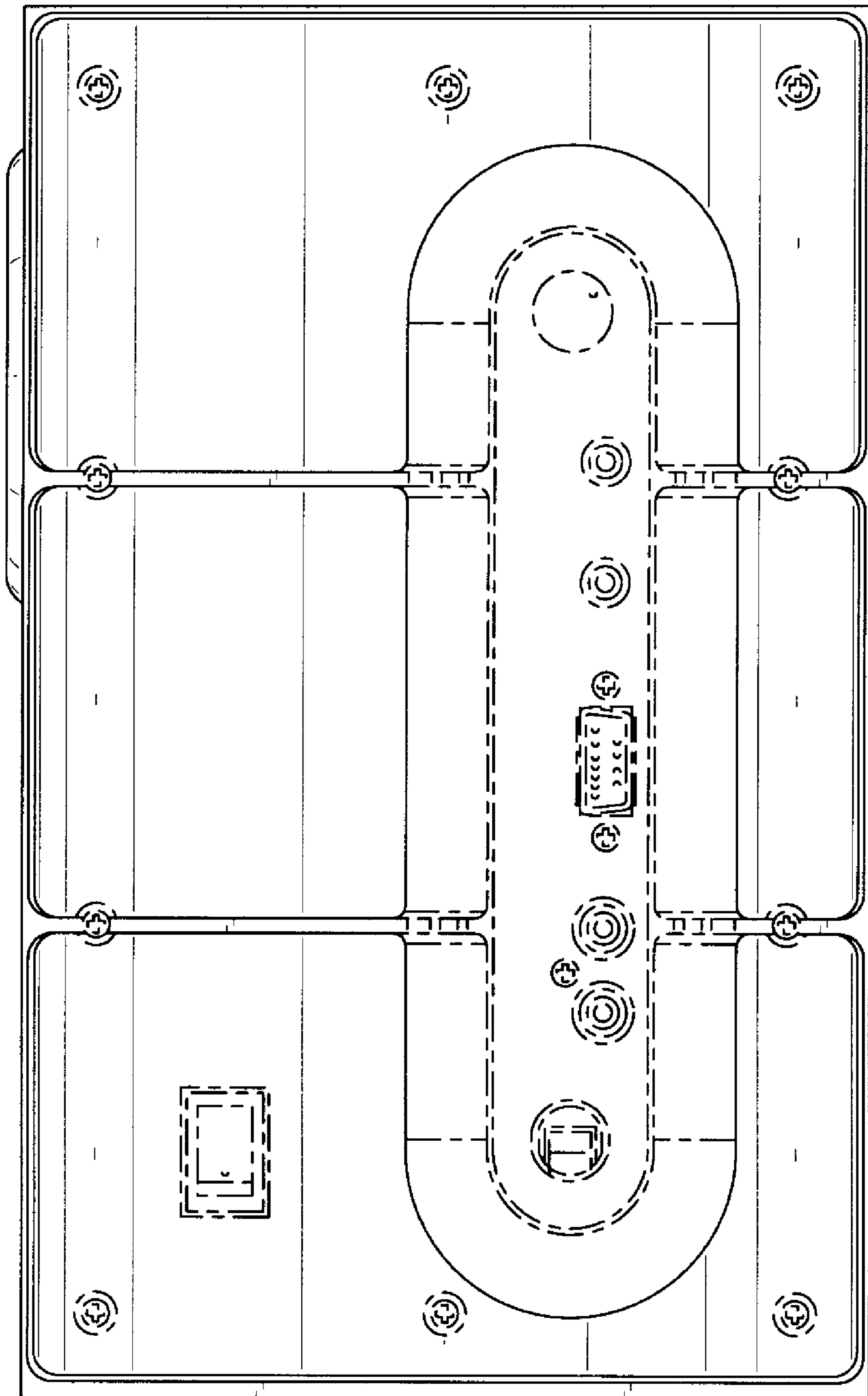

FIG. 2

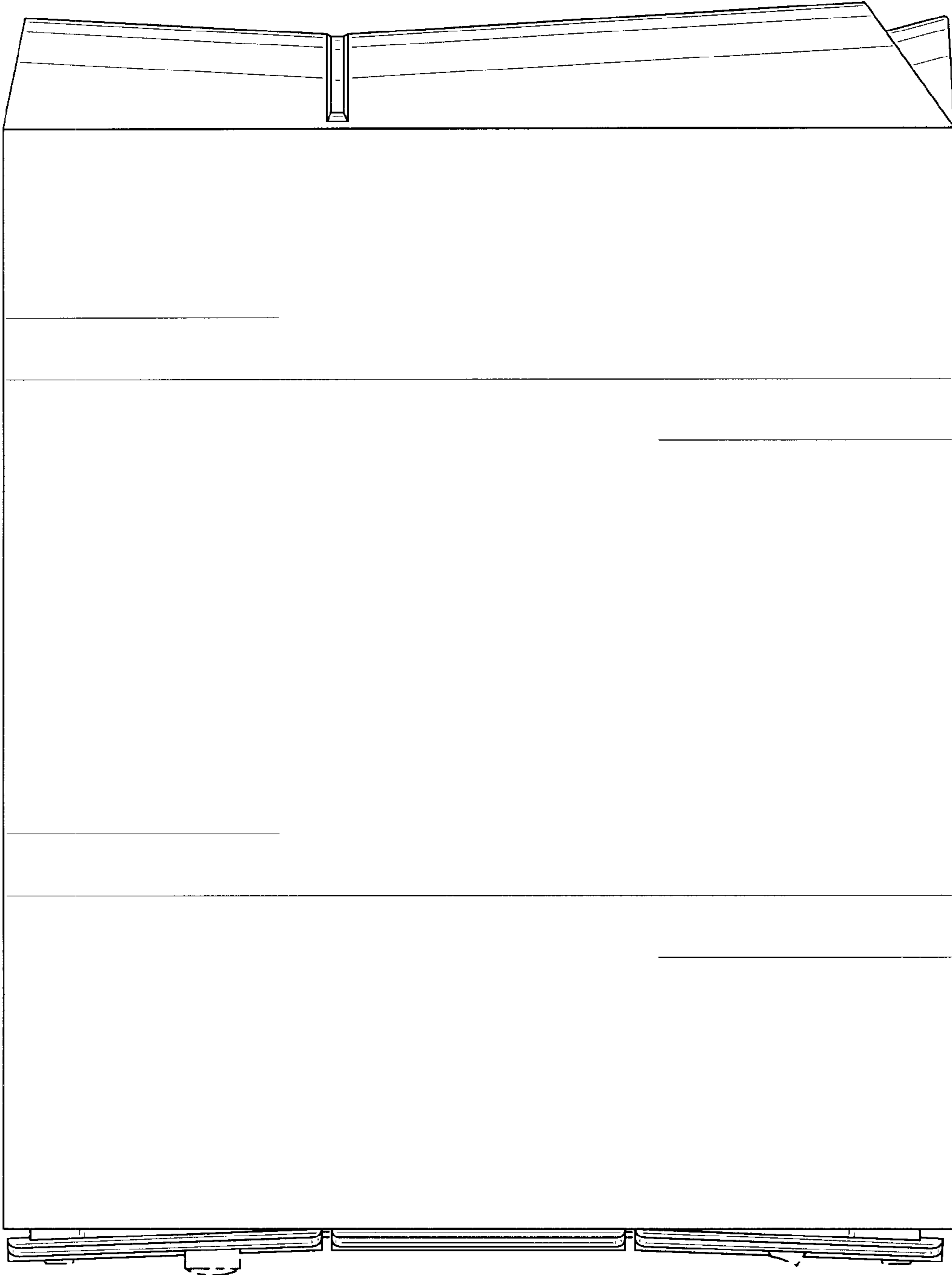

FIG. 3

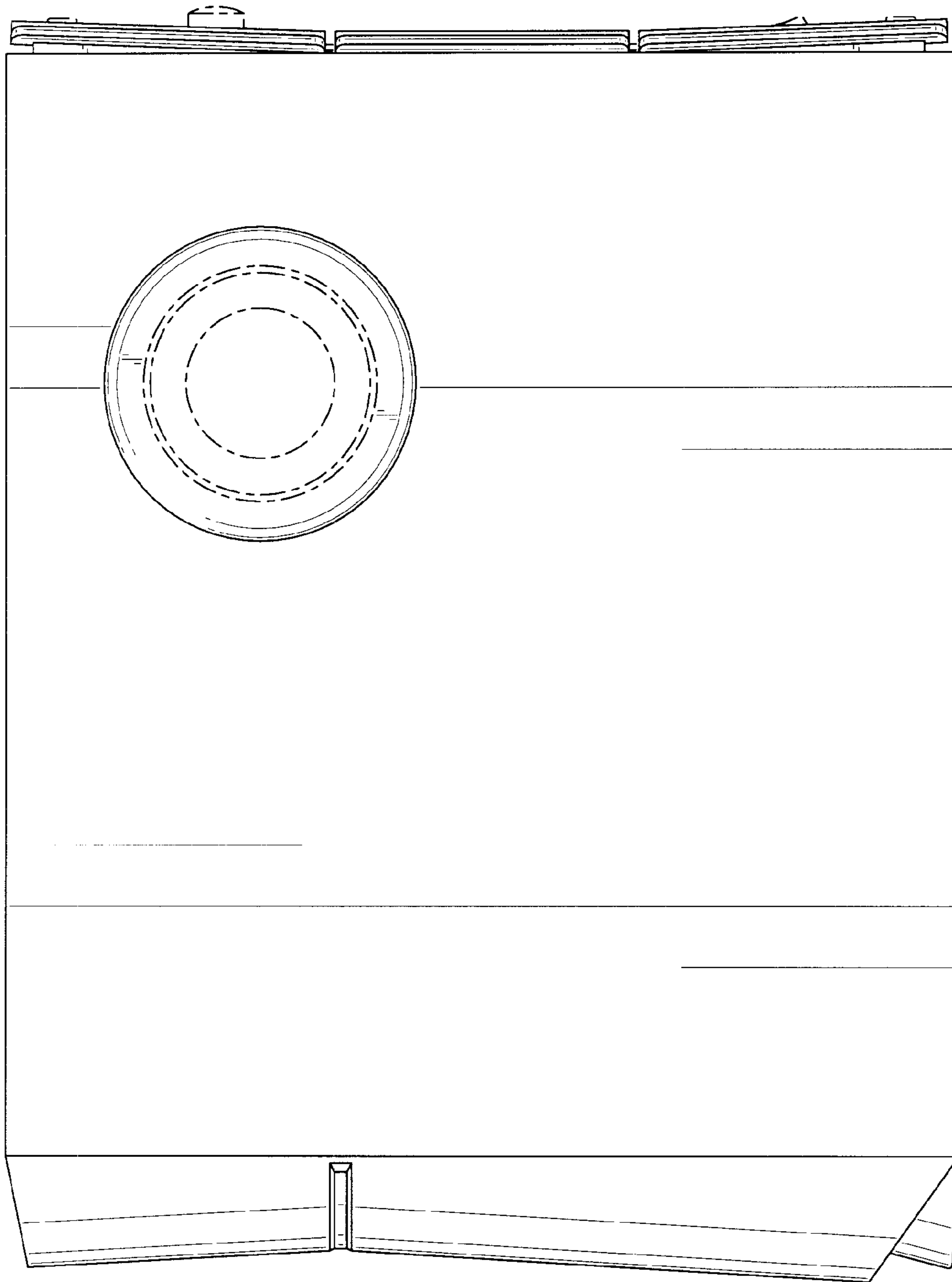

FIG. 4

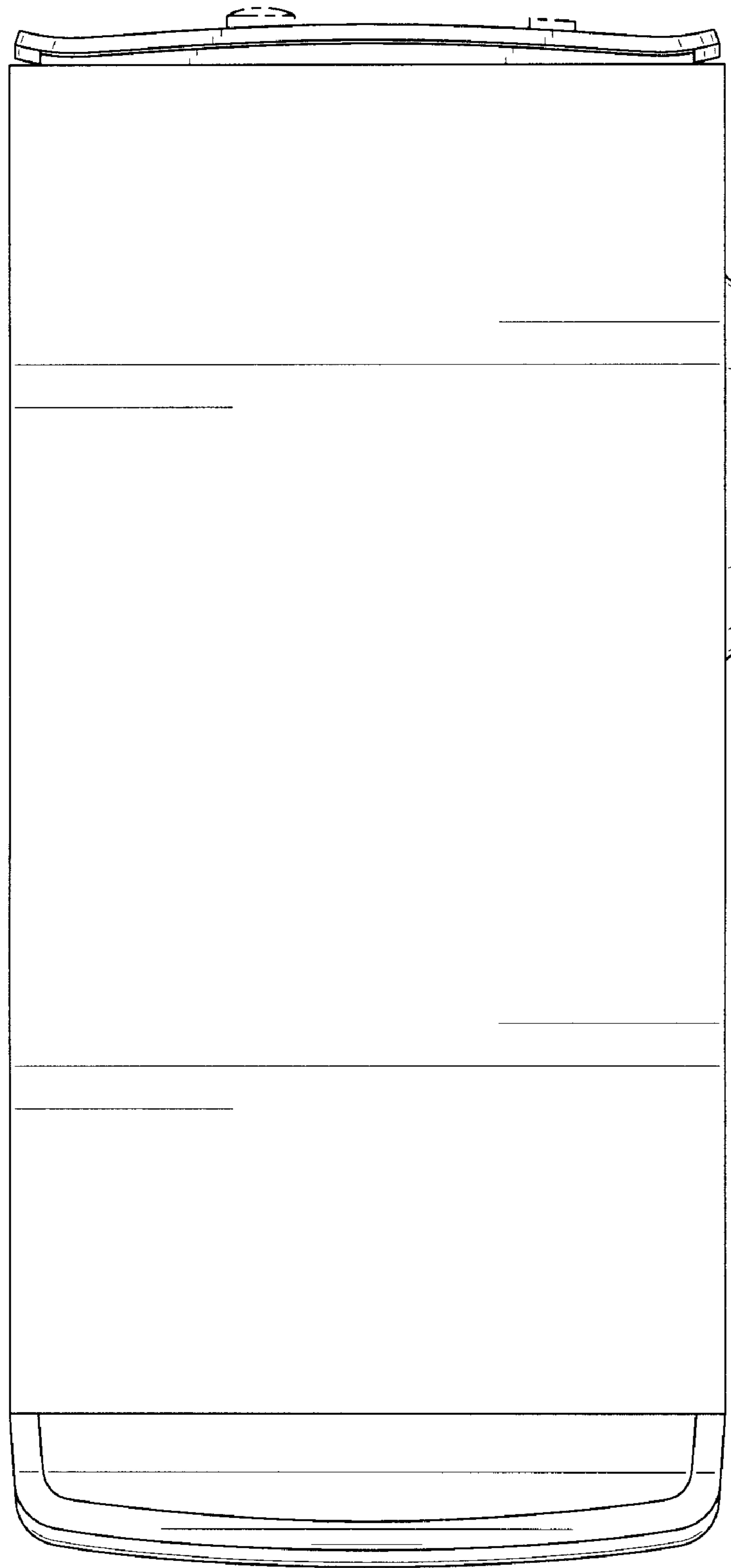

FIG. 5

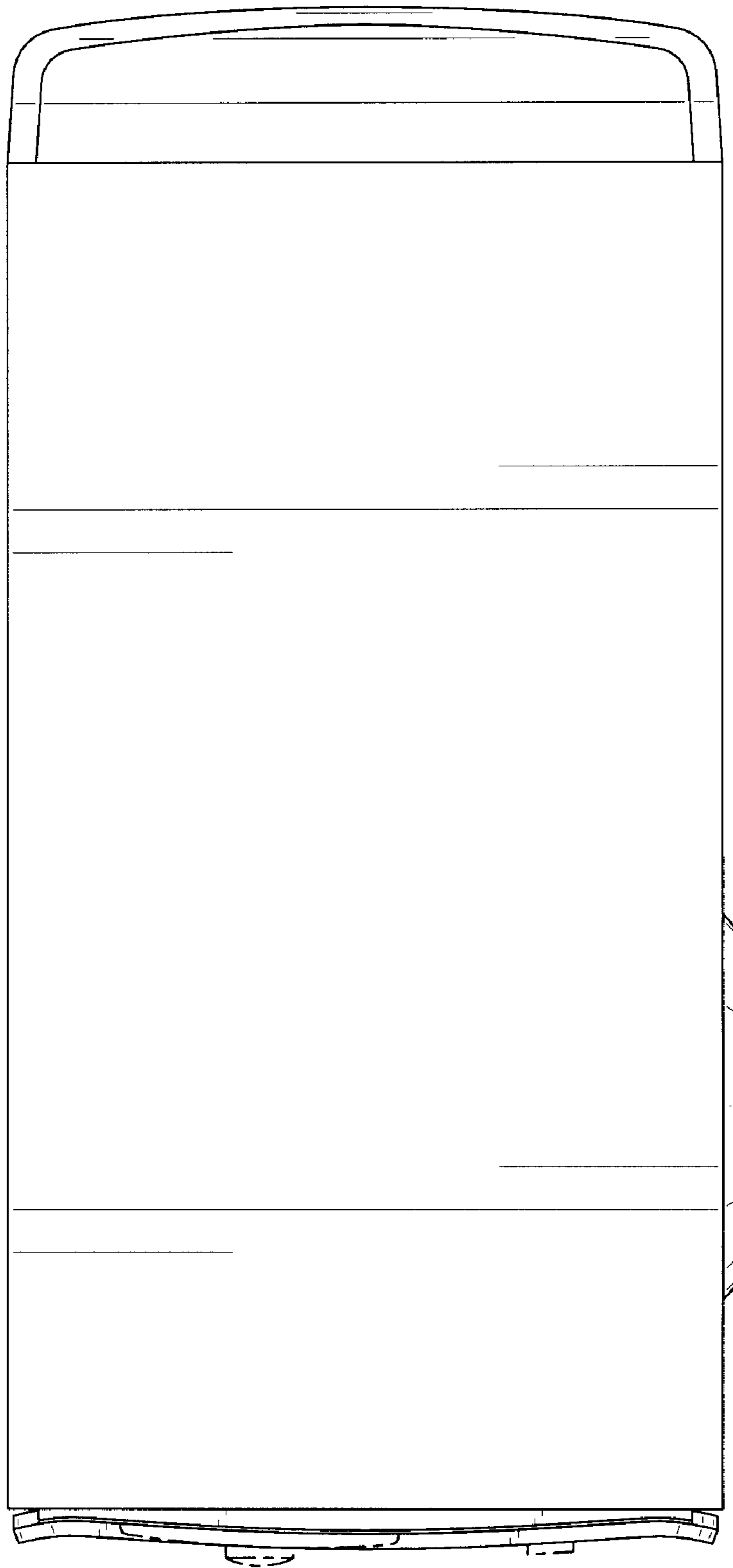

FIG. 6

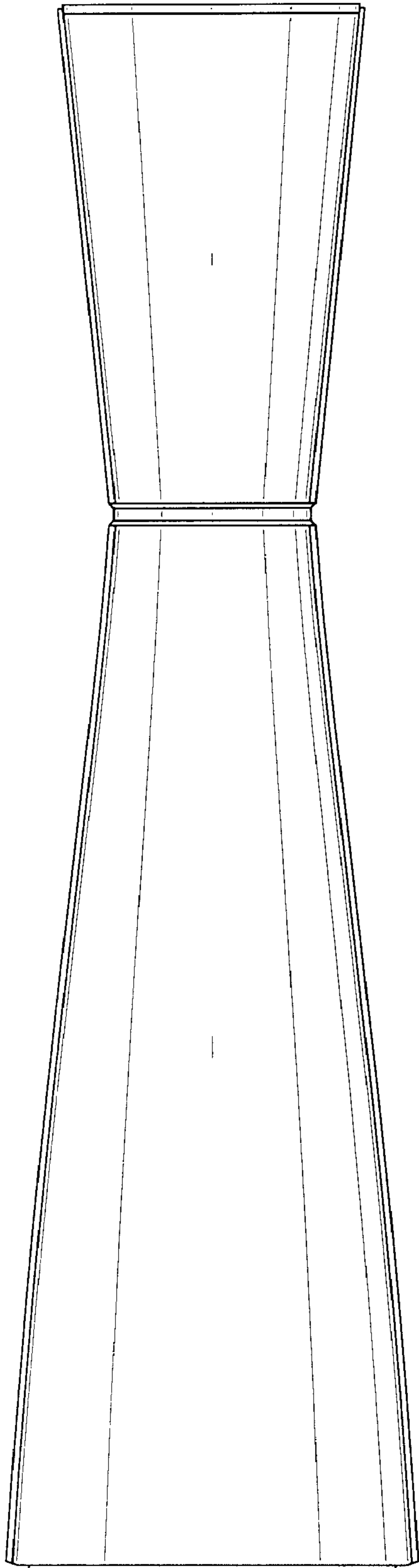

FIG. 7

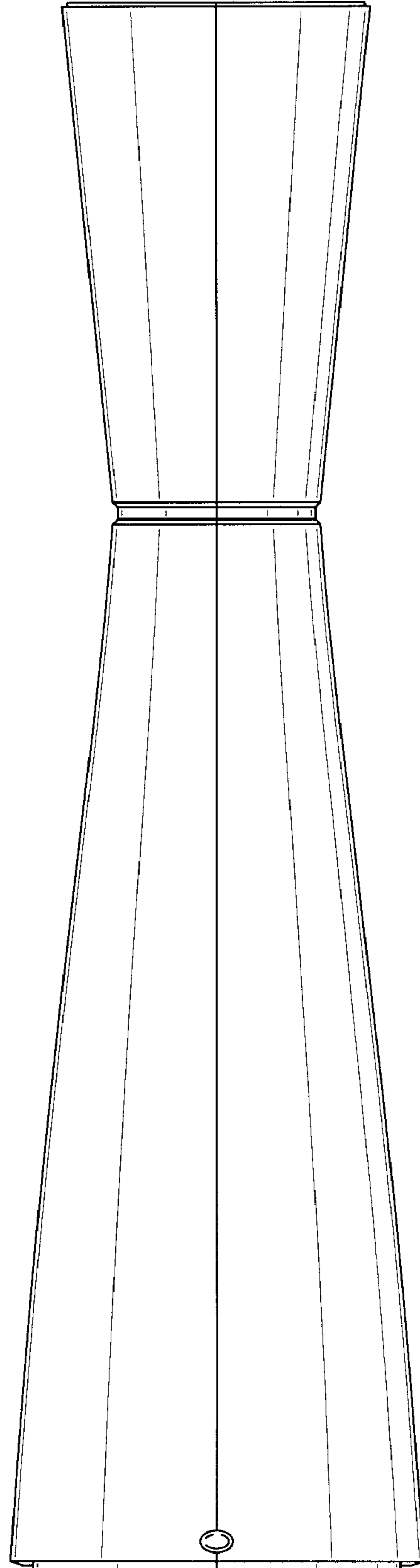

FIG. 8

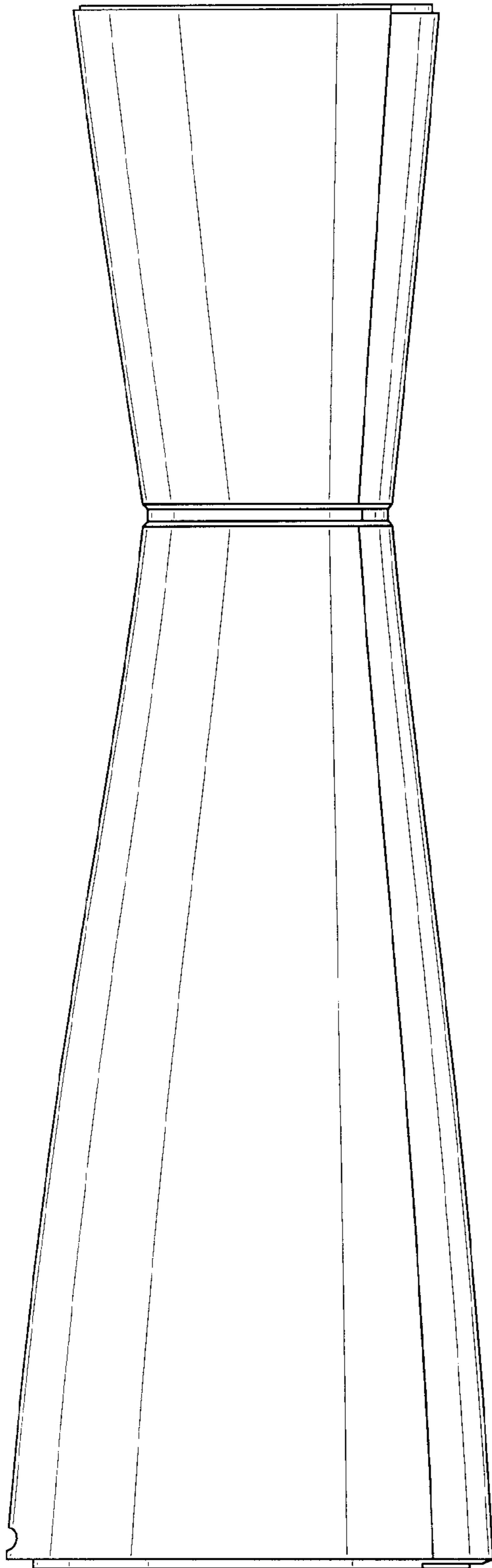

FIG. 9

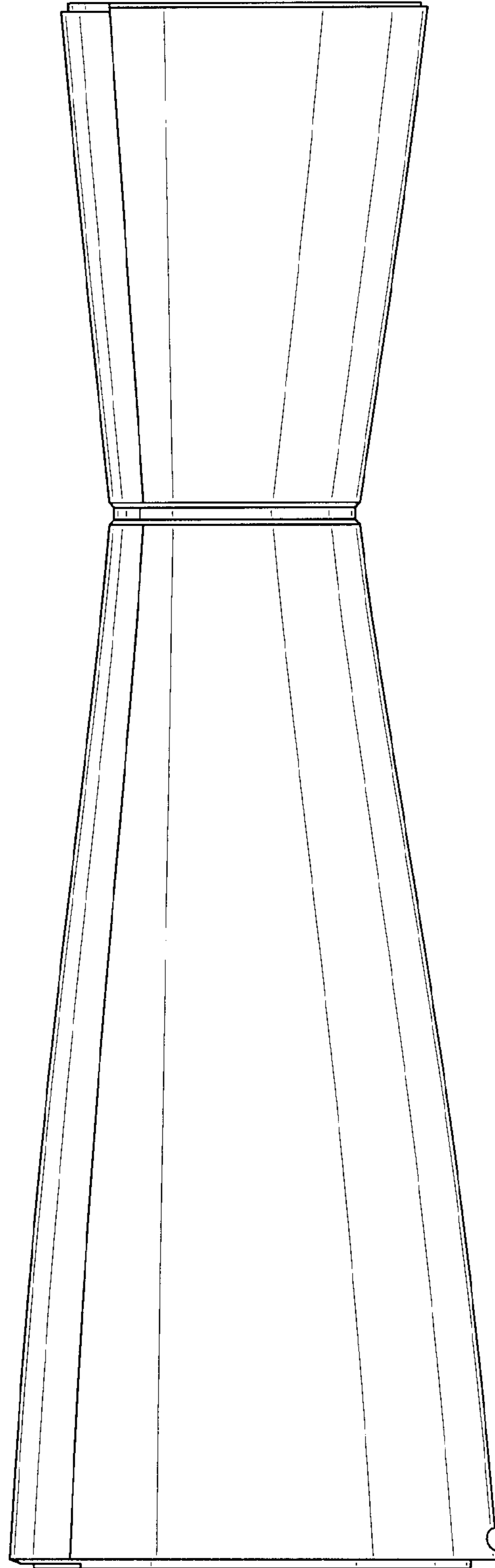

FIG. 10

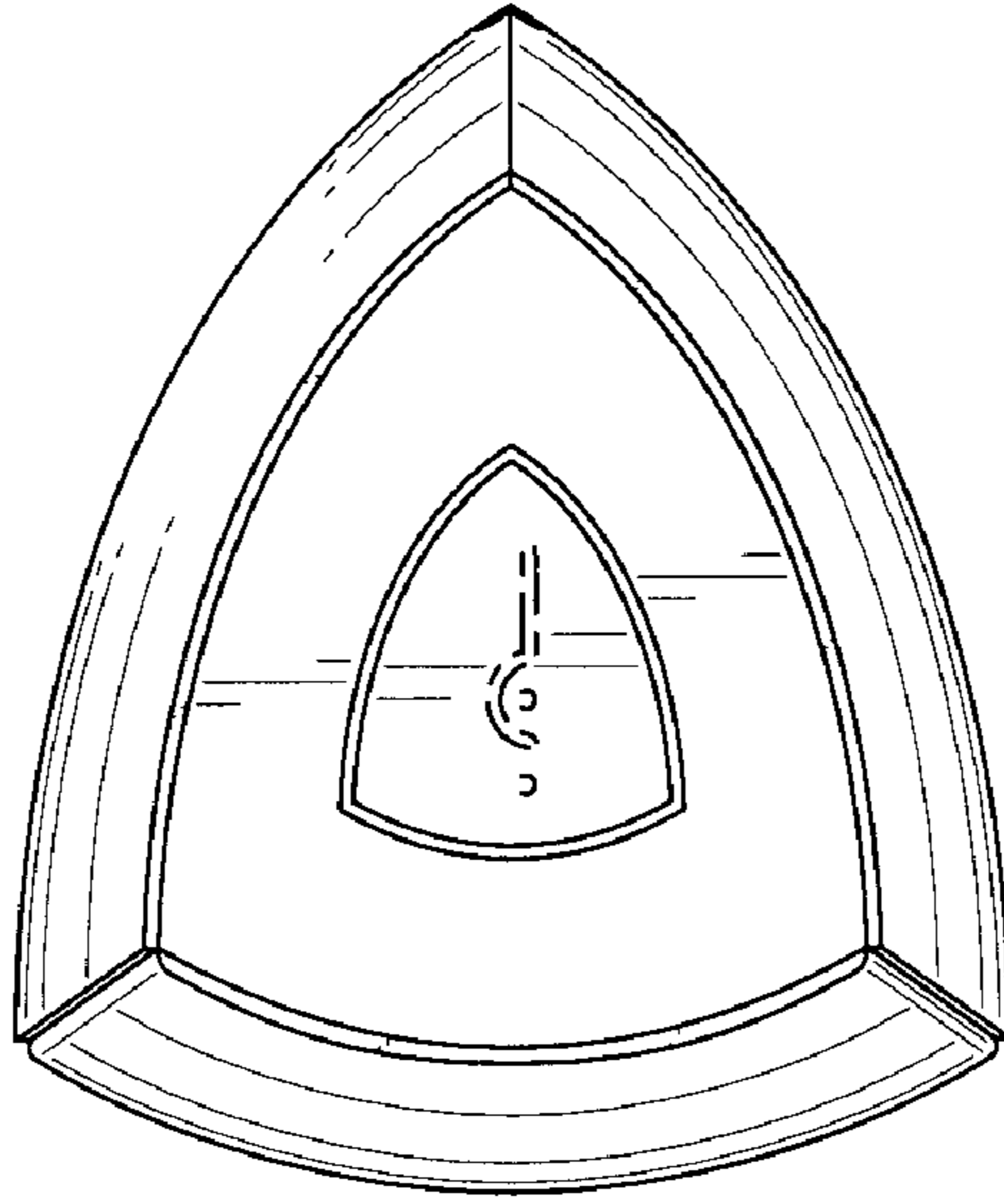

FIG. 11

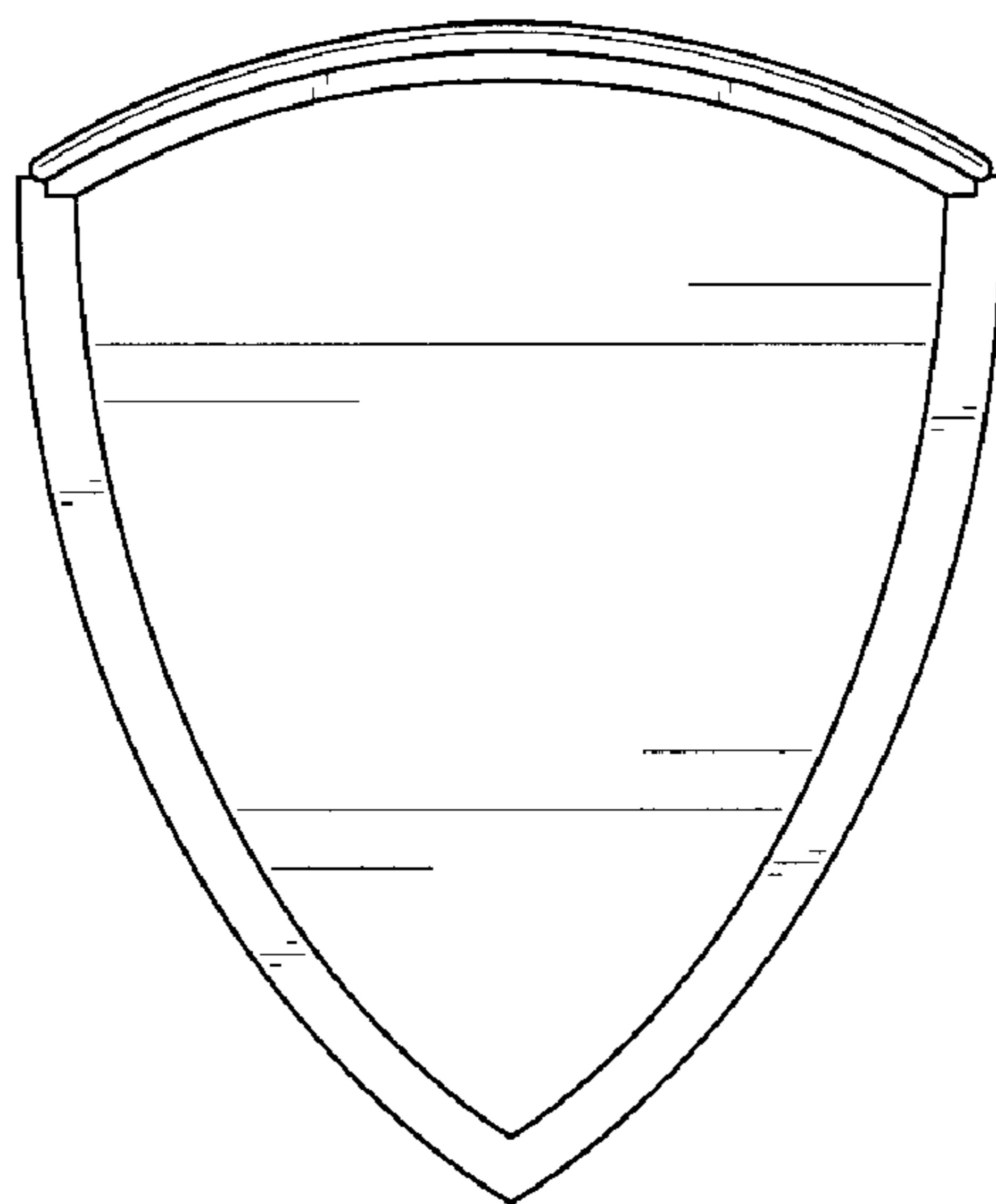

FIG. 12

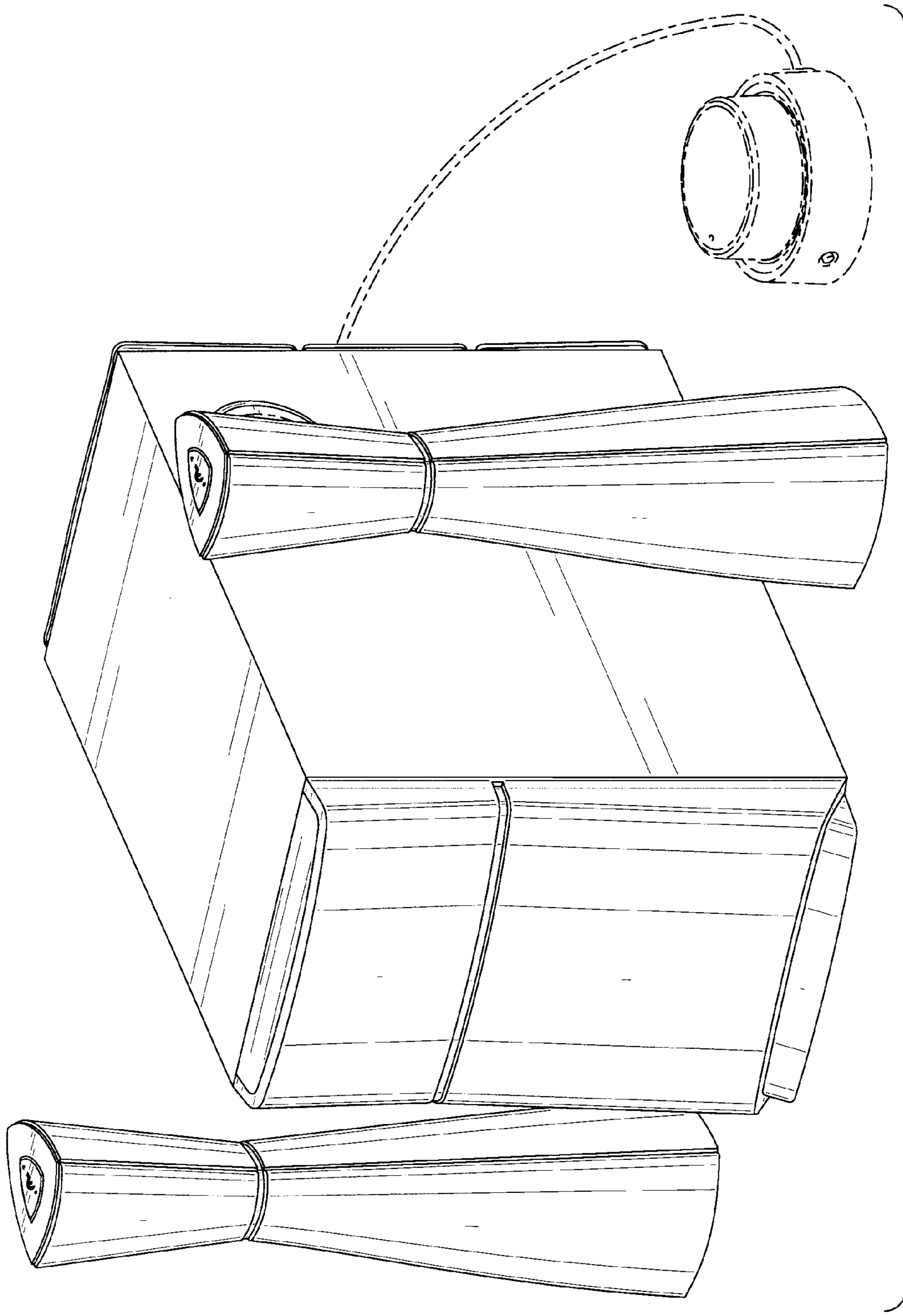

FIG. 13