

US00D595198S

(12) **United States Design Patent**
Woodard, Jr. et al.

(10) **Patent No.:** **US D595,198 S**
(45) **Date of Patent:** **** Jun. 30, 2009**

(54) **VEHICLE DASHBOARD**

(75) Inventors: **Roy Linwood Woodard, Jr.**, Statesboro, GA (US); **Bruce Rice Crapse**, Aiken, SC (US); **Dean Jayson Long**, Bradenton, FL (US)

(73) Assignee: **Club Car, Inc.**, Evans, GA (US)

(**) Term: **14 Years**

(21) Appl. No.: **29/332,252**

(22) Filed: **Feb. 11, 2009**

Related U.S. Application Data

(63) Continuation of application No. 29/321,568, filed on Jul. 18, 2008, now Pat. No. Des. 586,714.

(51) **LOC (9) Cl.** **12-16**

(52) **U.S. Cl.** **D12/192**

(58) **Field of Classification Search** D12/192, D12/415; 180/190; 280/750-752; 296/190.01-190.09, 296/70; D15/17, 28; D10/46, 98, 102-103
See application file for complete search history.

(56) **References Cited**

U.S. PATENT DOCUMENTS

D339,786 S *	9/1993	Allendorph et al.	D12/192
D403,641 S *	1/1999	Sacco et al.	D12/192
D436,069 S *	1/2001	O'Connell	D12/192
D470,091 S *	2/2003	Kraus et al.	D12/192
D489,660 S *	5/2004	Okumura et al.	D12/192

D494,115 S *	8/2004	McPeck et al.	D12/192
D512,357 S *	12/2005	Schuttera	D12/192
D514,995 S *	2/2006	Acton et al.	D12/192
D525,409 S *	7/2006	Cantrill et al.	D12/192
D532,353 S *	11/2006	Honda et al.	D12/192
D538,721 S *	3/2007	Woodard et al.	D12/192
D567,727 S *	4/2008	Kawaguchi et al.	D12/192
D571,272 S *	6/2008	Esaki et al.	D12/192
D577,640 S *	9/2008	Wyszogrod et al.	D12/192
D586,714 S *	2/2009	Woodard et al.	D12/192

* cited by examiner

Primary Examiner—Stacia Cadmus

(74) *Attorney, Agent, or Firm*—Michael Best & Friedrich LLP

(57) **CLAIM**

We claim the ornamental design for a vehicle dashboard, as shown and described.

DESCRIPTION

FIG. 1 is a perspective view of a vehicle dashboard showing our new design;

FIG. 2 is a front view thereof;

FIG. 3 is a right view thereof;

FIG. 4 is a left view thereof; and,

FIG. 5 is a top view thereof.

In the drawings, the broken lines defining portions of the dashboard depict environmental subject matter that forms no part of the claimed design.

1 Claim, 4 Drawing Sheets

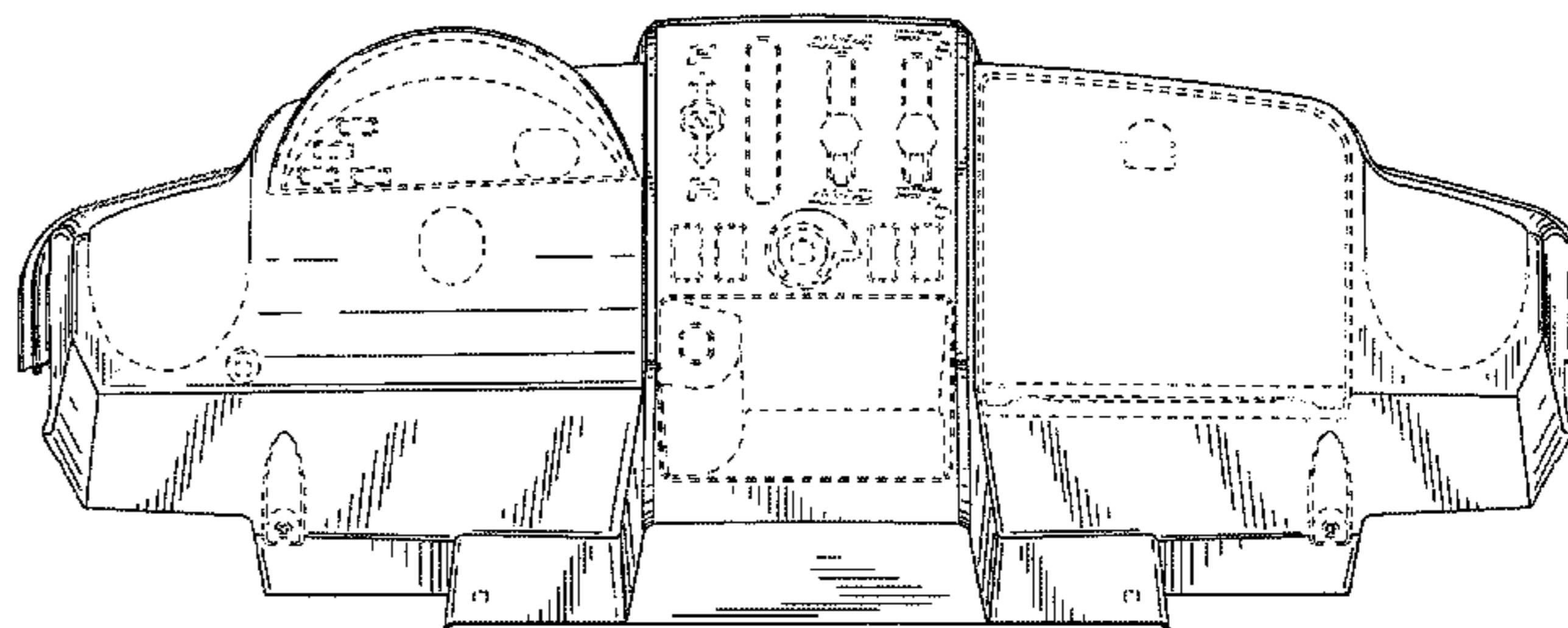
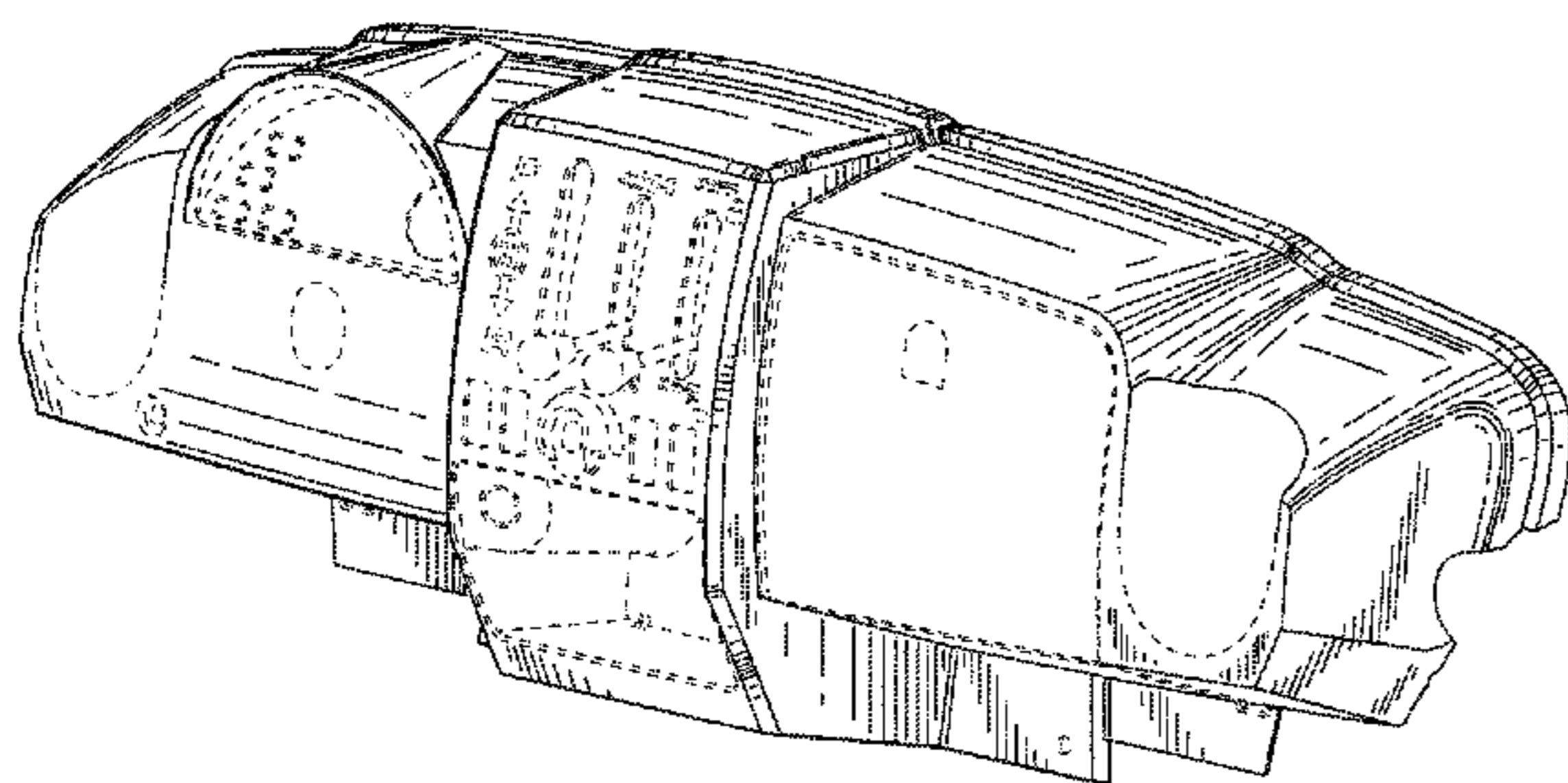

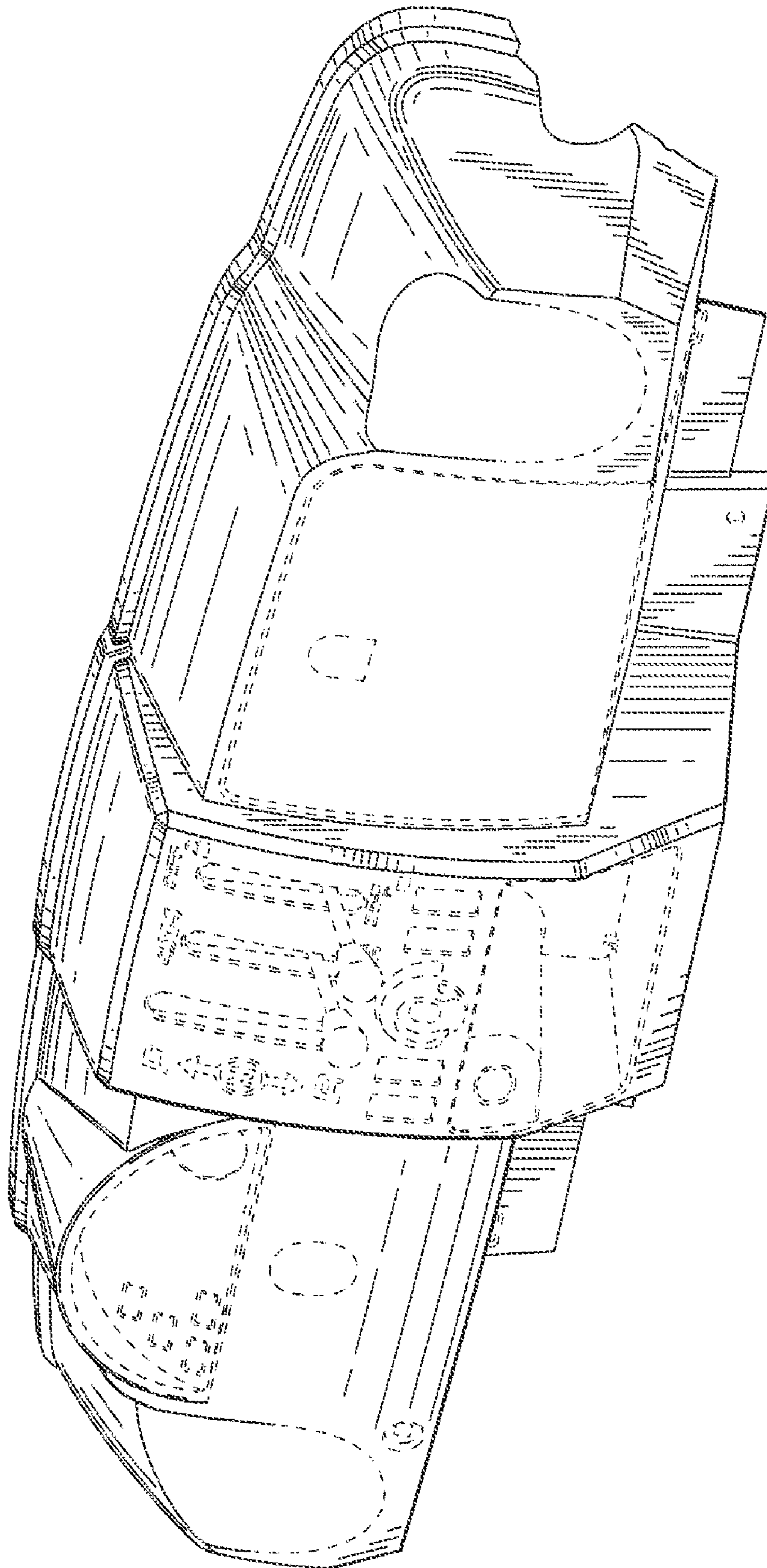

FIG. 1

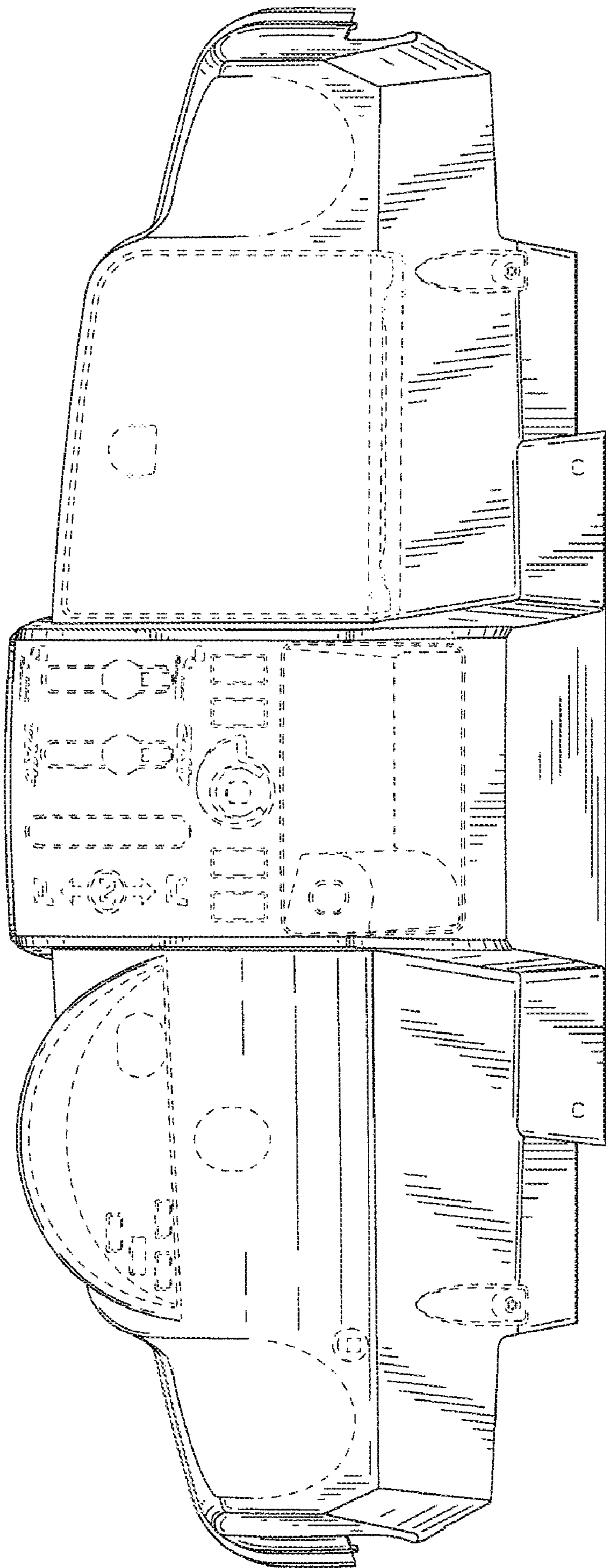

FIG. 2

FIG. 3

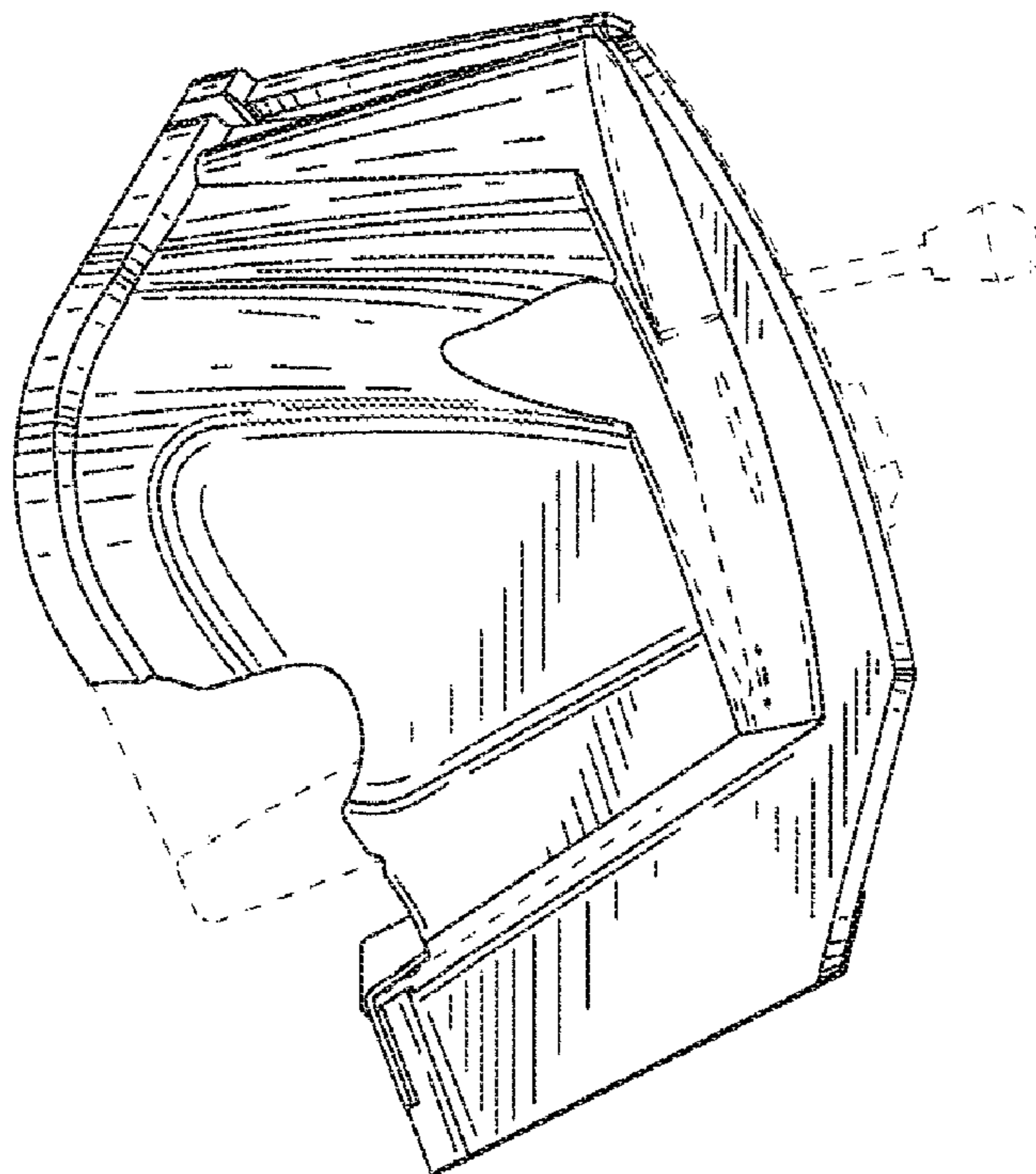
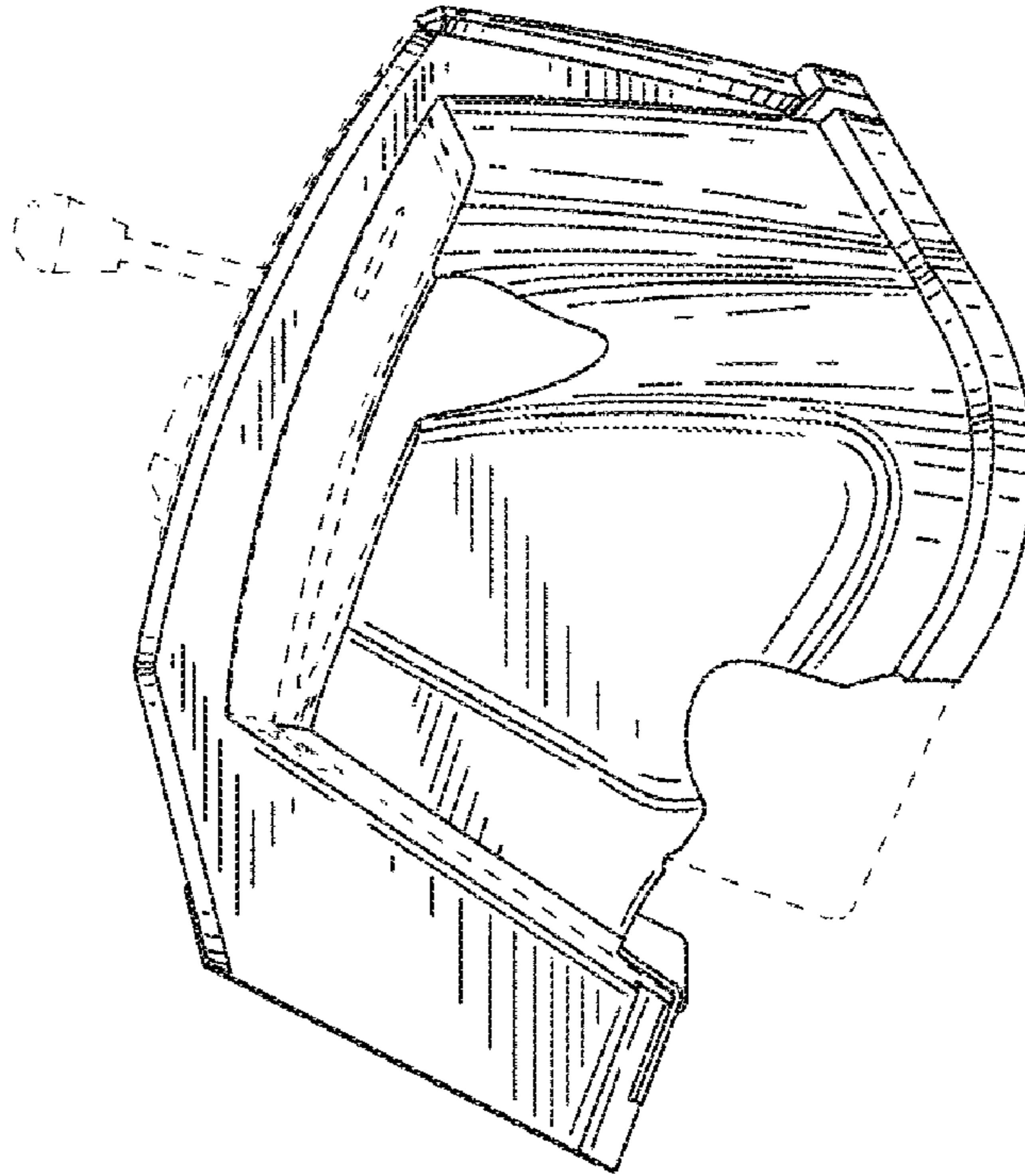

FIG. 4

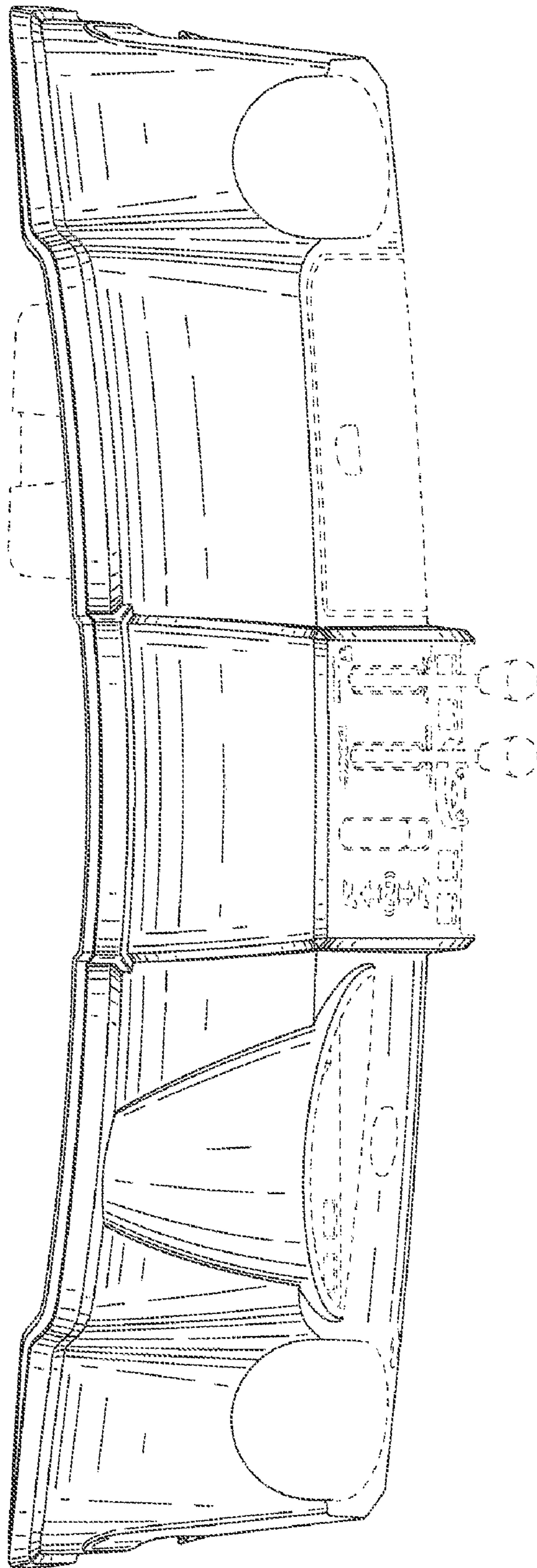

FIG. 5