



US00D595184S

(12) **United States Design Patent**  
**Yoshiguchi**

(10) **Patent No.:** **US D595,184 S**  
(45) **Date of Patent:** **\*\* Jun. 30, 2009**

(54) **BUCKLE**

(57) **CLAIM**

(75) Inventor: **Manabu Yoshiguchi**, Kamakura (JP)

The ornamental design for a buckle, as shown and described.

(73) Assignee: **Nifco Inc.**, Yokohama-Shi,  
Kanagawa-Ken (JP)

**DESCRIPTION**

(\*\*) Term: **14 Years**

FIG. 1 is a perspective view of a buckle showing my new design;

(21) Appl. No.: **29/309,989**

FIG. 2 is a plan view thereof;

(22) Filed: **Nov. 26, 2008**

FIG. 3 is a front view thereof;

(30) **Foreign Application Priority Data**

FIG. 4 is a bottom view thereof;

May 28, 2008 (JP) ..... 2008-013338

FIG. 5 is a sectional view thereof taken along line 5—5 in FIG. 2;

(51) **LOC (9) Cl.** ..... **02-07**

FIG. 6 is a left side view thereof;

(52) **U.S. Cl.** ..... **D11/216**

FIG. 7 is a right side view thereof;

(58) **Field of Classification Search** ..... D11/1-2,  
D11/86, 87, 200-201, 206-210, 212-216,  
D11/218; 24/163 R, 169-171, 173, 177-179,  
24/191, 194-195, 197, 200, 303

FIG. 8 is a plan view of a female member of the buckle;

See application file for complete search history.

FIG. 9 is a front view of the female member of the buckle;

(56) **References Cited**

FIG. 10 is a bottom view of the female member of the buckle;

**U.S. PATENT DOCUMENTS**

FIG. 11 is a left side view of the female member of the buckle;

D373,974 S \* 9/1996 Anscher ..... D11/216  
D400,474 S \* 11/1998 Chou ..... D11/216  
D472,500 S \* 4/2003 Uehara et al. .... D11/216  
D521,410 S \* 5/2006 Nottingham et al. .... D11/216

FIG. 12 is a right side view of the female member of the buckle;

\* cited by examiner

FIG. 13 is a plan view of a male member of the buckle;

*Primary Examiner*—R. Seifert

FIG. 14 is a front view of the male member of the buckle;

(74) *Attorney, Agent, or Firm*—Manabu Kanesaka

FIG. 15 is a bottom view of the male member of the buckle;

FIG. 16 is a left side view of the male member of the buckle;  
and,

FIG. 17 is a right side view of the male member of the buckle.

**1 Claim, 7 Drawing Sheets**

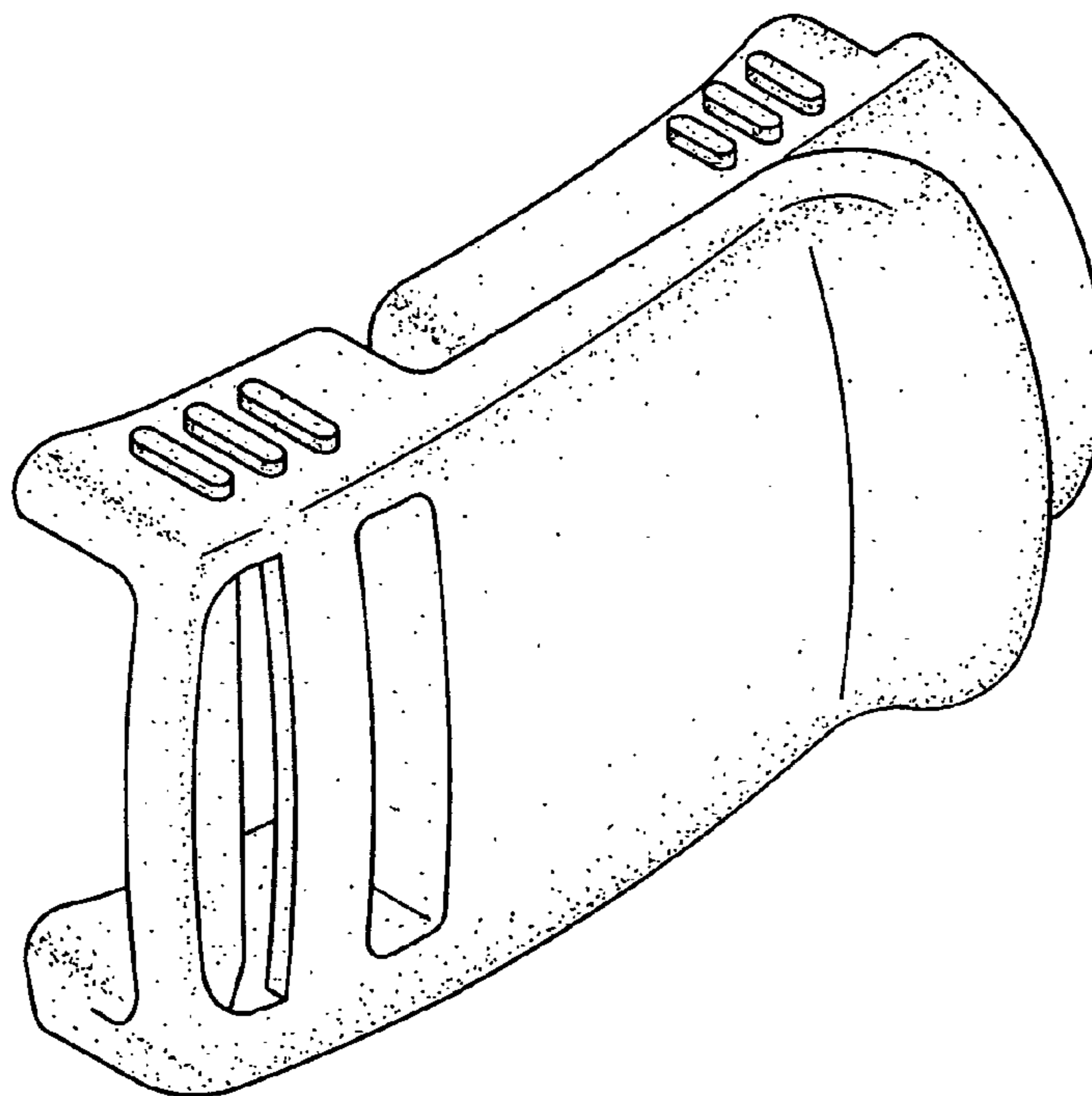

Fig. 1

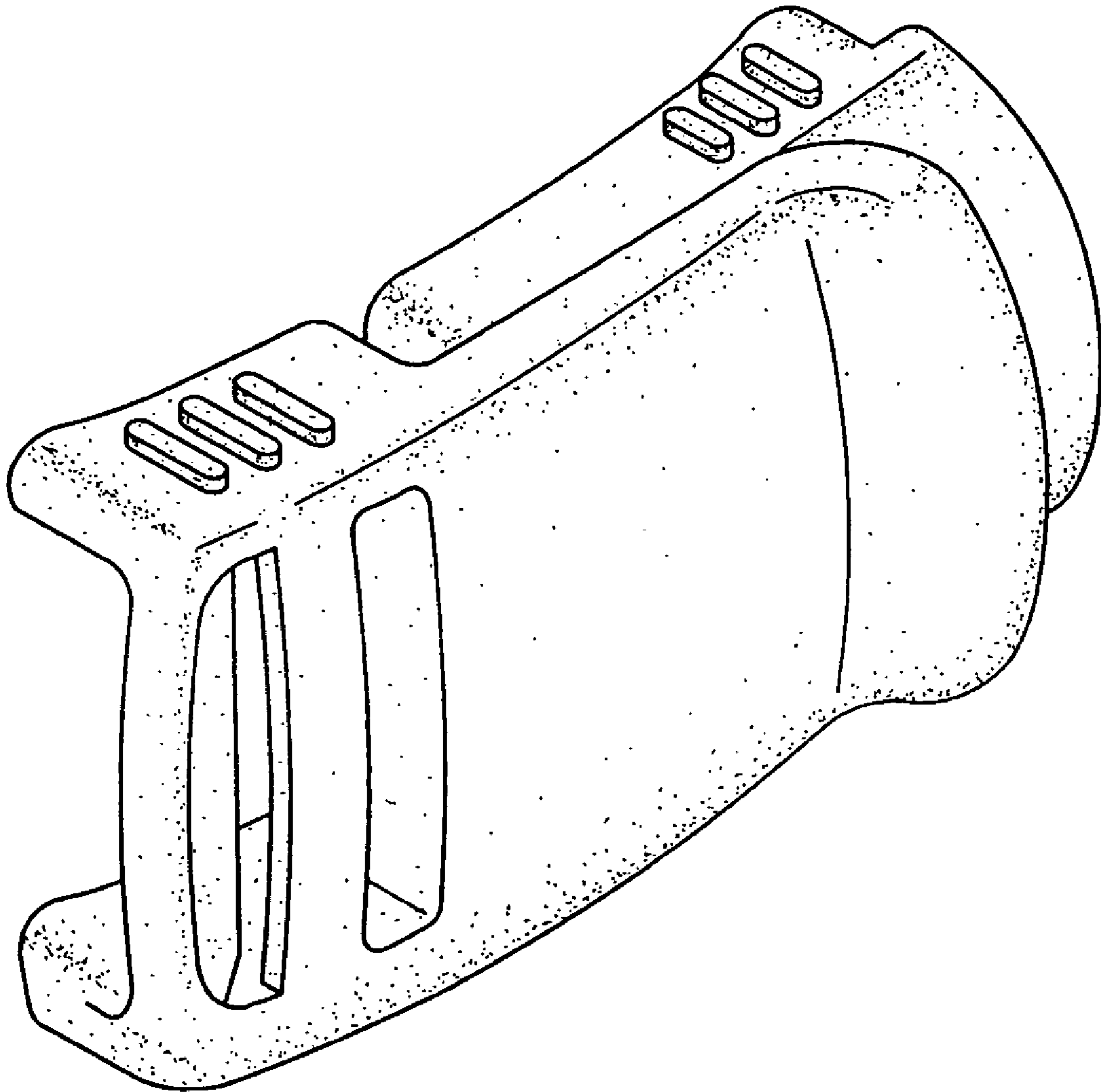

Fig. 2

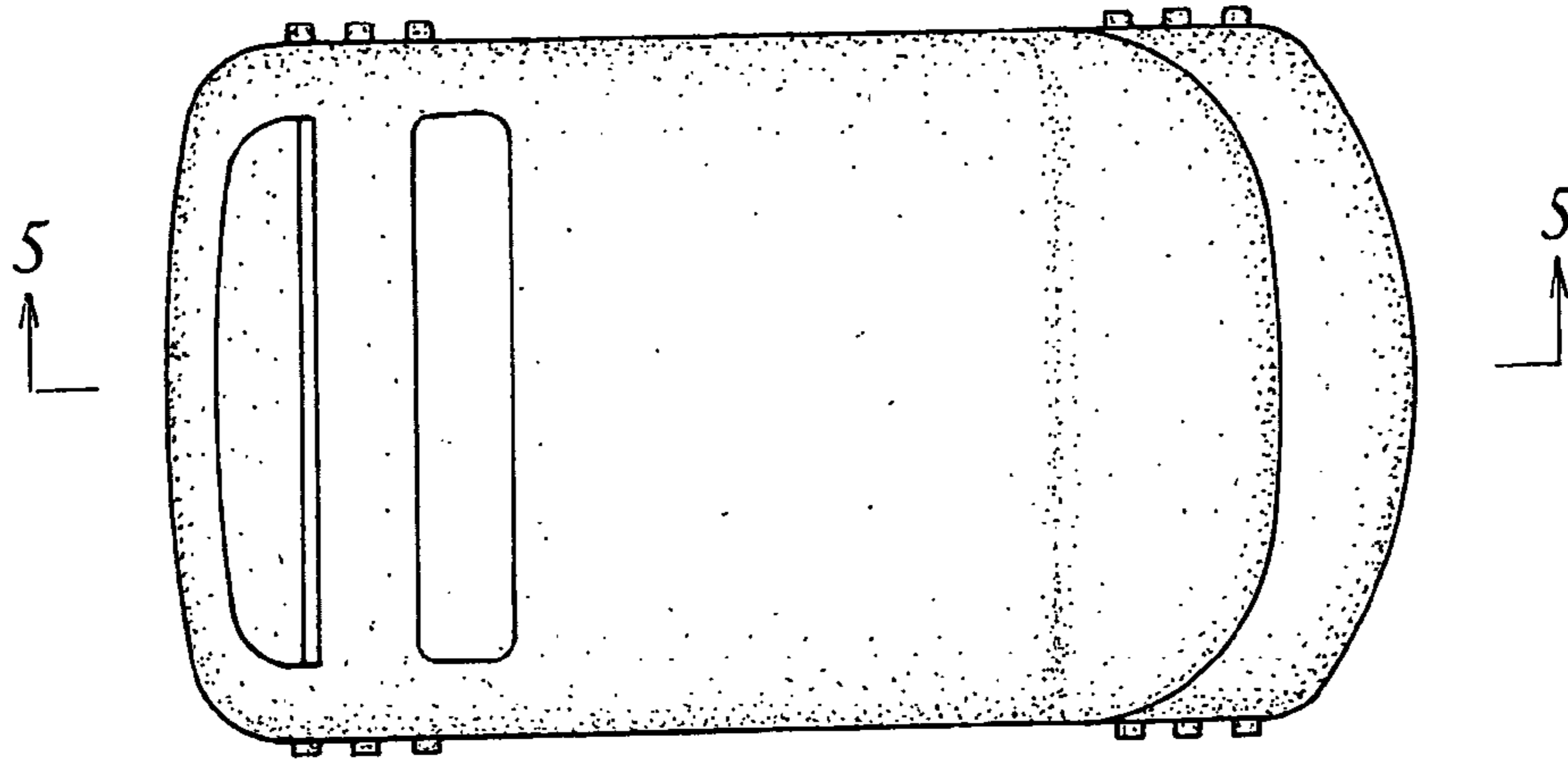

Fig. 3

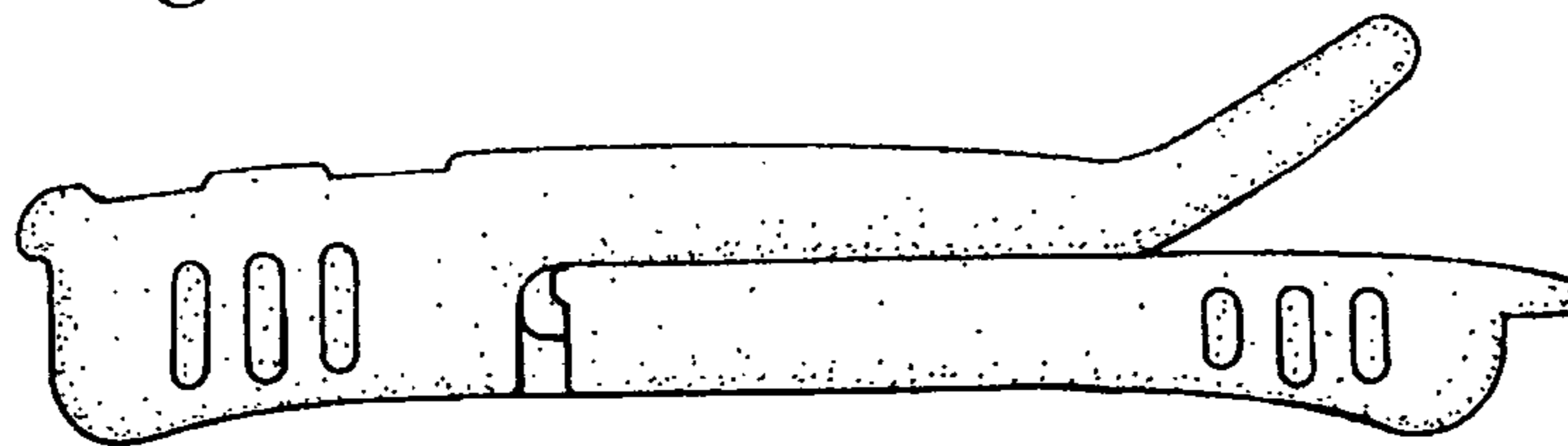

Fig. 4

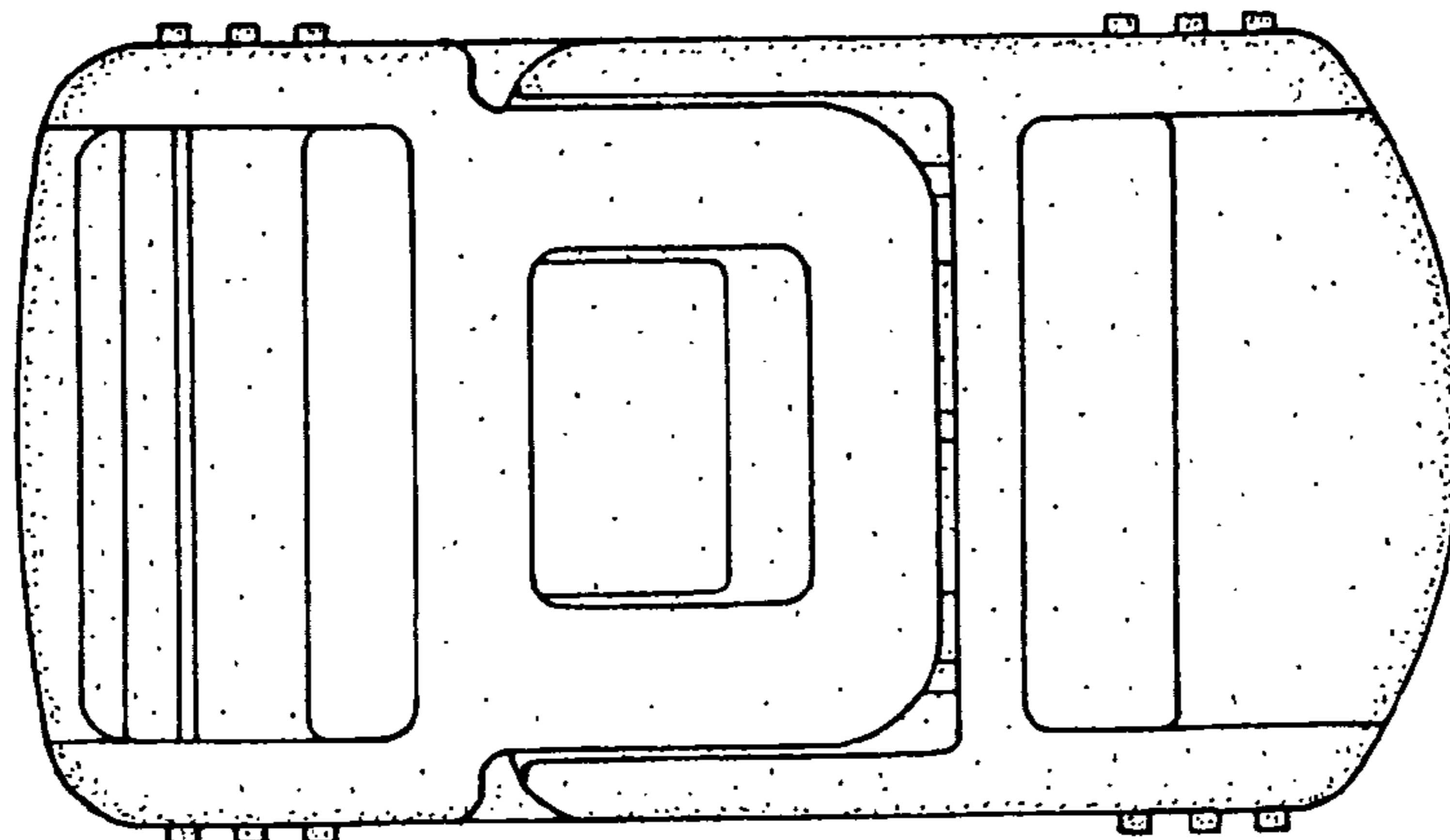

Fig. 5

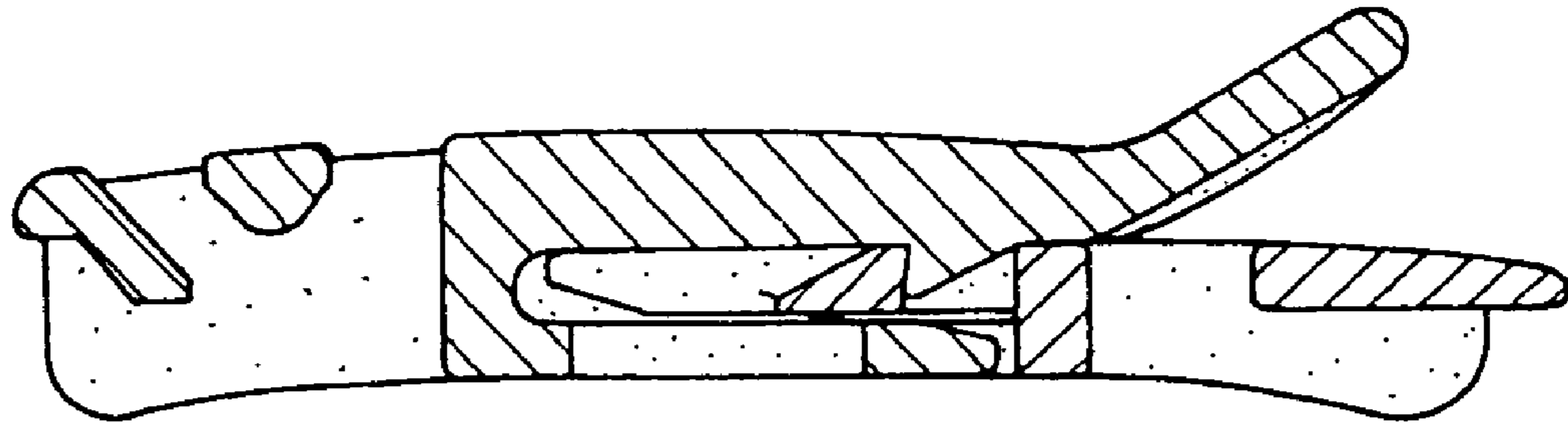

Fig. 6

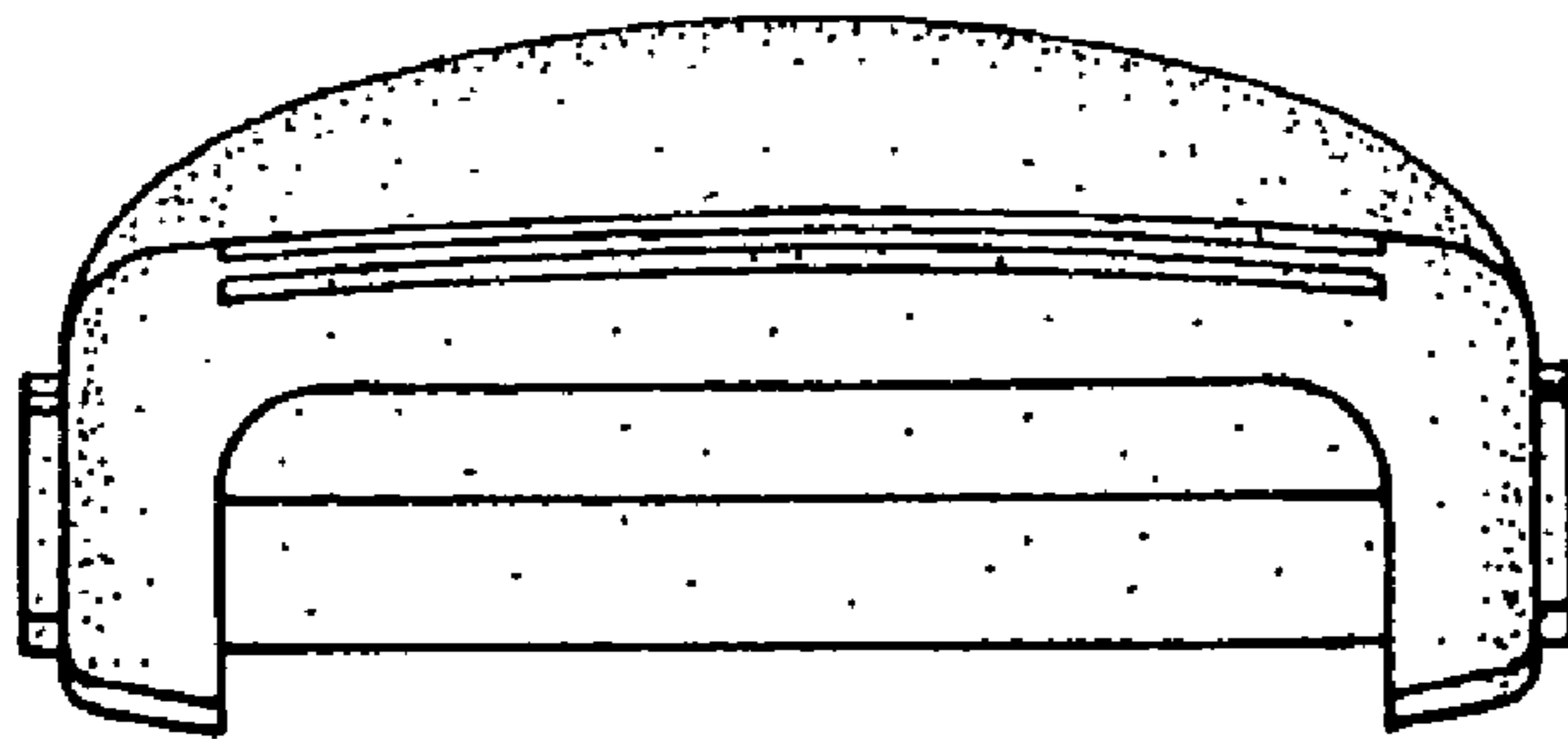

Fig. 7

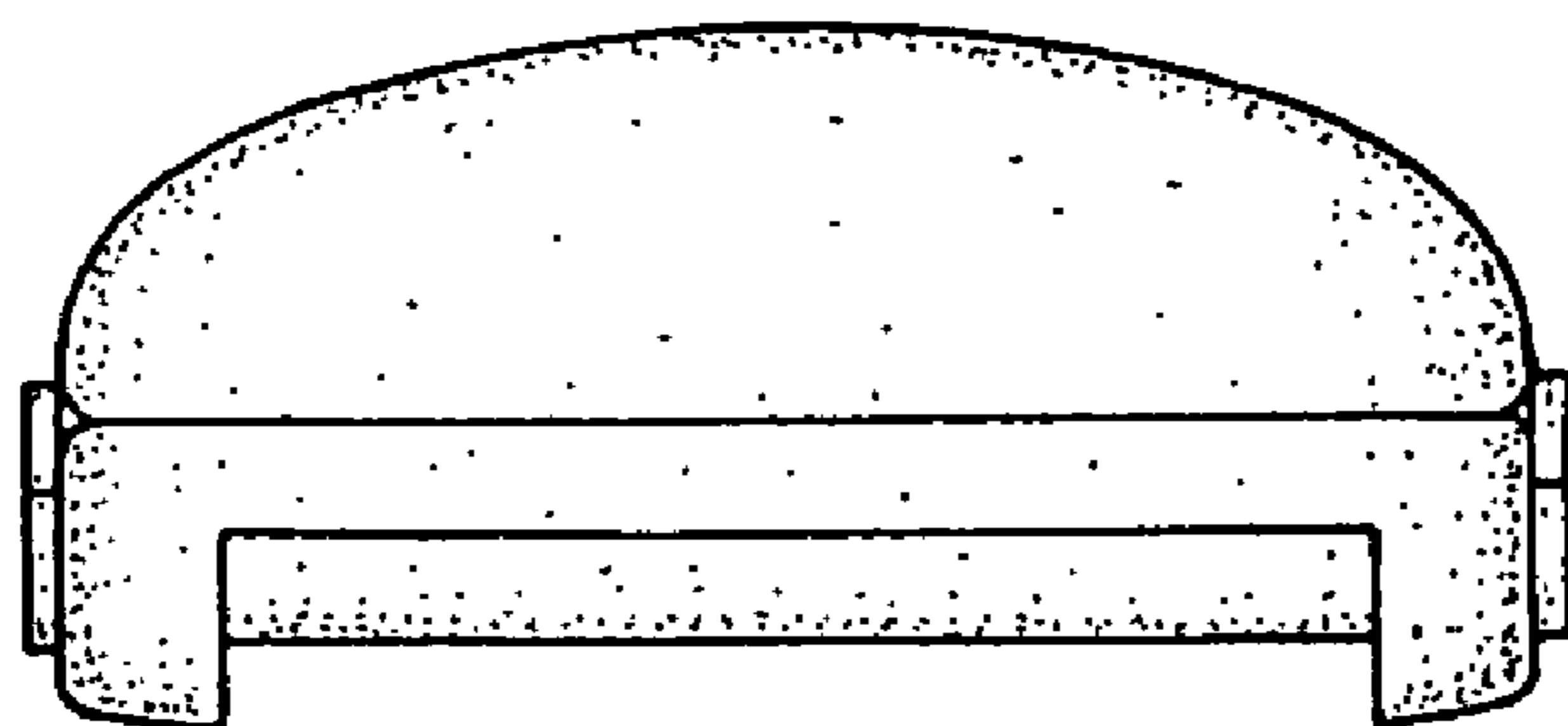

Fig. 8

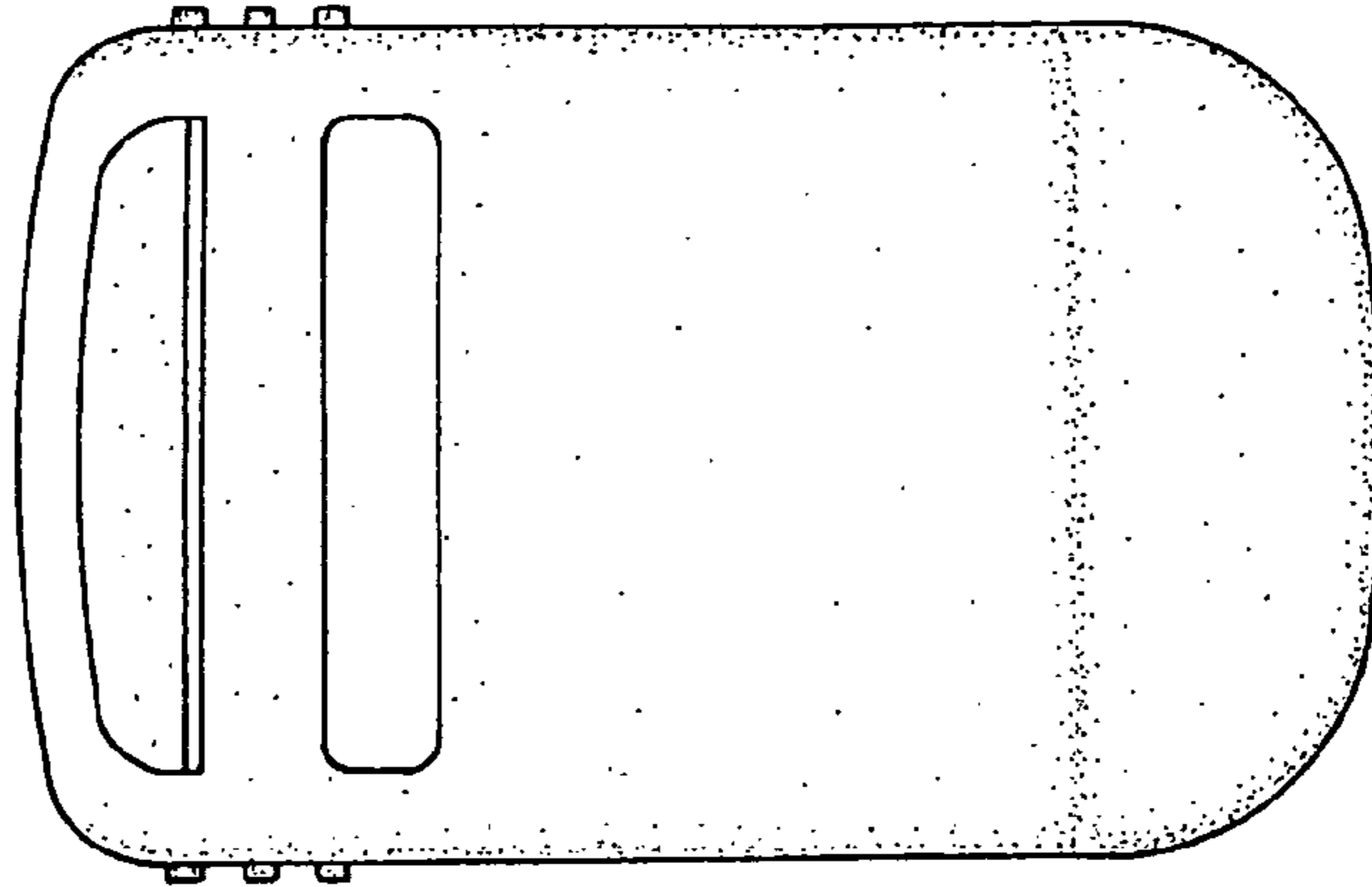

Fig. 9

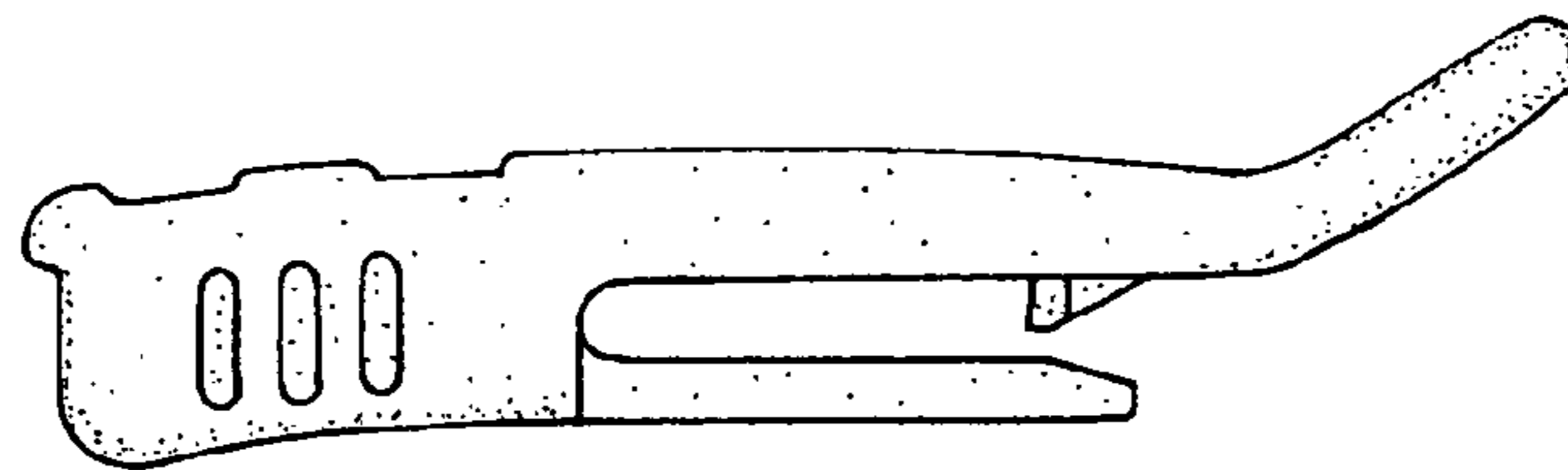

Fig. 10

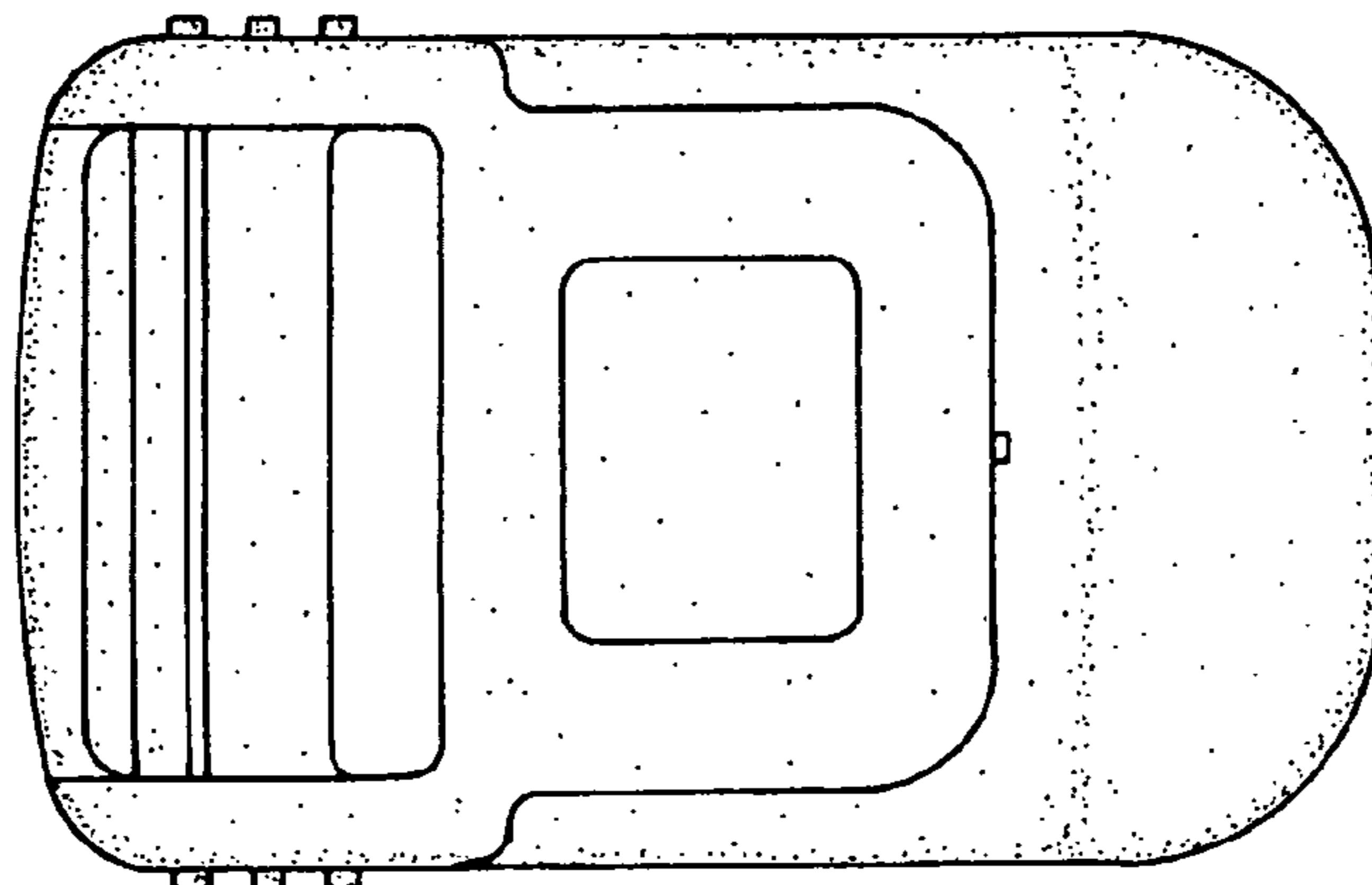

Fig. 11

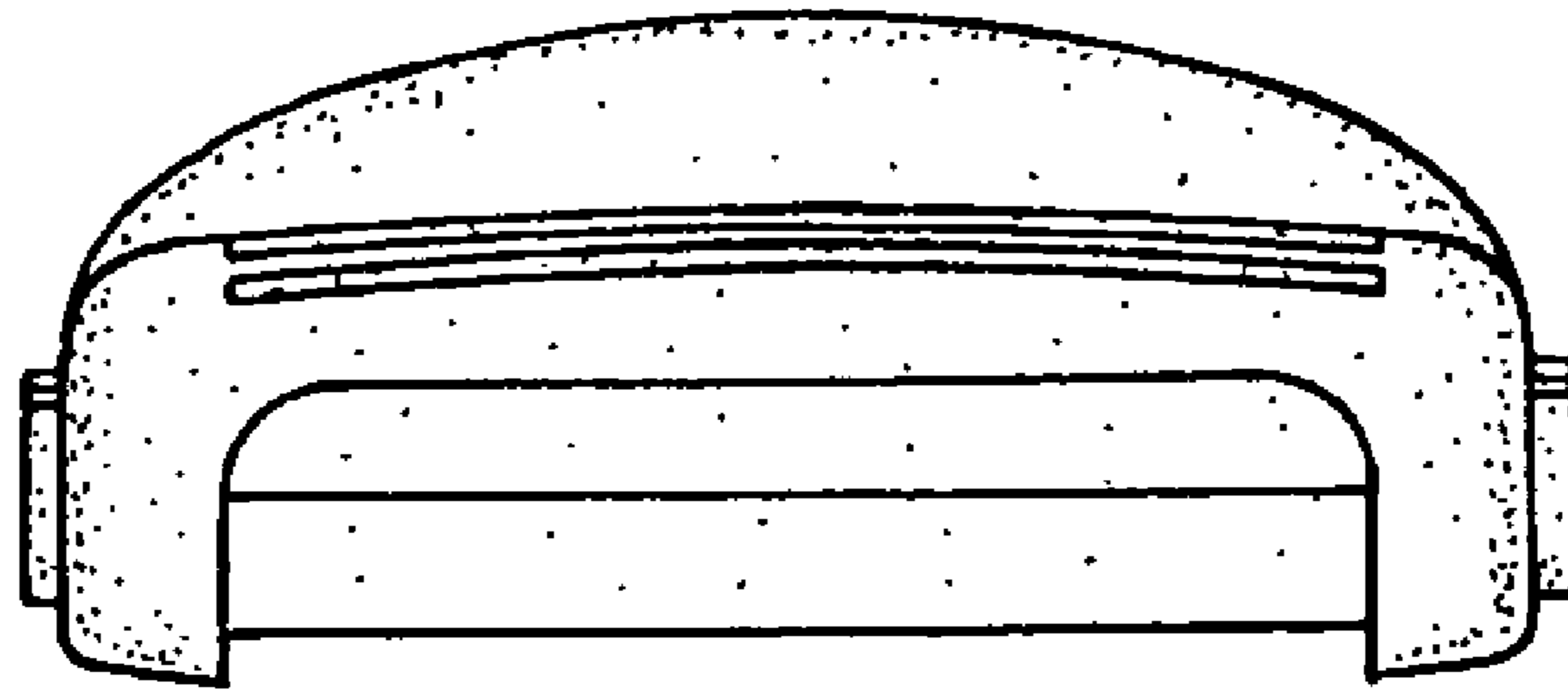

Fig. 12

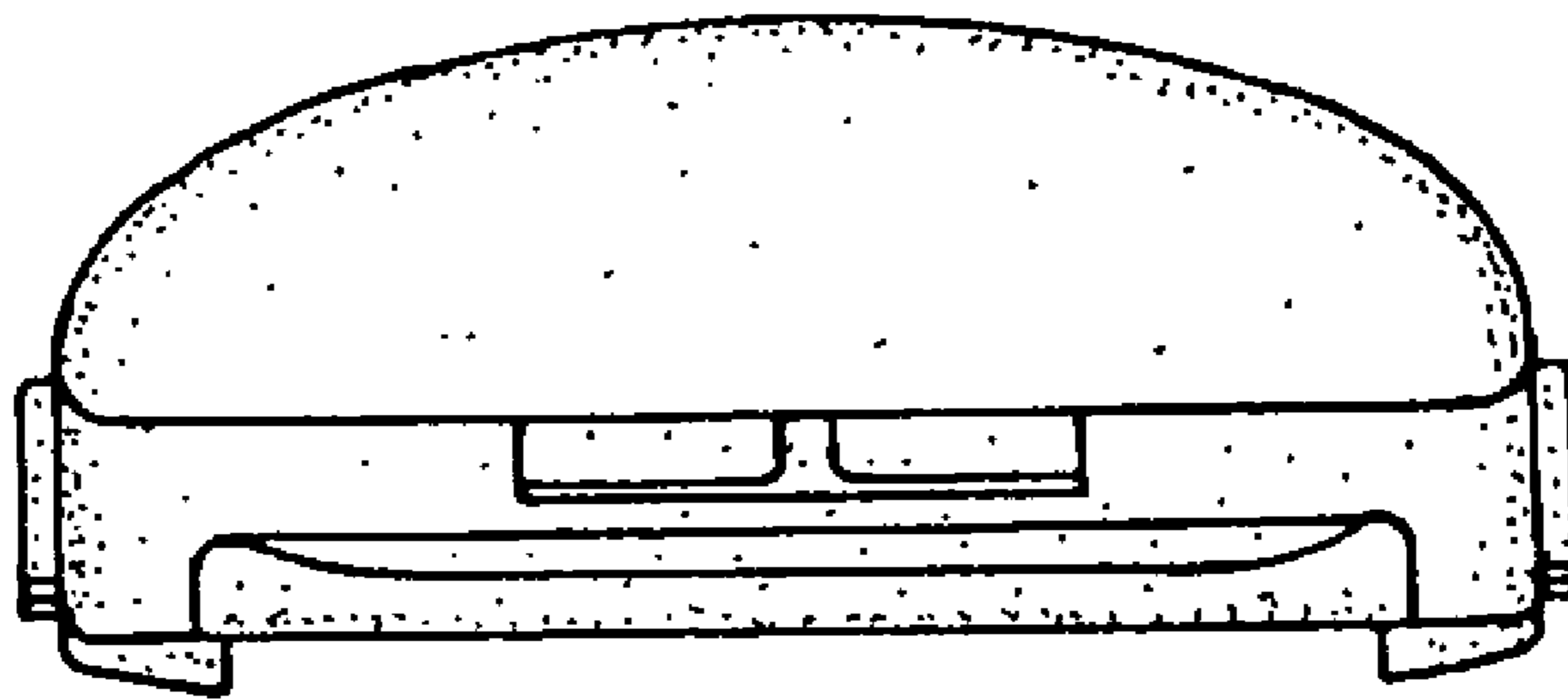

Fig. 13

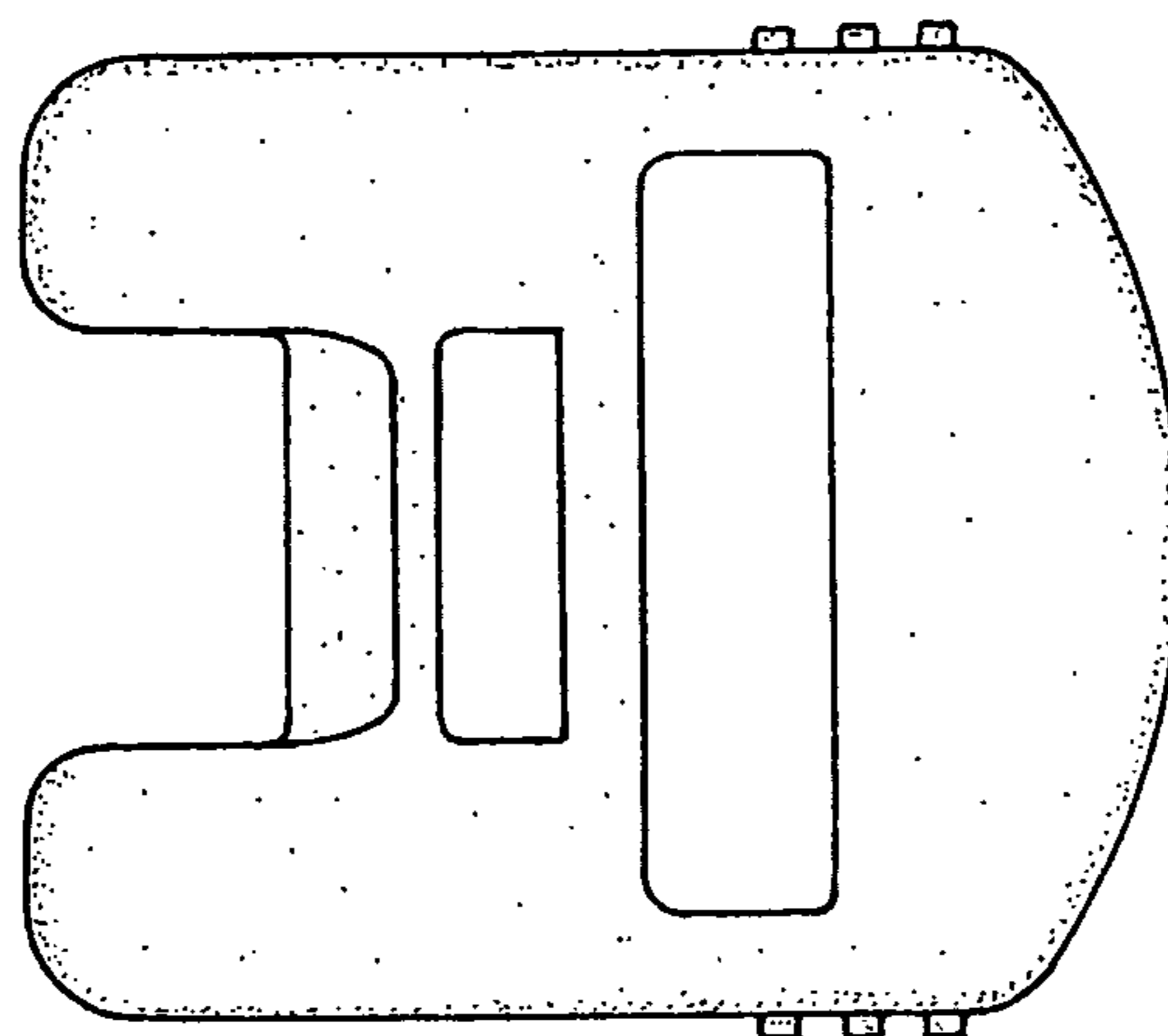

Fig. 14



Fig. 15

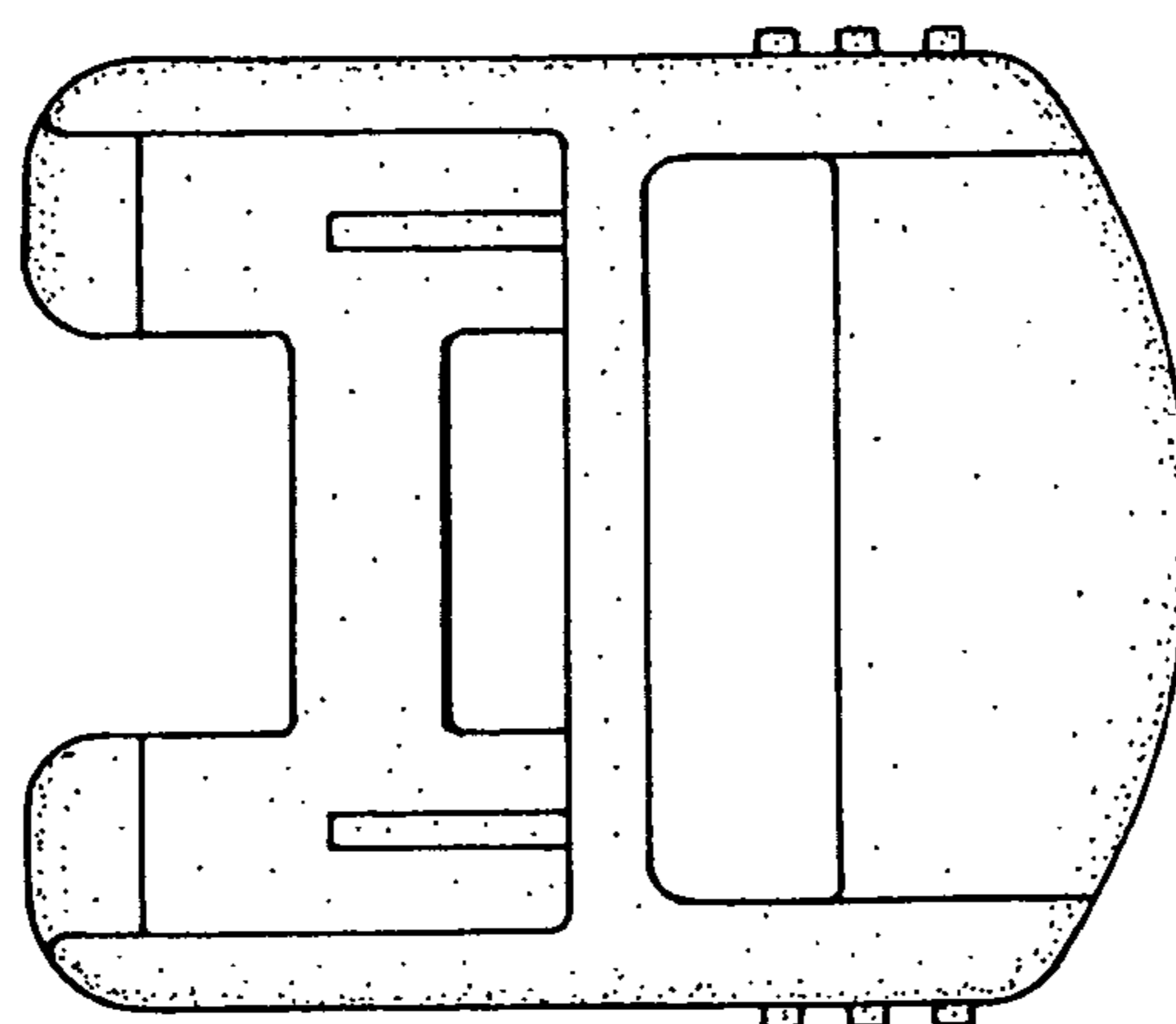

Fig. 16

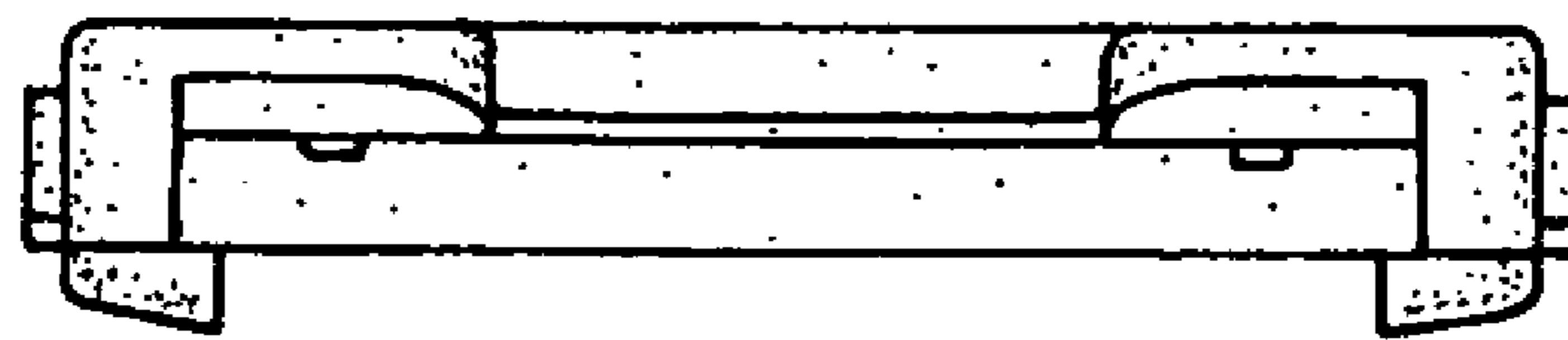

Fig. 17

