

US00D595132S

(12) **United States Design Patent**
Tseng

(10) **Patent No.:** **US D595,132 S**
(45) **Date of Patent:** **** Jun. 30, 2009**

(54) **SPRAYING HEAD FOR BOTTLE WITH
CLEANING AGENT THEREIN**

D427,527 S * 7/2000 Wise D9/448
D466,017 S * 11/2002 Kuo D9/448
D499,966 S * 12/2004 Arminak D9/448

(75) Inventor: **Sen-Li Tseng**, Taichung (TW)

* cited by examiner

(73) Assignee: **Hsih Tung Tooling Co., Ltd.**, Taichung (TW)

Primary Examiner—Susan Bennett Hattan

(**) Term: **14 Years**

(57) **CLAIM**

(21) Appl. No.: **29/263,324**

The ornamental design for a spraying head for bottle with cleaning agent therein, as shown and described.

(22) Filed: **Jul. 21, 2006**

DESCRIPTION

(51) **LOC (9) Cl.** **09-07**

FIG. 1 is a perspective view of a spraying head for bottle with cleaning agent therein;

(52) **U.S. Cl.** **D9/448**

FIG. 2 is a left side elevational view thereof;

(58) **Field of Classification Search** D9/686,
D9/682, 525, 448, 447, 694; D6/550, 543,
D6/542; 222/631, 566, 555, 551, 190; D8/309
See application file for complete search history.

FIG. 3 is a right side elevational view thereof;

FIG. 4 is a front elevational view thereof;

FIG. 5 is a rear elevational view thereof;

(56) **References Cited**

FIG. 6 is a top plan view thereof; and,

FIG. 7 is a perspective view showing one application of the present invention, wherein the shading lines form no part of the claimed design.

U.S. PATENT DOCUMENTS

D272,988 S * 3/1984 Podall et al. D9/448
D381,580 S * 7/1997 Kokenge et al. D9/447
D392,887 S * 3/1998 Wadsworth D9/448
D416,154 S * 11/1999 Diehl D6/542

1 Claim, 5 Drawing Sheets

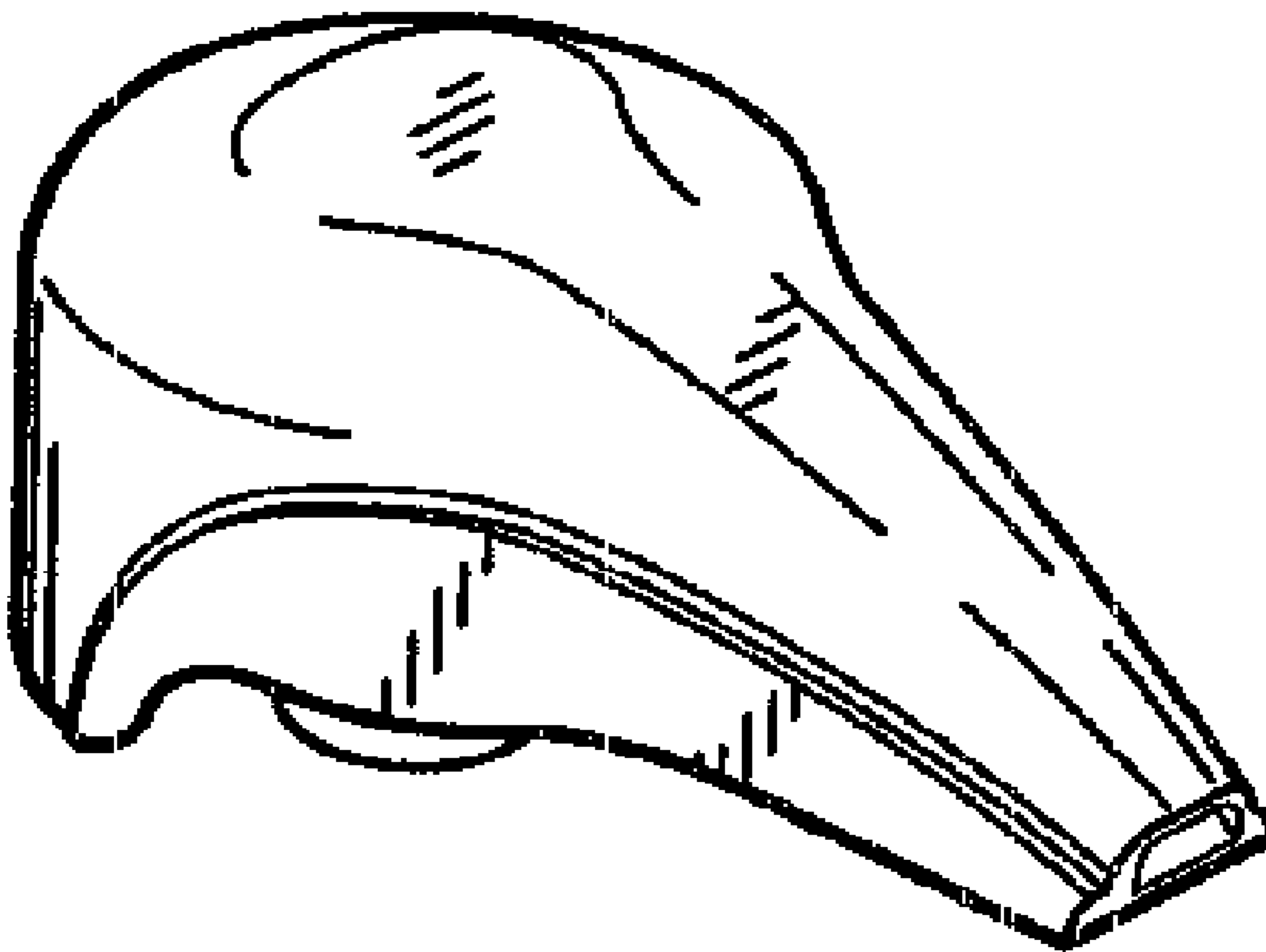

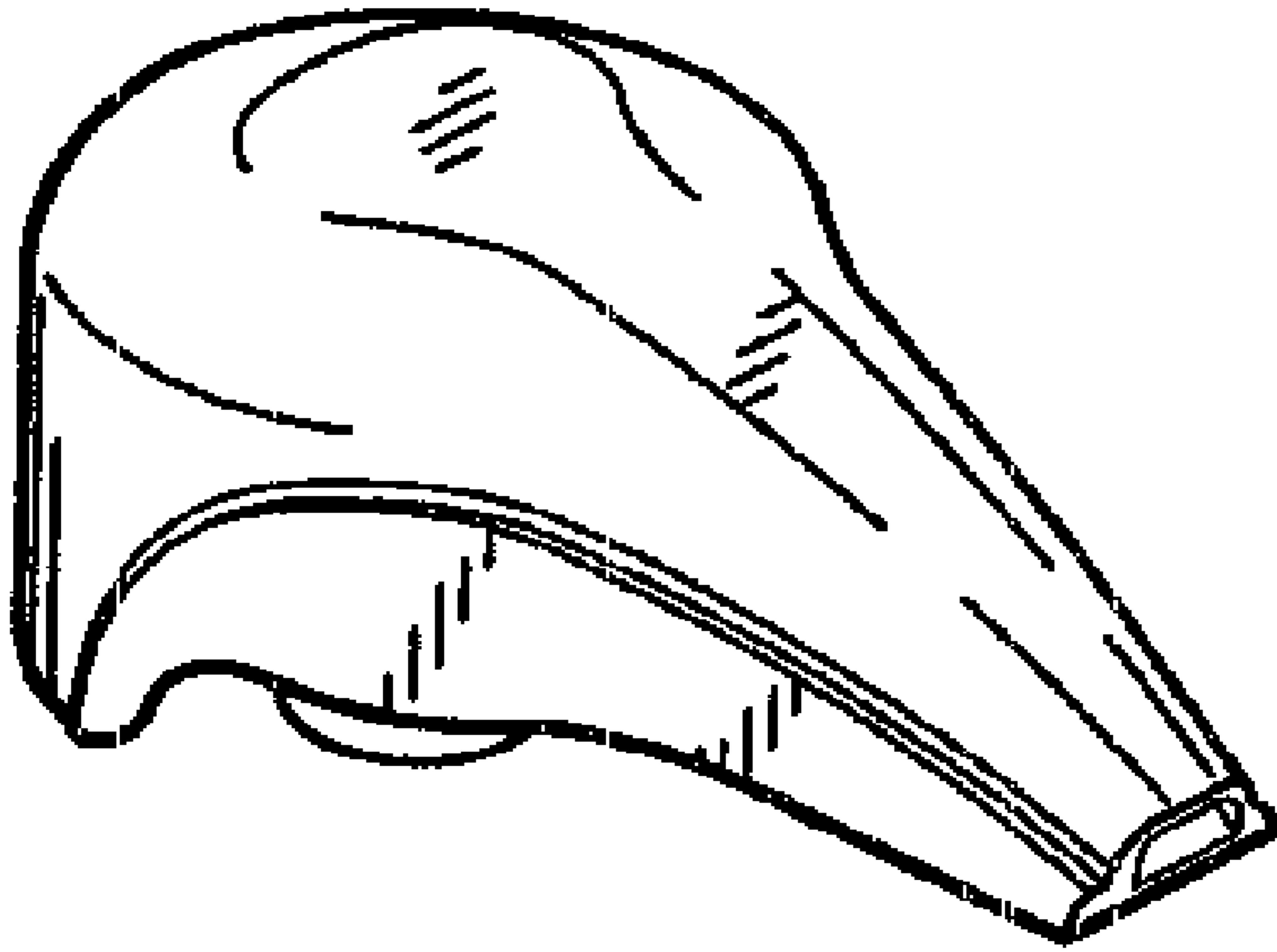

FIG. 1

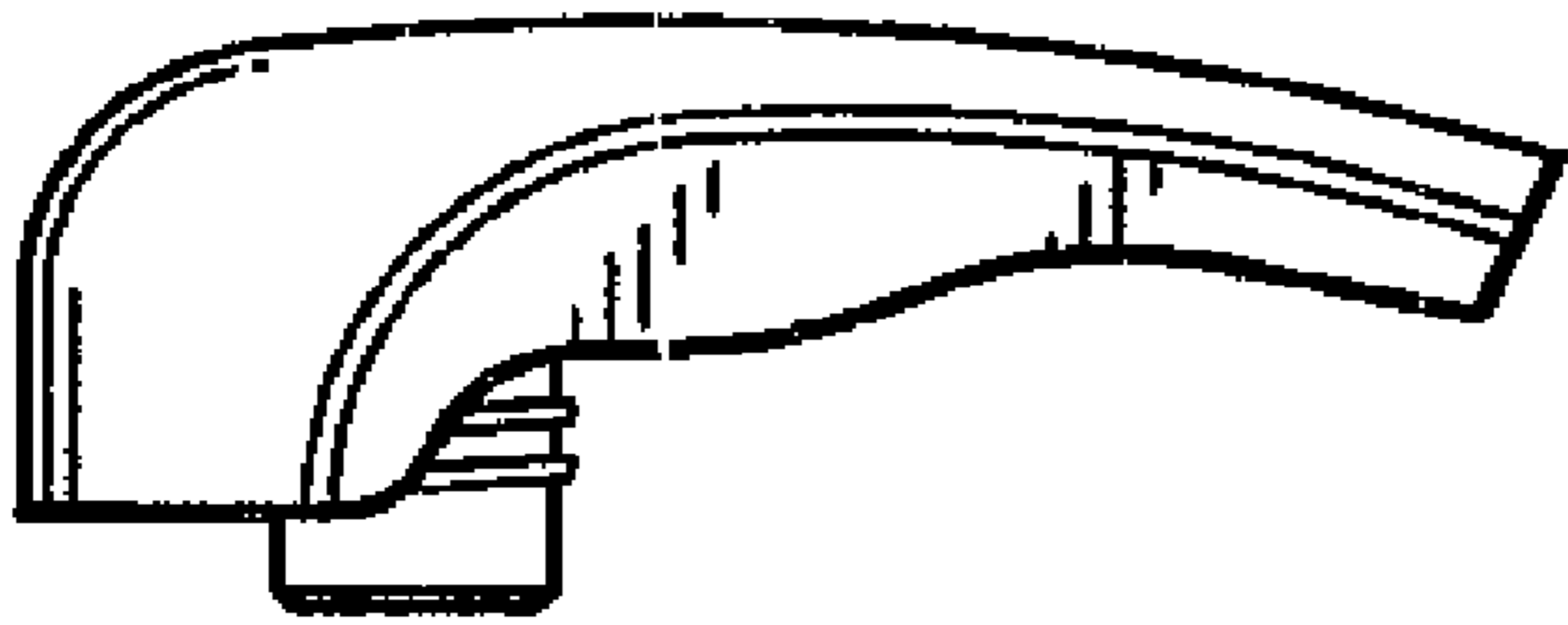

FIG. 2

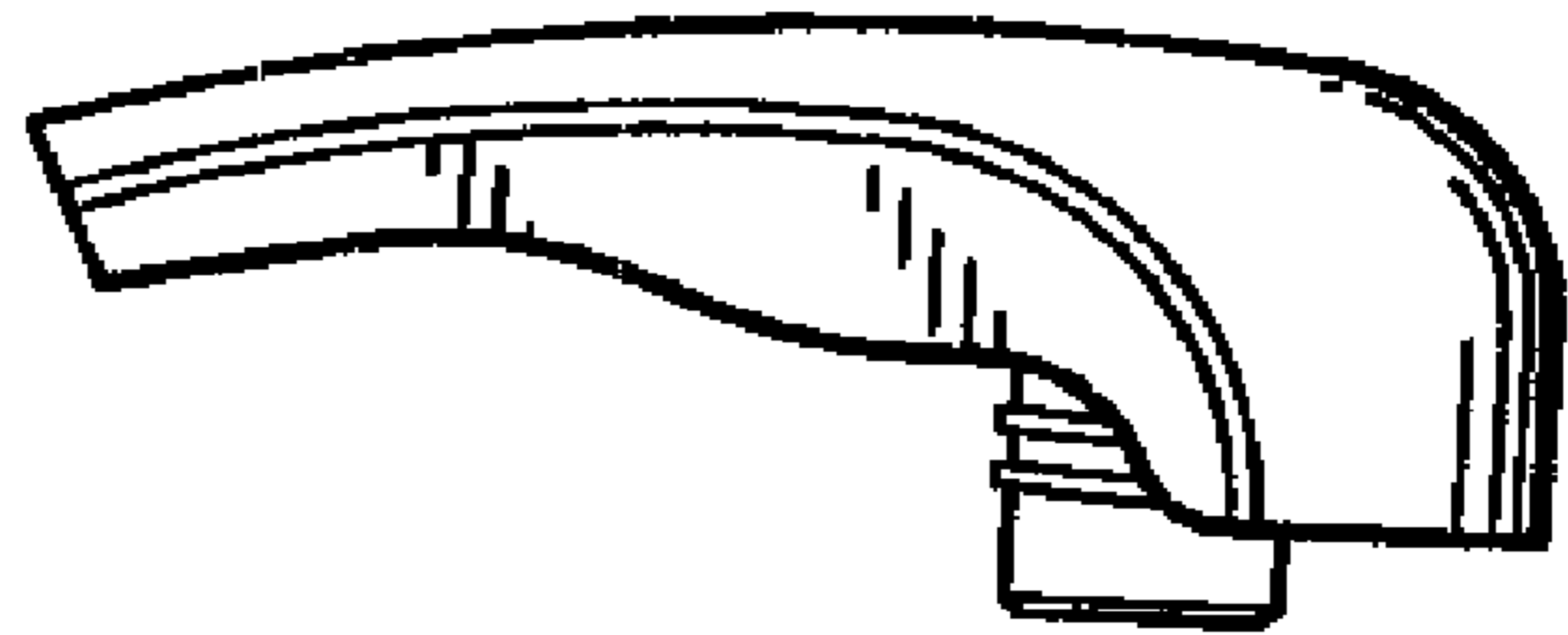

FIG. 3

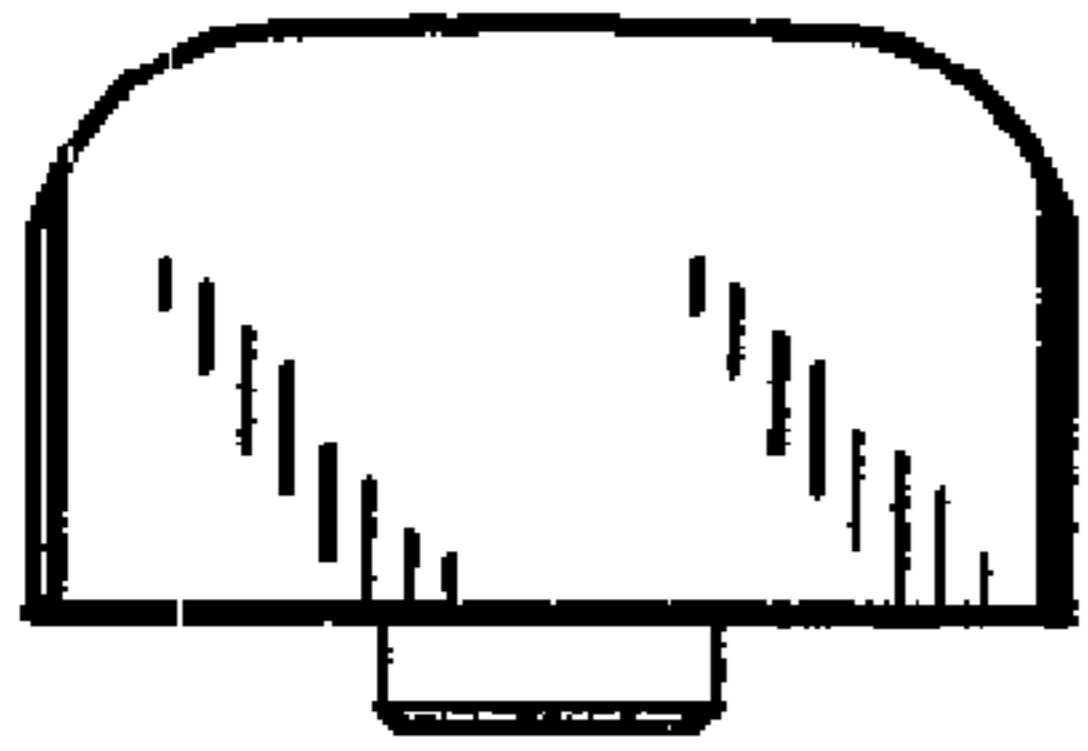

FIG. 4

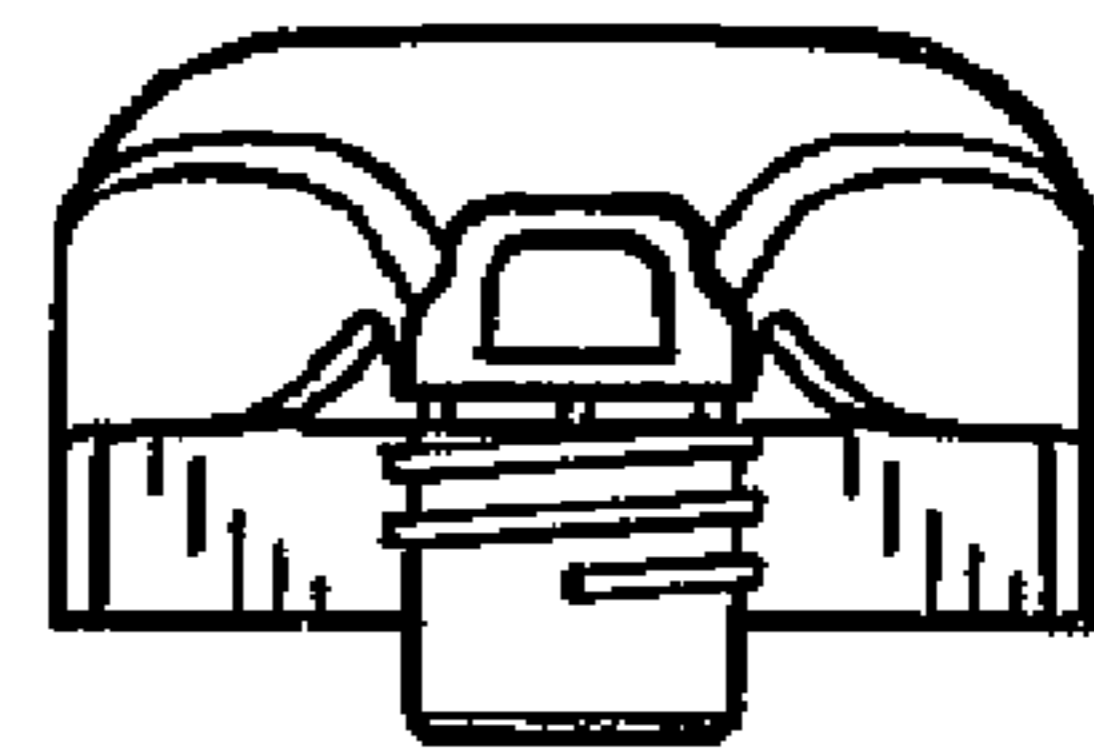

FIG. 5

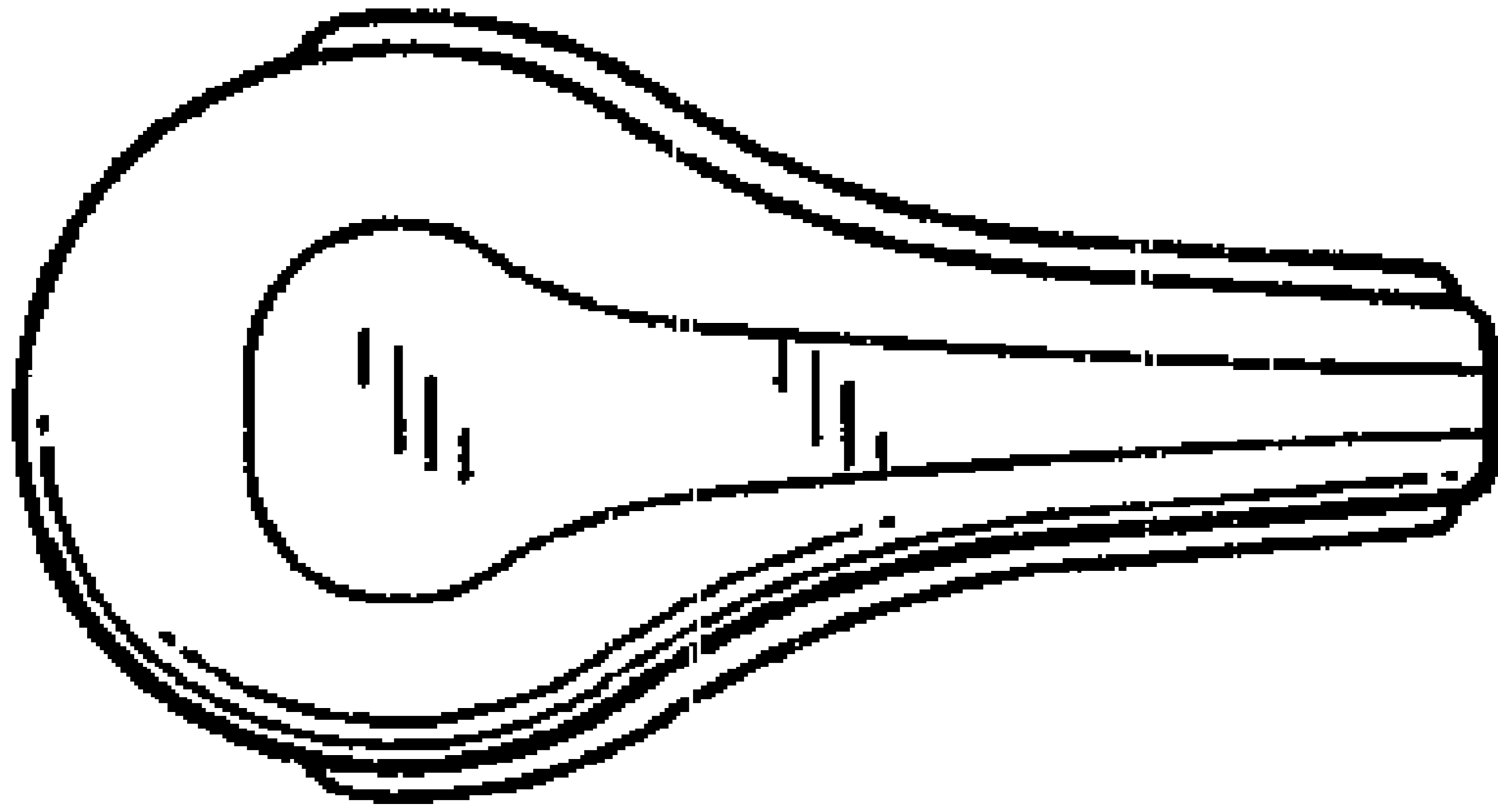

Fig. 6

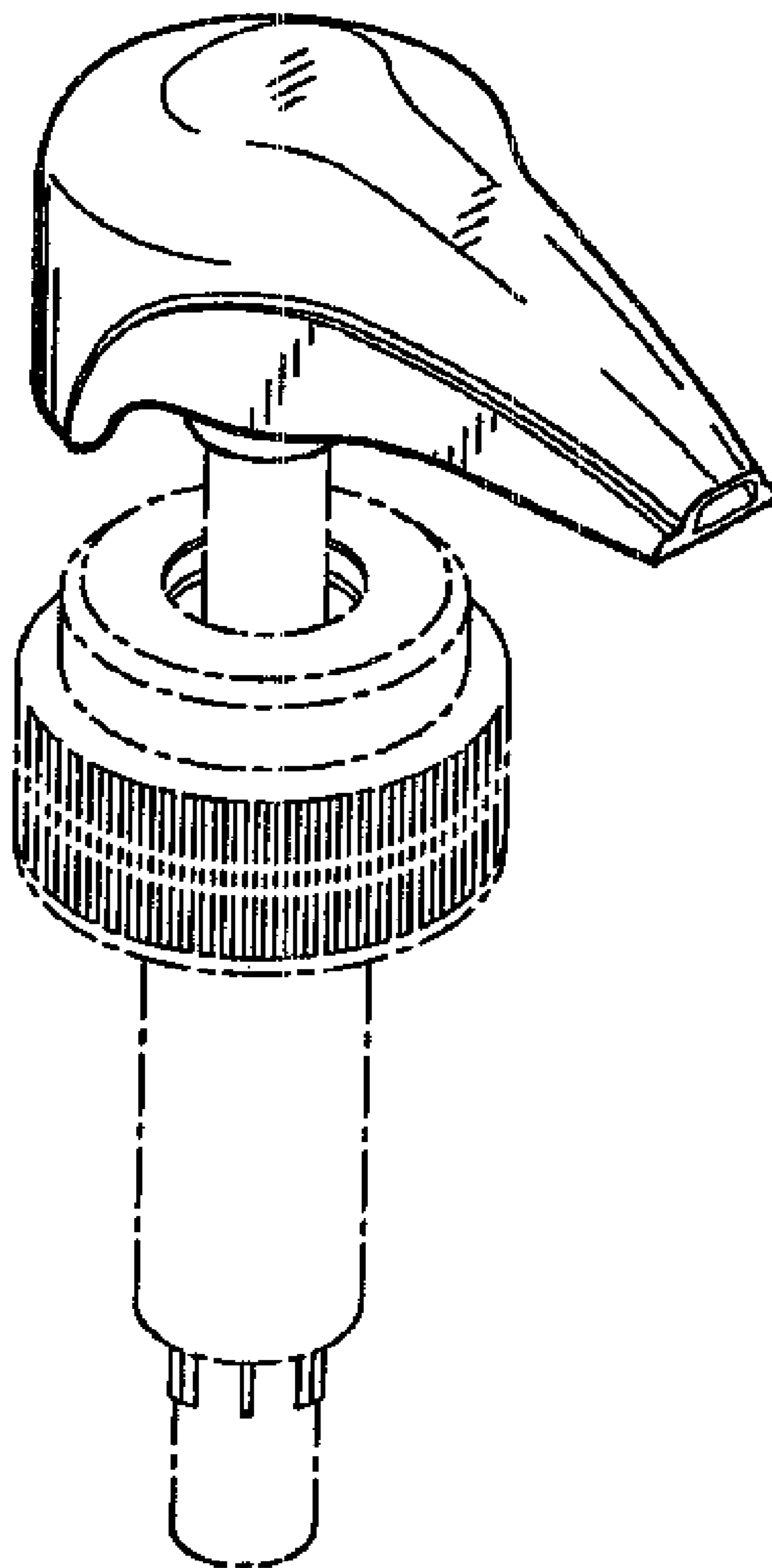

Fig. 7