



US00D594988S

(12) **United States Design Patent**
Huffman

(10) **Patent No.:** **US D594,988 S**
(45) **Date of Patent:** **** Jun. 23, 2009**

(54) **QUADRANT DENTAL ARTICULATOR BASE**

(76) Inventor: **Ronald E. Huffman**, P.O. Box 68440,
Oro Valley, AZ (US) 85704

(**) Term: **14 Years**

(21) Appl. No.: **29/324,218**

(22) Filed: **Sep. 9, 2008**

Related U.S. Application Data

(63) Continuation of application No. 29/256,968, filed on
Mar. 28, 2006, now Pat. No. Des. 576,732.

(51) **LOC (9) Cl.** **24-02**

(52) **U.S. Cl.** **D24/182**

(58) **Field of Classification Search** D24/155–157,
D24/133, 107, 181, 182; 128/848, 859; 602/902;
623/1.13–1.17, 44, 16.11, 17.11; 604/1.02;
433/141.1, 121; 81/119

See application file for complete search history.

(56) **References Cited**

U.S. PATENT DOCUMENTS

603,803	A *	5/1898	White	433/37
921,791	A	5/1909	Benson	
967,086	A	8/1910	Tuttle	
1,013,028	A	12/1911	Lee	
1,314,223	A	8/1919	Sorensen	
1,745,570	A	2/1930	Dimelow	
1,772,027	A	8/1930	Baumgarten	
1,780,117	A	10/1930	Craigo	
2,031,996	A	2/1936	Zelesnick	
2,037,344	A	4/1936	Schwartz	
2,234,411	A	3/1941	McDonald	
2,376,384	A	5/1945	Ringle et al.	
2,398,671	A	4/1946	Saffir	
2,577,420	A	12/1951	Jablonski et al.	
2,585,857	A	2/1952	Schwartz	
2,613,440	A	10/1952	Murray et al.	
2,621,407	A	12/1952	Schlesinger	
2,669,780	A	2/1954	Mann	

2,758,374	A	8/1956	Fisher et al.	
2,765,533	A	10/1956	McMorris	
2,827,899	A	3/1958	Altieri	
2,842,845	A	7/1958	Carlson	
2,963,786	A *	12/1960	Browning	433/37
3,150,448	A	9/1964	Wozar	
3,236,235	A	2/1966	Jacobs	
3,247,844	A	4/1966	Berghash	

(Continued)

FOREIGN PATENT DOCUMENTS

DE 3 436 094 A1 3/1985

(Continued)

Primary Examiner—Charles A Rademaker

(74) *Attorney, Agent, or Firm*—Holland & Hart, LLP

(57) **CLAIM**

The ornamental design for a quadrant dental articulator base,
as shown and described.

DESCRIPTION

FIG. 1 is a top and front top perspective view of a quadrant
dental articulator base showing my new design;

FIG. 2 is a top and rear perspective view thereof;

FIG. 3 is a bottom and front perspective view thereof;

FIG. 4 is a bottom and rear perspective view thereof;

FIG. 5 is a left side elevation thereof;

FIG. 6 is a right side elevation thereof;

FIG. 7 is a top plan view thereof;

FIG. 8 is a bottom plan view thereof;

FIG. 9 is a front elevation thereof; and,

FIG. 10 is a rear elevation thereof.

The broken lines shown in the drawings are included for the
purpose of illustrating environmental structures and form no
part of the claimed design.

1 Claim, 4 Drawing Sheets

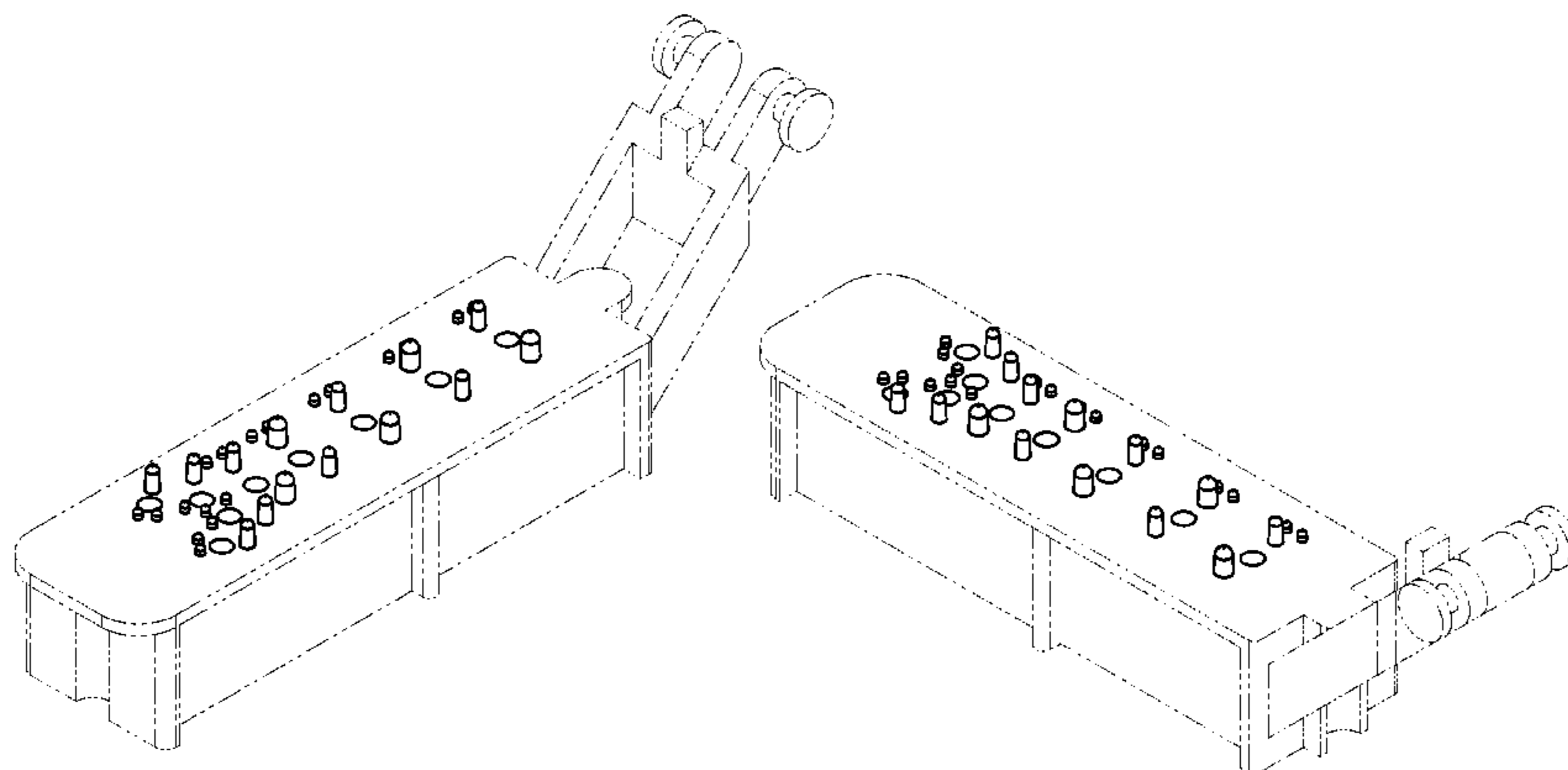

US D594,988 S

U.S. PATENT DOCUMENTS					
			4,767,331 A	8/1988	Hoe
			4,786,253 A	11/1988	Morais
			4,834,651 A	5/1989	Fenick
			4,842,242 A	6/1989	Huffman
			D302,456 S	7/1989	Huffman
			D302,587 S	8/1989	Huffman
			D302,724 S	8/1989	Huffman
			D302,725 S	8/1989	Huffman
			4,865,546 A	9/1989	Naylor
			RE33,099 E	10/1989	Shoher et al.
			4,886,453 A	12/1989	Ludwigs
			D305,361 S	1/1990	Huffman
			D305,362 S	1/1990	Huffman
			D306,206 S	2/1990	Huffman
			4,898,359 A	2/1990	Gopon
			4,917,347 A	4/1990	Fenick
			RE33,271 E	7/1990	Shoher et al.
			4,940,409 A	7/1990	Nordin
			4,980,124 A	12/1990	Dimmer
			D315,209 S	3/1991	Mann
			D315,955 S *	4/1991	Mann D24/181
			5,015,182 A	5/1991	Newberry
			5,028,235 A	7/1991	Smith
			5,044,949 A	9/1991	Xanthopoulos
			5,049,075 A	9/1991	Barrut
			5,076,789 A	12/1991	Tanaka
			D323,559 S	1/1992	Shafer
			5,098,290 A	3/1992	Honstein et al.
			5,100,317 A	3/1992	Darnand
			5,197,874 A	3/1993	Silva et al.
			5,207,574 A	5/1993	Garland
			5,352,117 A	10/1994	Silva
			5,393,227 A	2/1995	Nooning
			5,403,185 A	4/1995	Presswood
			5,466,152 A	11/1995	Walter
			5,470,231 A	11/1995	Stern
			5,501,600 A	3/1996	Johnson
			5,586,884 A	12/1996	Kraus
			5,622,497 A	4/1997	Cho
			5,645,425 A	7/1997	Callne
			5,722,828 A	3/1998	Halstrom
			5,766,007 A	6/1998	Huffman
			5,769,634 A	6/1998	Choi
			5,775,899 A	7/1998	Huffman
			5,788,489 A	8/1998	Huffman
			5,788,490 A	8/1998	Huffman
			5,800,166 A	9/1998	Huffman
			5,807,099 A	9/1998	Johnson
			5,868,138 A	2/1999	Halstrom
			5,868,569 A	2/1999	Huffman
			D408,919 S	4/1999	Cooley
			5,934,901 A	8/1999	Huffman
			5,970,981 A	10/1999	Ochel
			5,996,963 A	12/1999	Michael
			6,033,221 A	3/2000	Tsubota et al.
			D429,815 S	8/2000	Huffman
			D430,672 S	9/2000	Huffman
			D433,136 S	10/2000	Huffman
			D433,754 S	11/2000	Huffman
			6,149,428 A	11/2000	Mogensen
			6,186,781 B1	2/2001	Iba
			6,193,511 B1	2/2001	Hudson
			6,234,794 B1	5/2001	Ozaki
			D443,363 S	6/2001	Huffman
			D444,559 S	7/2001	Huffman
			D452,009 S	12/2001	Huffman
			D452,010 S	12/2001	Huffman
			D452,319 S	12/2001	Huffman
			D452,320 S	12/2001	Huffman
			D452,321 S	12/2001	Huffman
			D452,322 S	12/2001	Huffman
			D452,566 S	12/2001	Huffman
			D452,567 S	12/2001	Huffman

US D594,988 S

D452,568 S	12/2001	Huffman	
6,364,661 B1	4/2002	Brattesani	
D456,902 S	5/2002	Huffman	
D456,903 S	5/2002	Huffman	
D456,904 S	5/2002	Huffman	
D457,243 S	5/2002	Huffman	
D457,636 S	5/2002	Huffman	
D457,637 S	5/2002	Huffman	
D457,963 S	5/2002	Huffman	
D457,964 S	5/2002	Huffman	
6,425,759 B1	7/2002	Cronin	
D464,431 S	10/2002	Huffman	
D464,432 S	10/2002	Huffman	
D464,732 S	10/2002	Huffman	
D464,733 S	10/2002	Huffman	
D465,027 S	10/2002	Huffman	
6,471,513 B1	10/2002	Huffman	
D468,018 S	12/2002	Huffman	
D468,431 S	1/2003	Huffman	
D468,432 S	1/2003	Huffman	
D469,537 S	1/2003	Huffman	
6,511,318 B2	1/2003	Kim	
D481,797 S	11/2003	Huffman	
6,726,477 B2 *	4/2004	Gittleman 433/34	
D491,269 S *	6/2004	Tucker et al. D24/181	
6,884,068 B2	4/2005	Huffman	
6,886,566 B2	5/2005	Eubank	
6,910,888 B2	6/2005	Garland	
6,932,608 B1	8/2005	Gagliano et al.	
D512,148 S	11/2005	Kwok	
7,044,734 B2	5/2006	Huffman	
D529,177 S	9/2006	Huffman	
D529,178 S	9/2006	Huffman	
7,108,507 B2	9/2006	Huffman	
D530,014 S	10/2006	Huffman	
7,147,465 B2	12/2006	Jung et al.	
7,156,660 B2	1/2007	Huffman	
D537,987 S	3/2007	Manzo et al.	
D539,429 S	3/2007	Wong	
7,210,931 B1	5/2007	Huffman	
D547,452 S *	7/2007	Costello D24/182	
D551,767 S	9/2007	Costello	
D559,986 S *	1/2008	Huffman D24/176	
7,338,283 B2	3/2008	Honstein et al.	
7,341,451 B2	3/2008	Huffman	
7,347,689 B2	3/2008	Huffman	
D566,281 S	4/2008	Huffman	
D567,380 S	4/2008	Huffman	
D571,919 S	6/2008	Kwon et al.	
D573,712 S	7/2008	Huffman	
D575,404 S	8/2008	Huffman	
D575,873 S	8/2008	Huffman	
D576,732 S	9/2008	Huffman	

D576,733 S	9/2008	Huffman
D576,734 S	9/2008	Huffman
D582,559 S	12/2008	Khawaled et al.
2004/0096802 A1	5/2004	Gittleman
2005/0064364 A1	3/2005	Huffman
2005/0064365 A1	3/2005	Huffman
2006/0281043 A1	12/2006	Huffman
2007/0037115 A1	2/2007	Sim
2007/0231770 A1	10/2007	Huffman

FOREIGN PATENT DOCUMENTS

DE	3 505 680 A1	7/1985
DE	3 521 137 A1	12/1986
DE	3 825 014 A1	1/1990
DE	295 06 480 U1	8/1995
DE	296 13 916 U1	1/1998
DE	4 01 05 710.0	10/2001
EP	0 210 484 A2	2/1985
EP	0 210 484 Z2	2/1985
EP	0 151 086 A2	8/1985
EP	0 277 026 A2	8/1988
EP	0 291 821 A1	11/1988
EP	0 528 335 A1	2/1993
FR	2 750 851 A1	1/1998
FR	2 757 372 A1	6/1998
FR	2 770 994	5/1999
FR	653652	2/2002
FR	653653	2/2002
FR	653654	2/2002
FR	653655	2/2002
FR	653656	2/2002
FR	653657	2/2002
FR	653658	2/2002
FR	653659	2/2002
FR	653660	2/2002
FR	653661	2/2002
FR	653662	2/2002
FR	653663	2/2002
FR	653664	2/2002
GB	866118	4/1961
GB	886118	1/1962
GB	2102229 A	1/1983
GB	2105427	3/1983
GB	1014814	2/1984
GB	1053786	4/1989
GB	2075293	9/1998
GB	2101077	4/2001
JP	58-147508	10/1983
WO	WO 88/10101	12/1988
WO	WO 97/16130	5/1997
WO	WO 01/01881 A2	1/2001

* cited by examiner

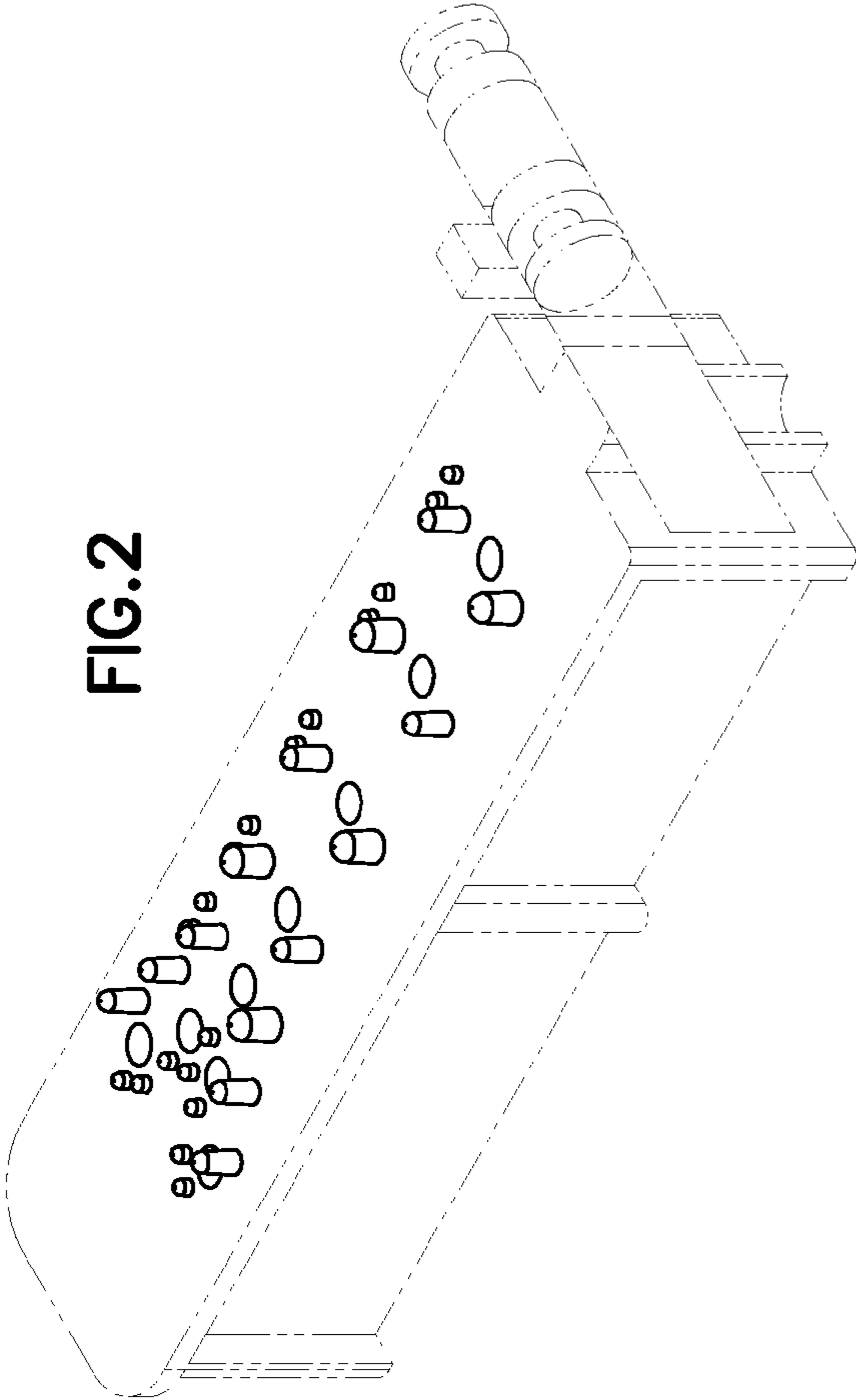
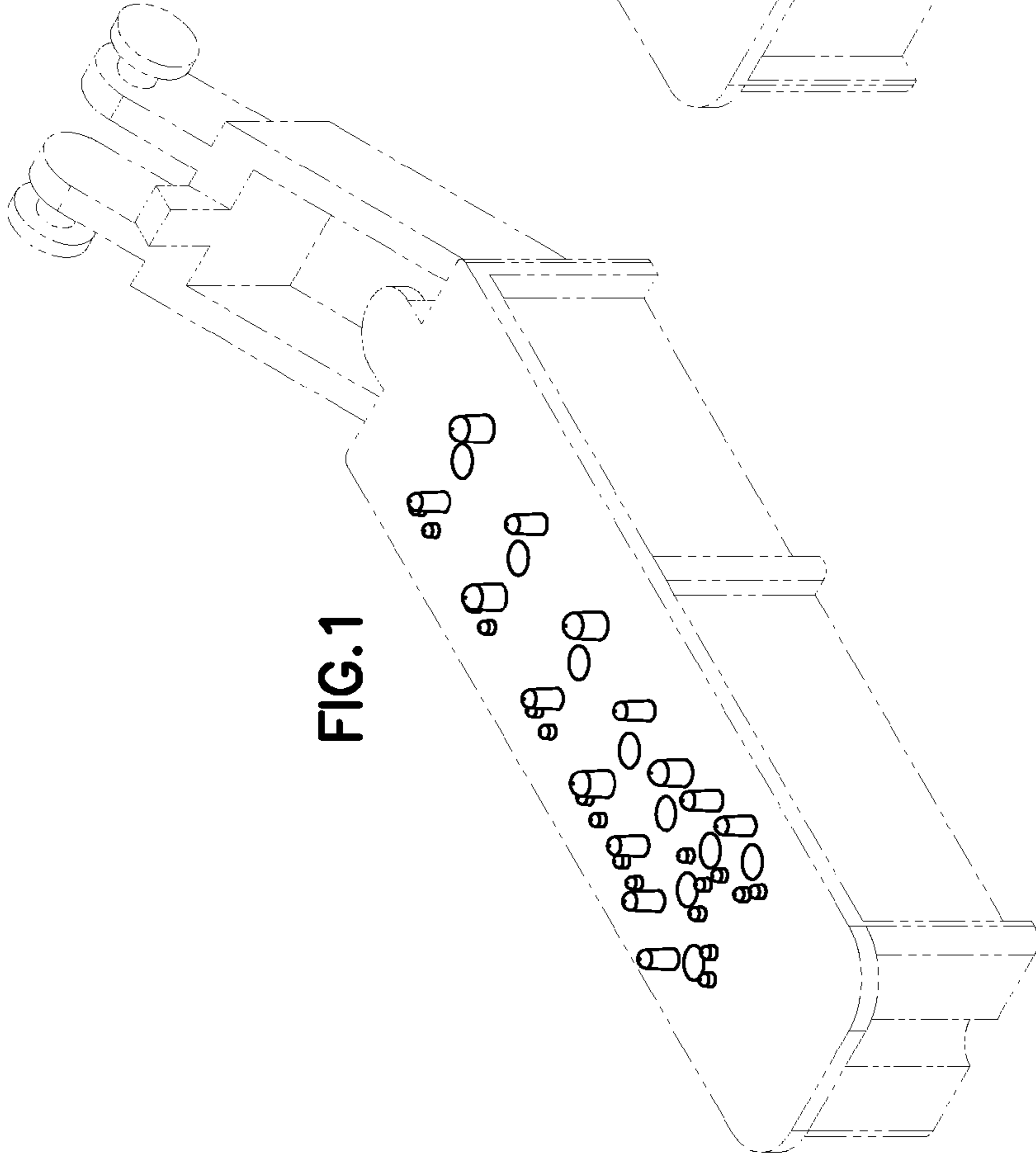

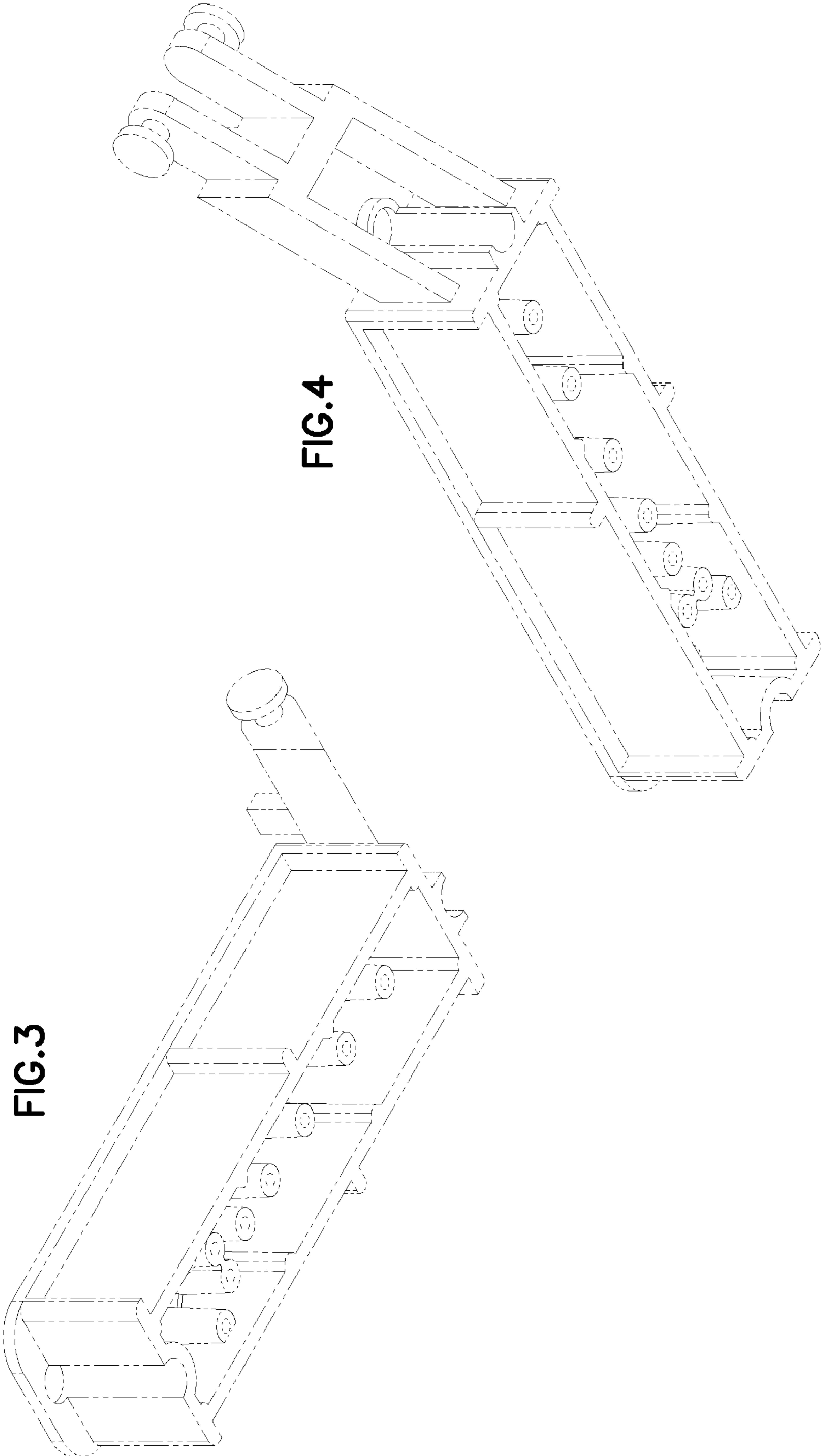

FIG.3

FIG.4

FIG.5

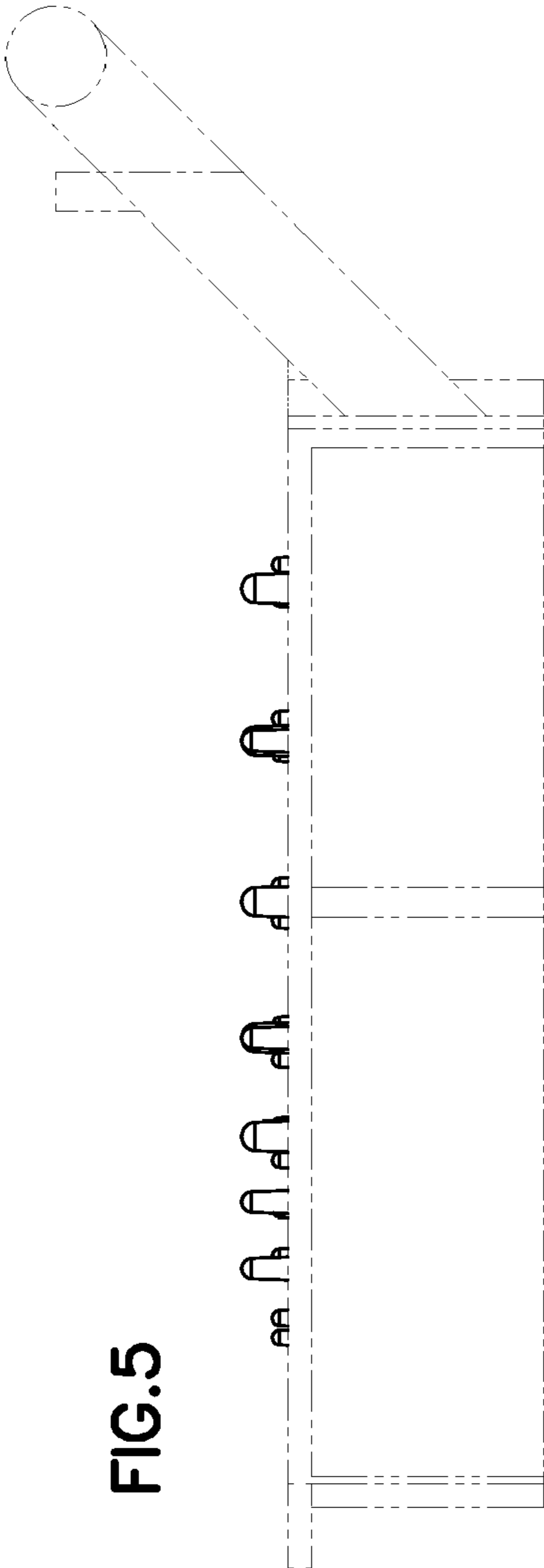

FIG.6

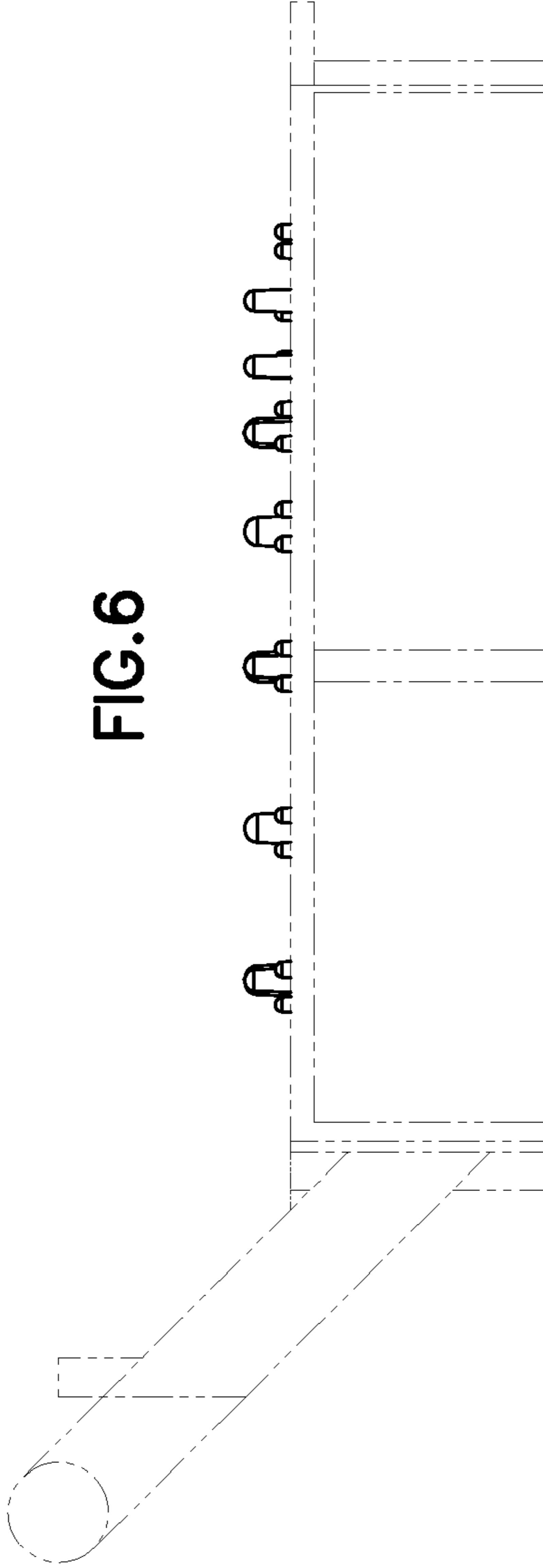

FIG.8

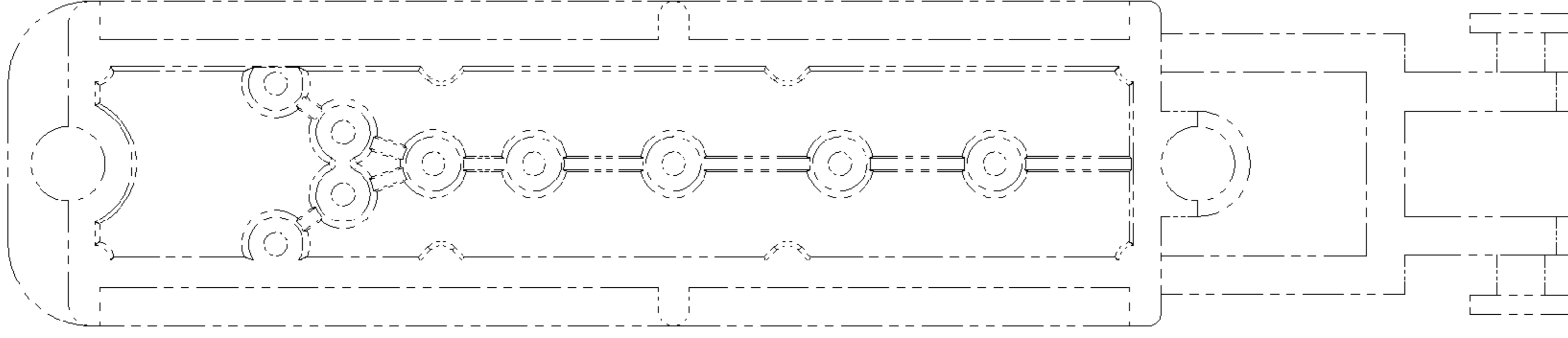

FIG.10

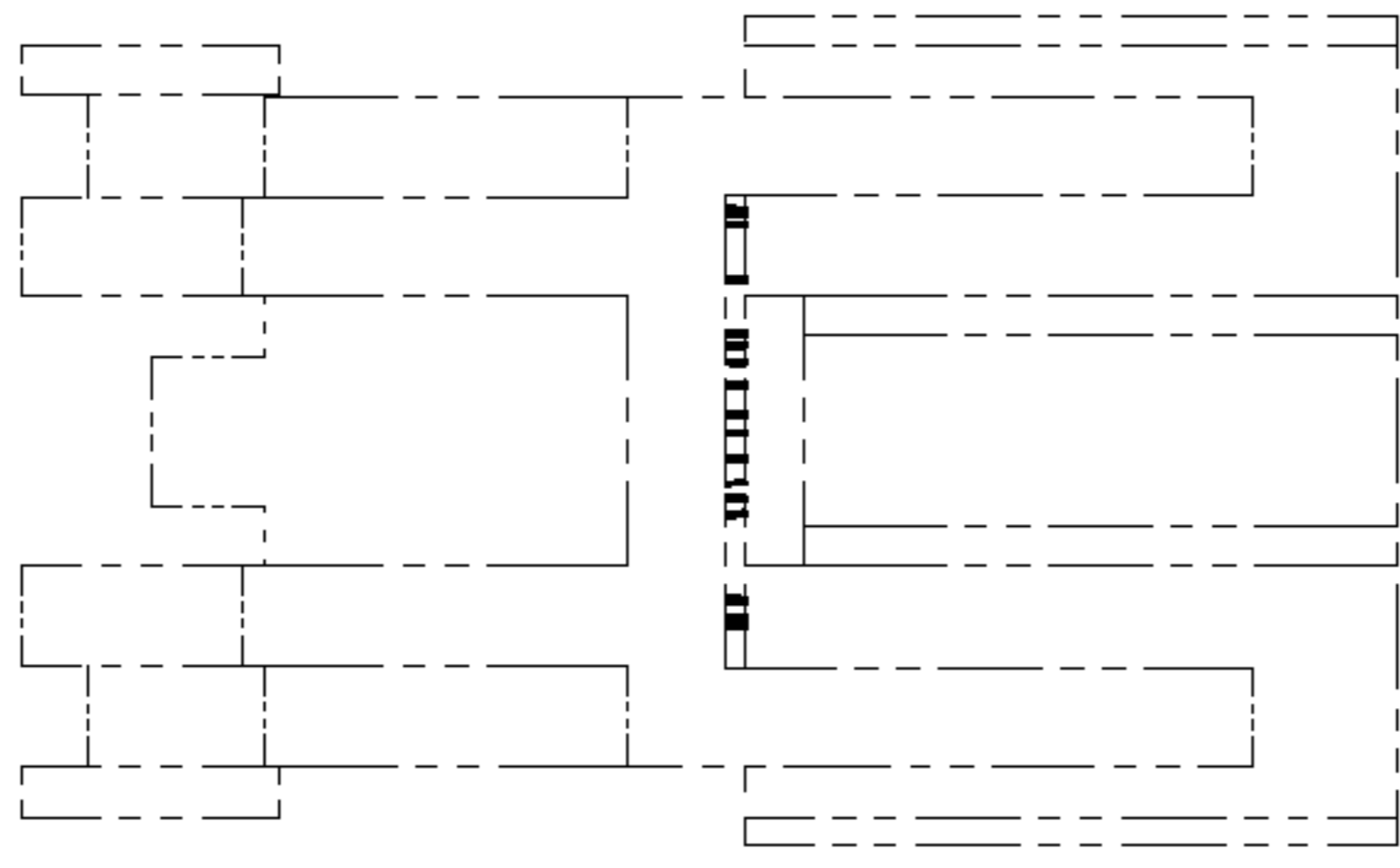

FIG.9

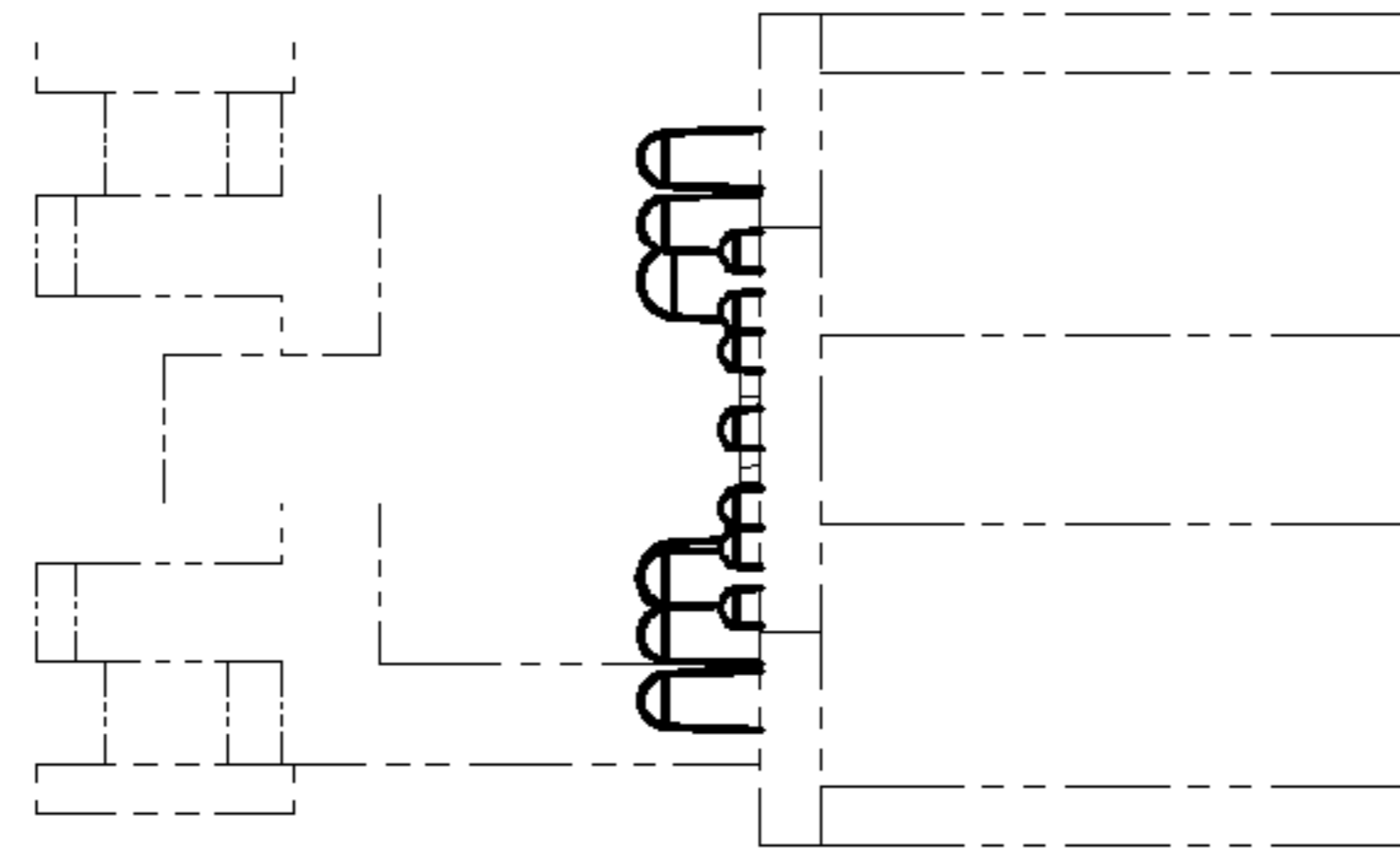

FIG.7

