

US00D594931S

(12) **United States Design Patent**  
**Miyazoe**

(10) **Patent No.:** **US D594,931 S**  
(45) **Date of Patent:** **\*\* Jun. 23, 2009**

(54) **ELECTROMAGNETIC VALVE**

(75) Inventor: **Shinji Miyazoe**, Tsukubamirai (JP)

(73) Assignee: **SMC Corporation**, Chiyoda-ku, Tokyo (JP)

(\*\*) Term: **14 Years**

(21) Appl. No.: **29/293,737**

(22) Filed: **Dec. 10, 2007**

(30) **Foreign Application Priority Data**

Jun. 11, 2007 (JP) ..... 2007-015451

(51) **LOC (9) Cl.** ..... **23-01**

(52) **U.S. Cl.** ..... **D23/233**

(58) **Field of Classification Search** ..... D23/233-237,  
D23/244-249; D15/5, 7, 199; 137/554,  
137/557, 560, 882, 884, 269, 271, 343, 625.64;  
251/596.13, 596.16, 331, 219, 15, 130, 129.04  
See application file for complete search history.

(56) **References Cited**

**U.S. PATENT DOCUMENTS**

D414,545	S	*	9/1999	Hayashi et al.	.....	D23/233
D424,166	S	*	5/2000	Hayashi et al.	.....	D23/233
D428,111	S	*	7/2000	Hayashi et al.	.....	D23/233
D479,308	S	*	9/2003	Hayashi et al.	.....	D23/233
D479,738	S	*	9/2003	Hayashi et al.	.....	D23/233
D532,865	S	*	11/2006	Miyazoe et al.	.....	D23/233

D533,628	S	*	12/2006	Miyazoe et al.	.....	D23/233
D545,945	S	*	7/2007	Miyazoe	.....	D23/233
D563,507	S	*	3/2008	Kato et al.	.....	D23/233
D563,514	S	*	3/2008	Mita et al.	.....	D23/233
D563,516	S	*	3/2008	Mita et al.	.....	D23/233
D564,631	S	*	3/2008	Miyazoe et al.	.....	D23/233

\* cited by examiner

*Primary Examiner*—Joel Sincavage

*Assistant Examiner*—Maurice Stevens

(74) *Attorney, Agent, or Firm*—Yokoi & Co., U.S.A., Inc.;  
Peter Ganjian

(57) **CLAIM**

The ornamental design for an electromagnetic valve, as shown and described.

**DESCRIPTION**

FIG. 1 shows a front view of an electromagnetic valve showing my new design;

FIG. 2 shows a rear view thereof;

FIG. 3 shows a top view thereof;

FIG. 4 shows a bottom view thereof;

FIG. 5 shows a left side view thereof;

FIG. 6 shows a right side view thereof;

FIG. 7 shows a bottom, front and right side perspective view thereof; and,

FIG. 8 shows a top, rear and left side perspective view thereof.

**1 Claim, 7 Drawing Sheets**

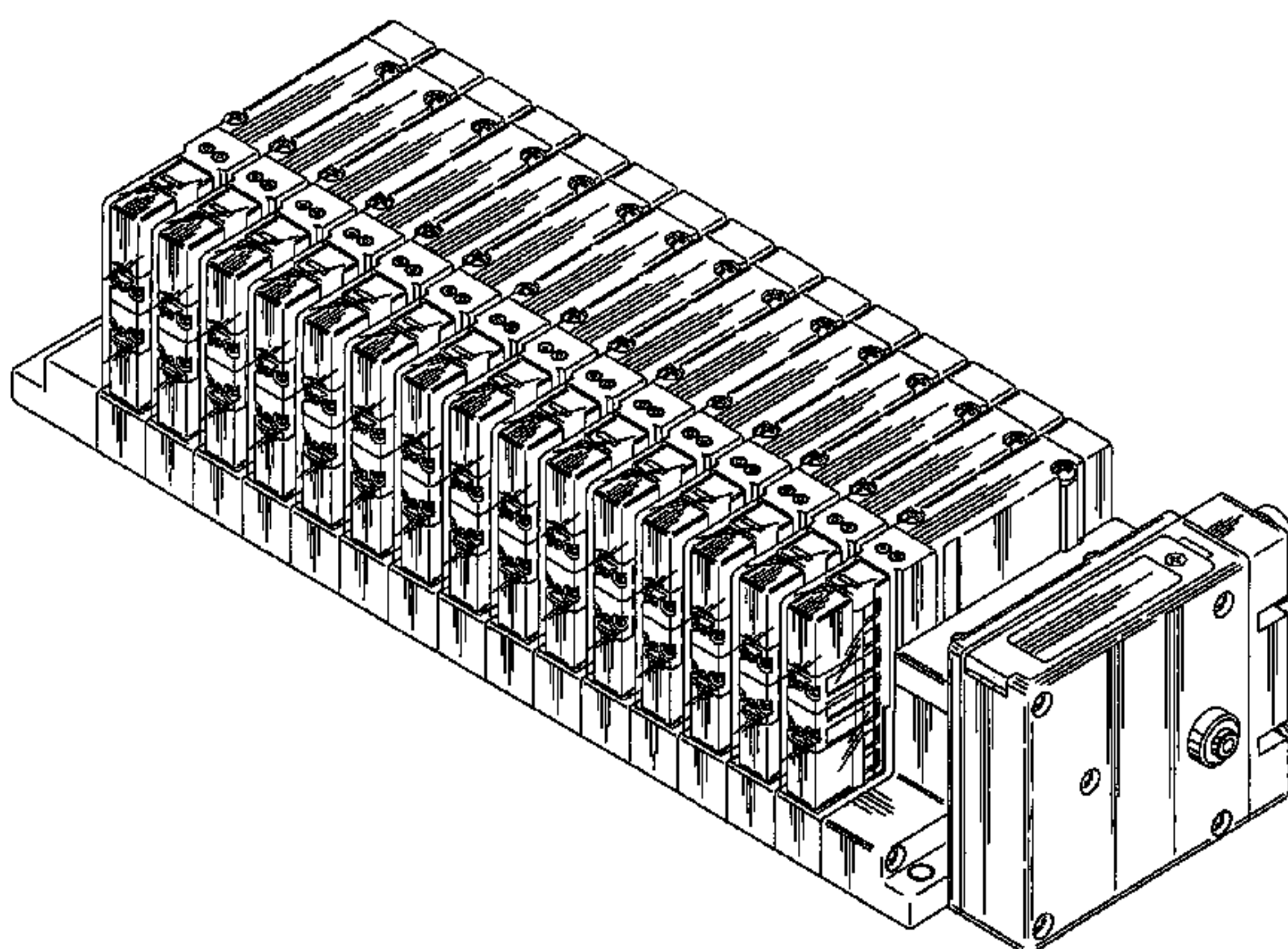
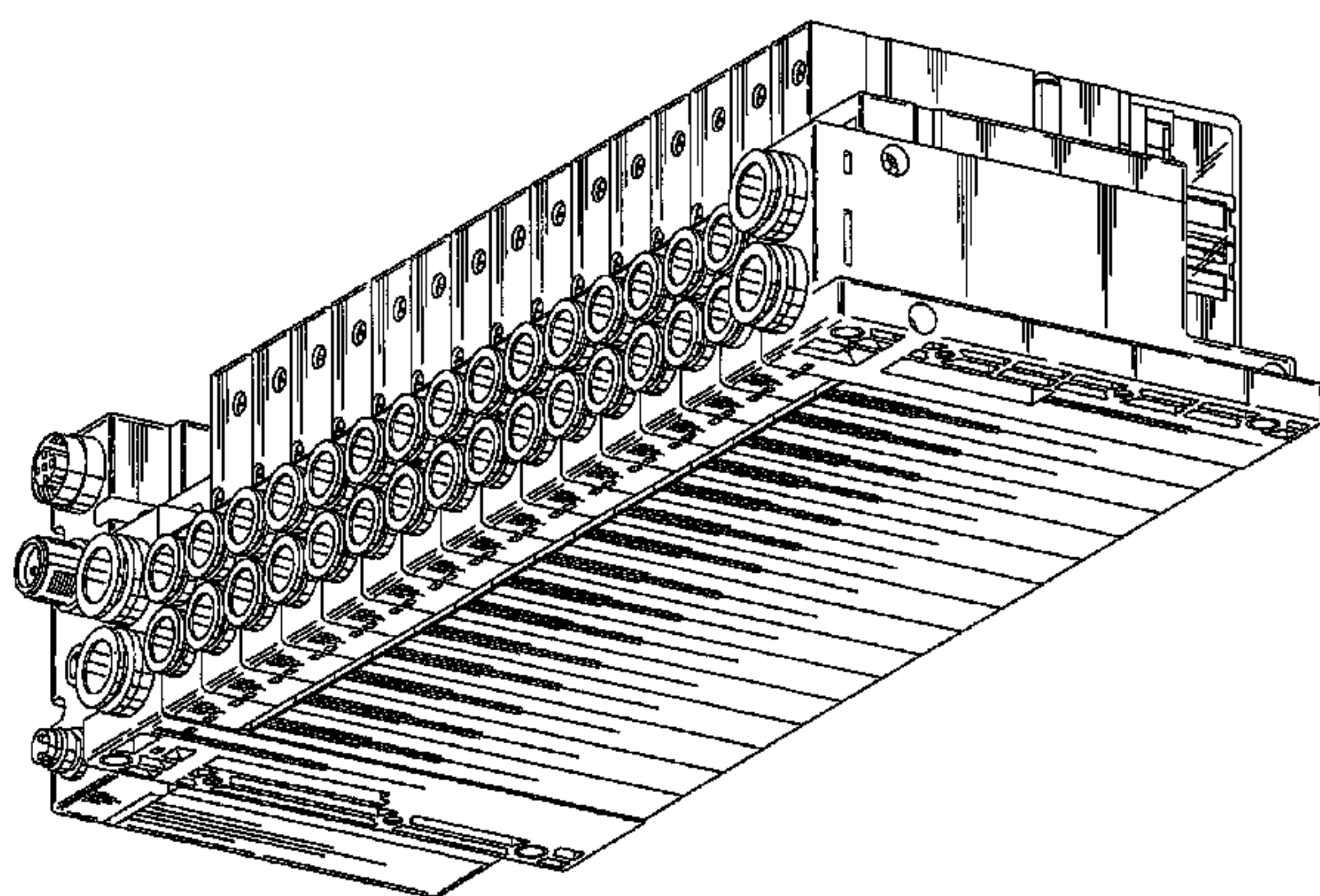

FIG. 1

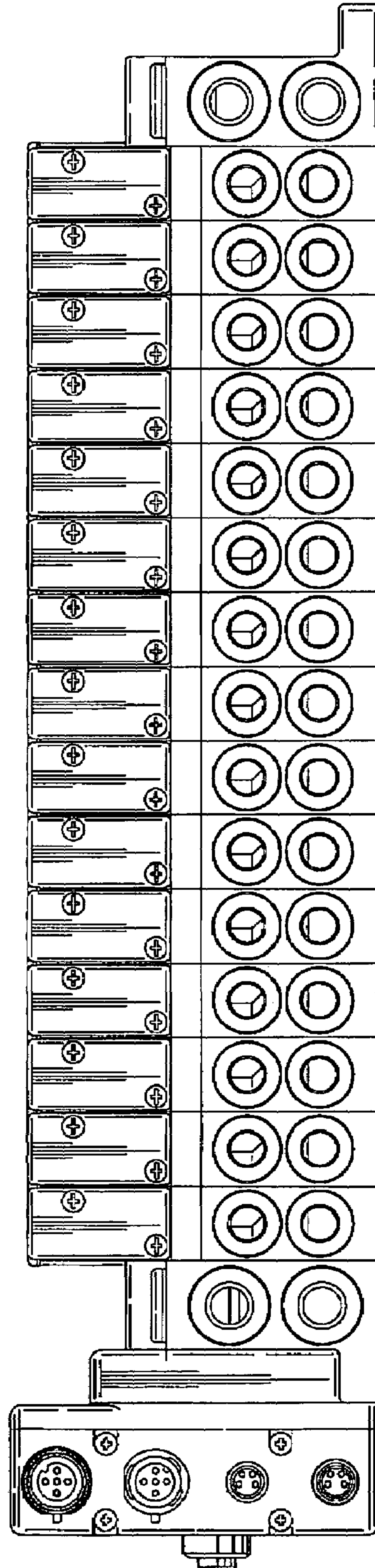

FIG. 2

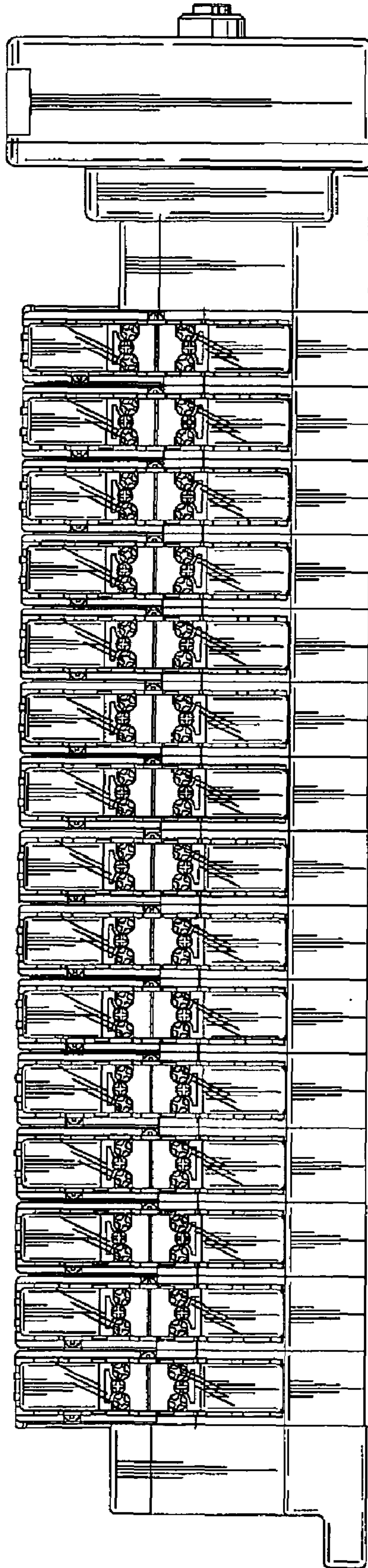



FIG. 3

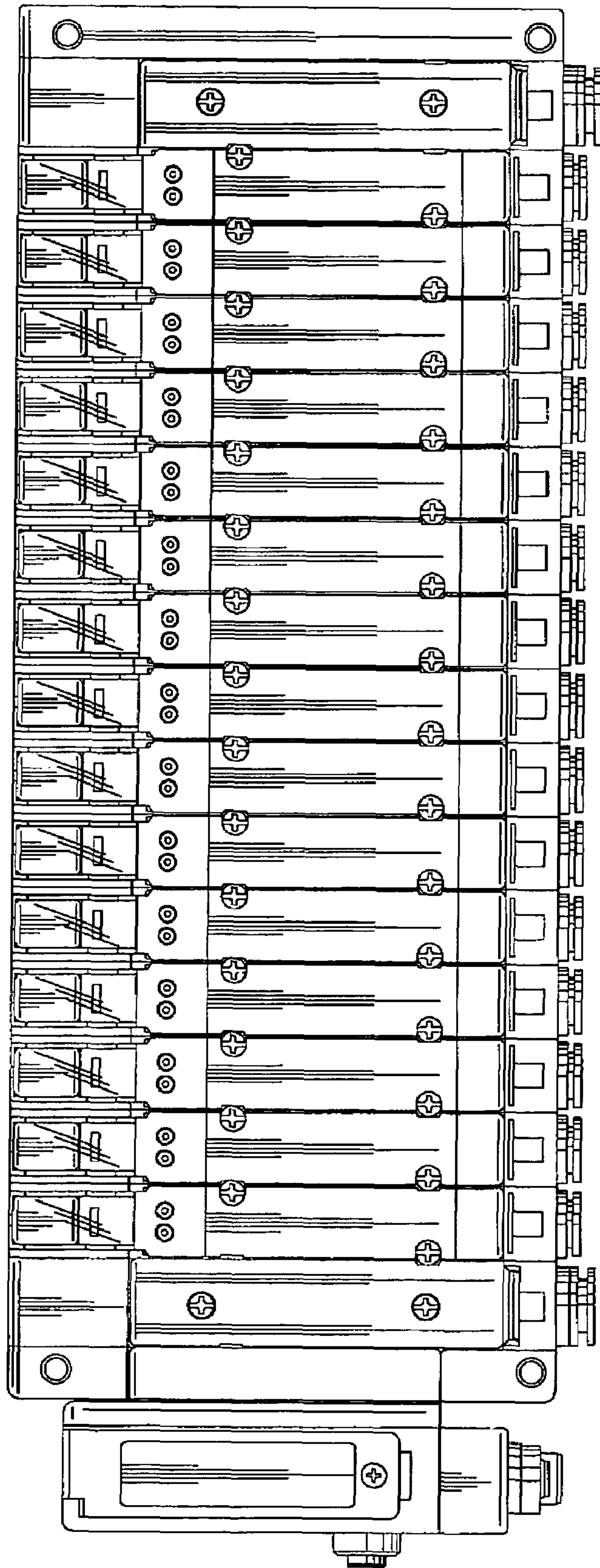

FIG. 4

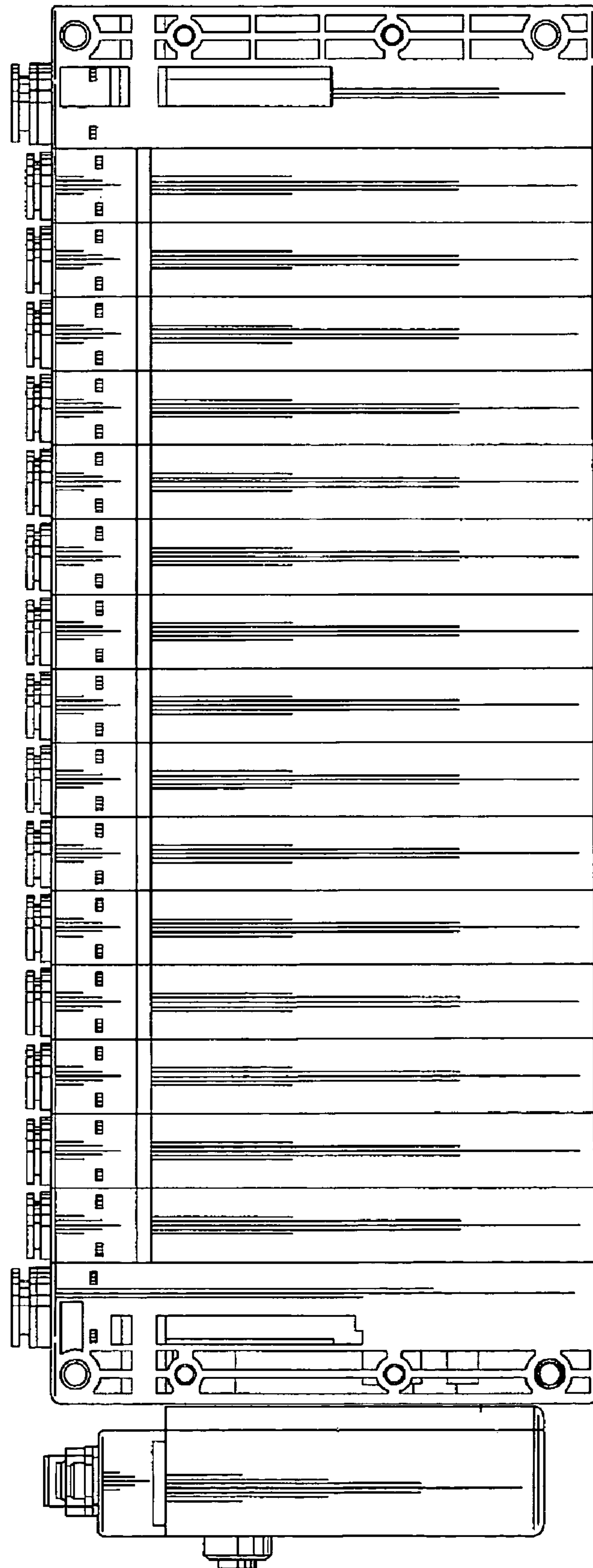

FIG. 5

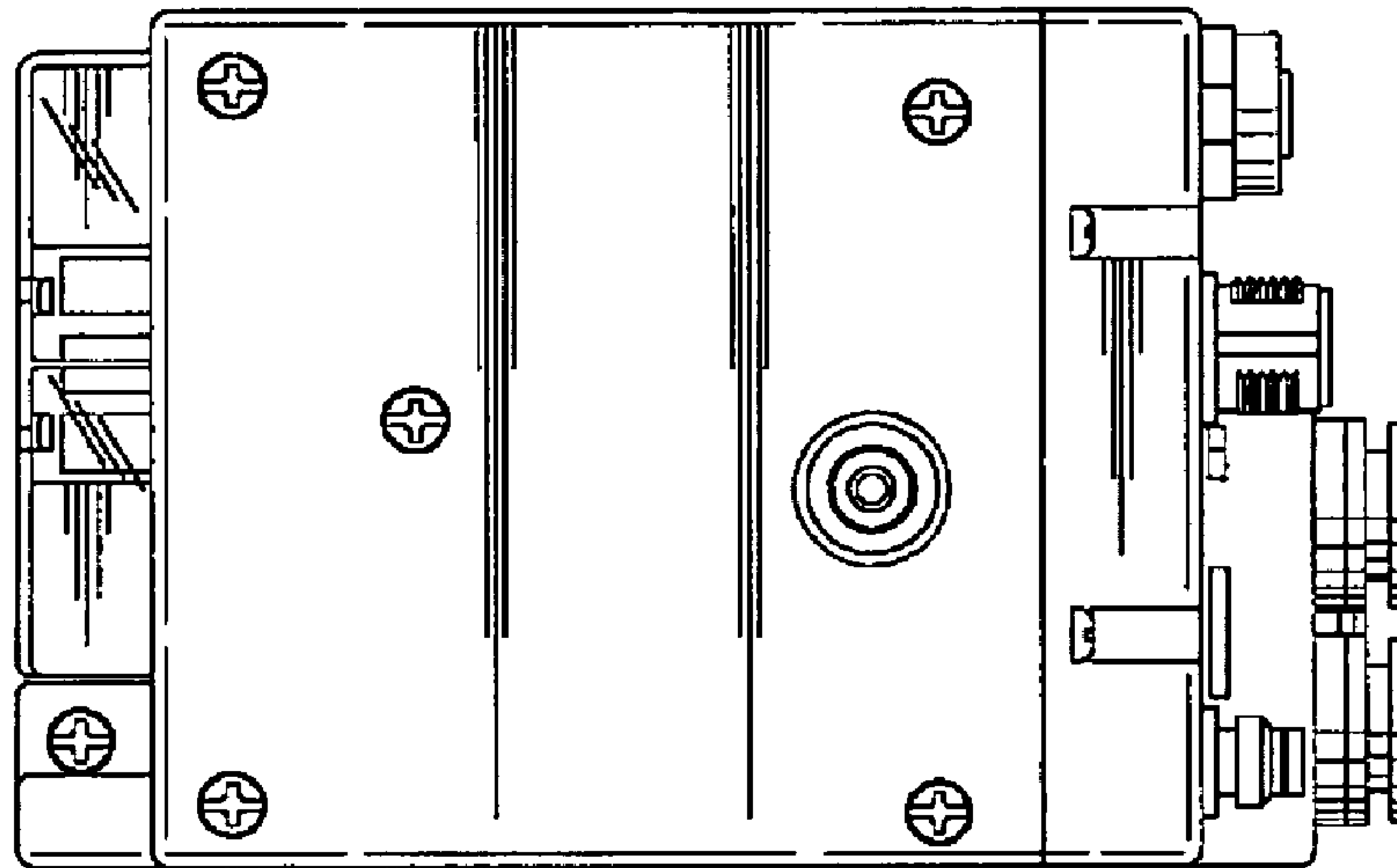
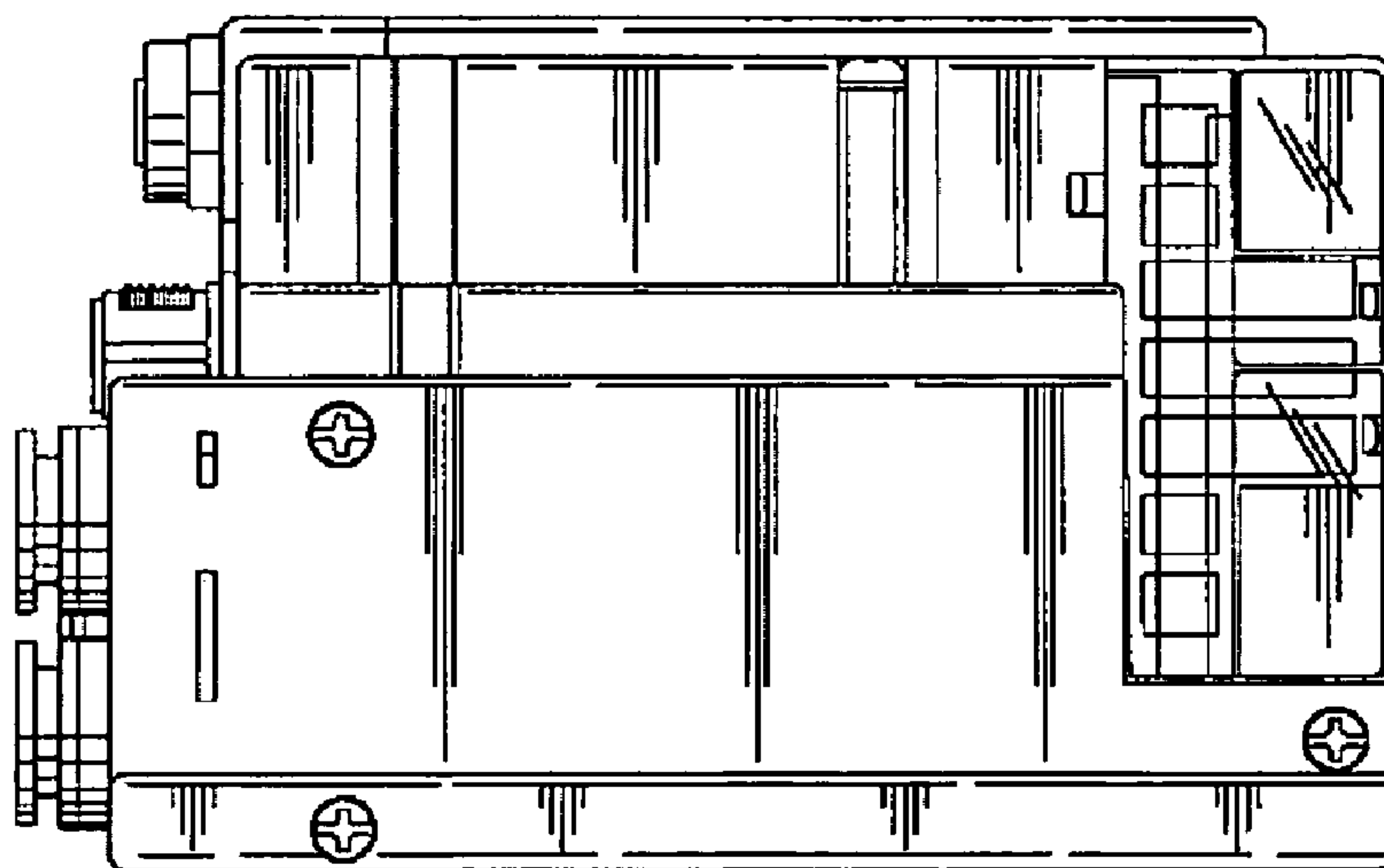

FIG. 6



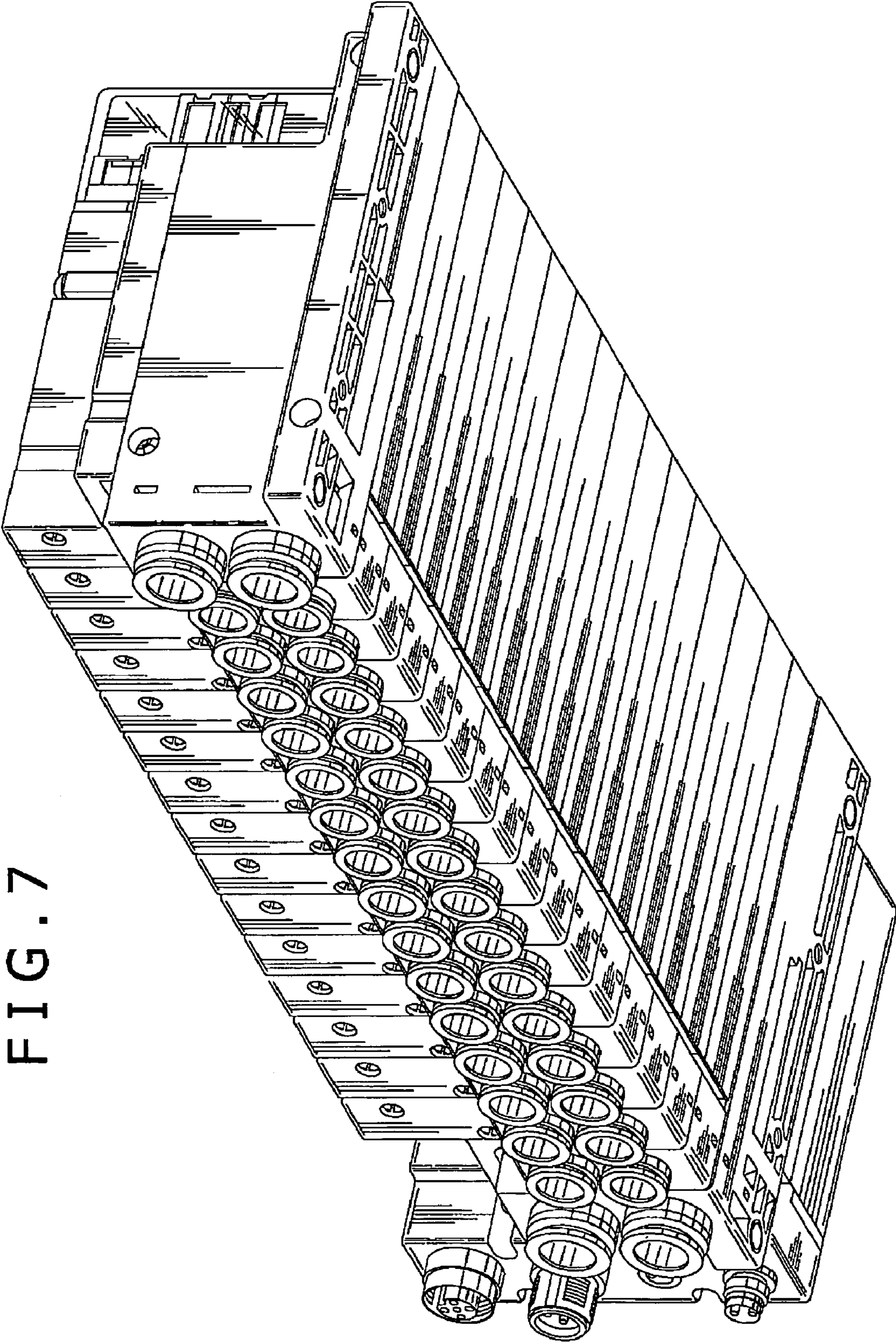

FIG. 7



FIG. 8

