



US00D594840S

(12) **United States Design Patent**
Kim et al.

(10) **Patent No.:** **US D594,840 S**
(45) **Date of Patent:** **** Jun. 23, 2009**

(54) **PORTABLE PHONE**

(75) Inventors: **Bo-Ra Kim**, Seoul (KR); **Seung-Min Park**, Seoul (KR); **Chang-Hwan Hwang**, Goyang-Si (KR)

(73) Assignee: **Samsung Electronics Co., Ltd.**, Suwon-Si (KR)

(**) Term: **14 Years**

(21) Appl. No.: **29/322,672**

(22) Filed: **Aug. 8, 2008**

(30) **Foreign Application Priority Data**

Feb. 15, 2008 (KR) 30-2008-0006504

(51) **LOC (9) Cl.** **14-03**

(52) **U.S. Cl.** **D14/138 G; D14/138 AD**

(58) **Field of Classification Search** D14/137, D14/138 R, 138 AA, 138 AB, 138 AC, 138 AD, D14/138 C, 138 G, 147, 191, 203.1–203.8, D14/218, 247–248, 341–347, 432, 439, 455–456, D14/496; D10/65, 78, 104; D13/168; D18/7; 455/556.1, 566, 575.1, 575.3; 345/169

See application file for complete search history.

(56) **References Cited**

U.S. PATENT DOCUMENTS

6,625,283	B1 *	9/2003	Sato	379/433.07
D506,937	S *	7/2005	Lee et al.	D10/65
D546,805	S *	7/2007	Kim et al.	D14/138 AA
D557,238	S *	12/2007	Kim	D14/138 AD
D558,758	S *	1/2008	Andre et al.	D14/341
D569,837	S *	5/2008	Baik et al.	D14/138 G
D573,143	S *	7/2008	Park et al.	D14/341
D575,259	S *	8/2008	Kim et al.	D14/138 AD
D575,760	S *	8/2008	Kim et al.	D14/138 G
D577,353	S *	9/2008	Kim et al.	D14/138 AD
D577,703	S *	9/2008	Lee et al.	D14/138 G
D577,704	S *	9/2008	Park et al.	D14/138 AD
D578,099	S *	10/2008	Park et al.	D14/138 AD
D579,902	S *	11/2008	Kim et al.	D14/138 R
D579,904	S *	11/2008	Kim et al.	D14/138 R
D579,906	S *	11/2008	Kim et al.	D14/138 R
D580,393	S *	11/2008	Kim et al.	D14/138 R
D581,384	S *	11/2008	Kim et al.	D14/138 R

D583,342	S *	12/2008	Kim et al.	D14/138 G
D583,345	S *	12/2008	Kim et al.	D14/138 AD
D584,272	S *	1/2009	Chung et al.	D14/138 R
D584,711	S *	1/2009	Kim et al.	D14/138 G
D584,738	S *	1/2009	Kim et al.	D14/496
2007/0265031	A1 *	11/2007	Koizumi et al.	455/556.1
2007/0287512	A1 *	12/2007	Kilpi et al.	455/575.1
2008/0051161	A1 *	2/2008	Tashiro	455/575.1

OTHER PUBLICATIONS

LG KF700, announced Feb. 2008, [online], [retrieved on Mar. 21, 2008 and May 14, 2008]. Retrieved from Internet ,<URL: http://www.gsmarena.com>.*

Samsung F490, announced Jan. 2008, [online], [retrieved on Jan. 18, 2008]. Retrieved from Internet ,<URL: http://www.gsmarena.com>.*

* cited by examiner

Primary Examiner—Jeffrey D Asch

Assistant Examiner—Bridget L Eland

(74) *Attorney, Agent, or Firm*—Staas & Halsey LLP

(57) **CLAIM**

The ornamental design for a portable phone, as shown and described.

DESCRIPTION

FIG. 1 is a perspective view of a portable phone;
FIG. 2 is a front view of the portable phone of FIG. 1;
FIG. 3 is a rear view of the portable phone of FIG. 1;
FIG. 4 is a left-side view of the portable phone of FIG. 1;
FIG. 5 is a right-side view of the portable phone of FIG. 1;
FIG. 6 is a top plan view of the portable phone of FIG. 1;
FIG. 7 is a bottom plan view of the portable phone of FIG. 1;
FIG. 8 is a front open view of the portable phone of FIG. 1;
FIG. 9 is an open perspective view of the portable phone of FIG. 1; and,
FIG. 10 is a right-side open view of FIG. 8 of the portable phone of FIG. 1.

1 Claim, 8 Drawing Sheets

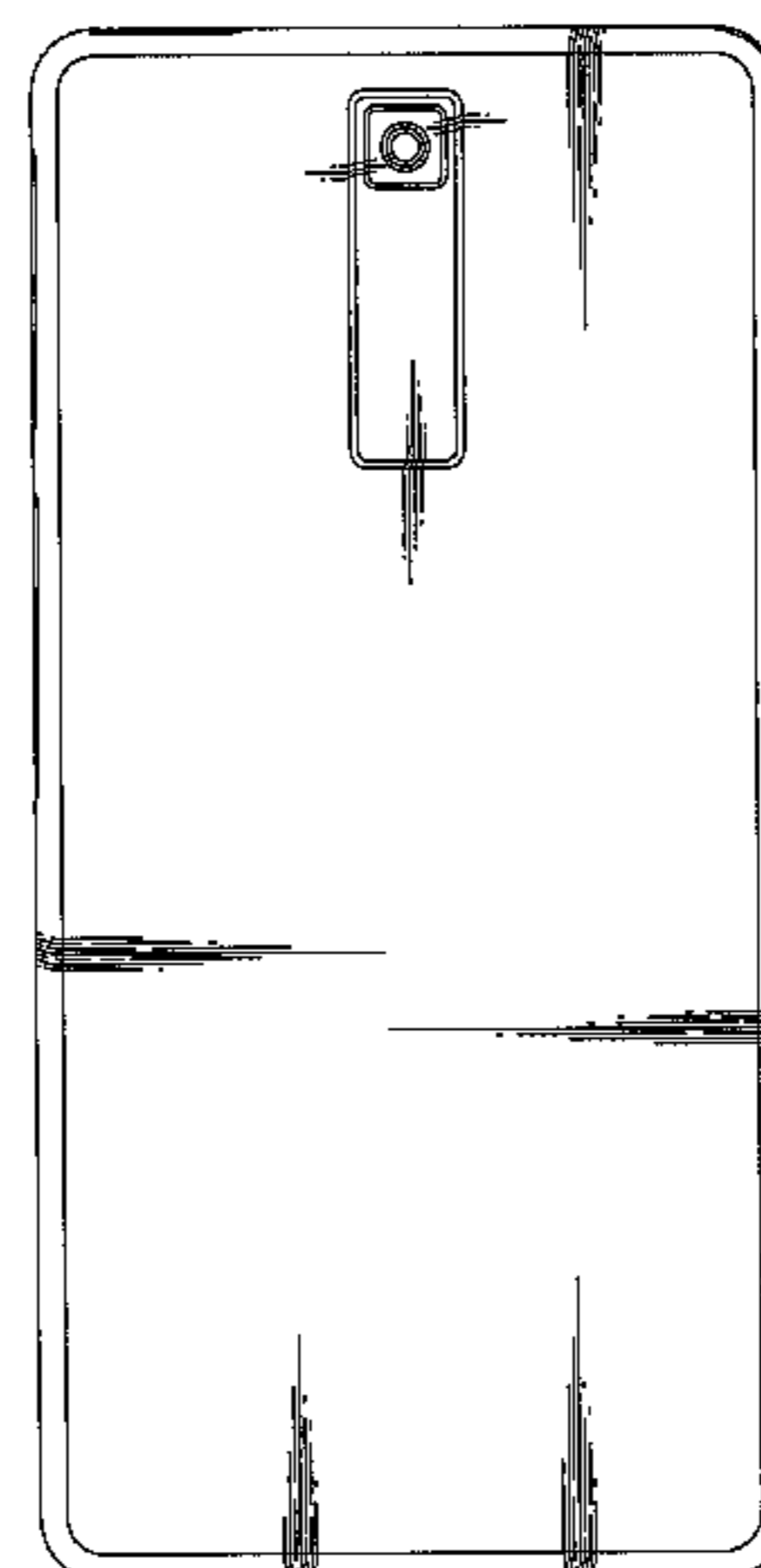
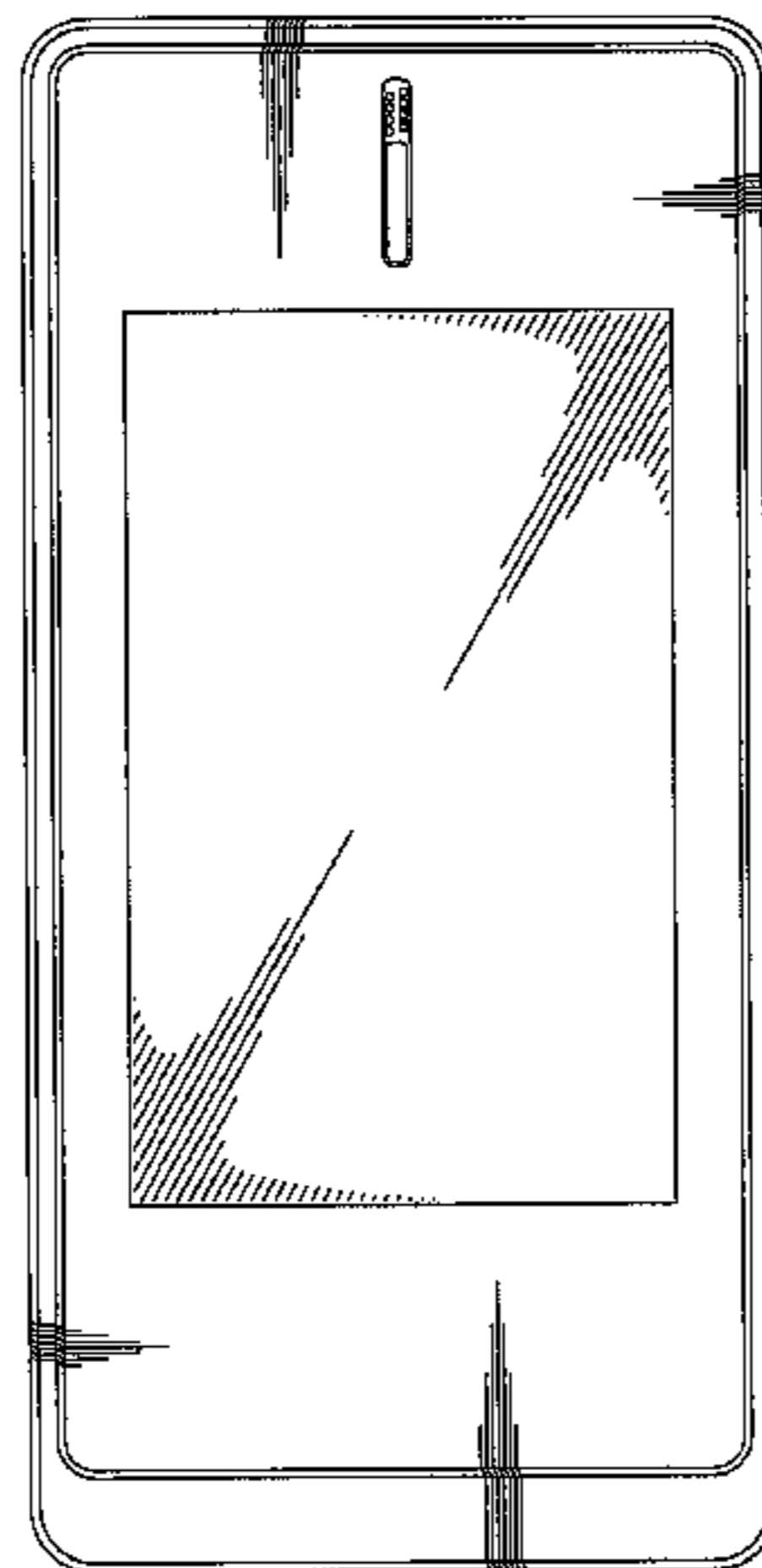

FIG. 1

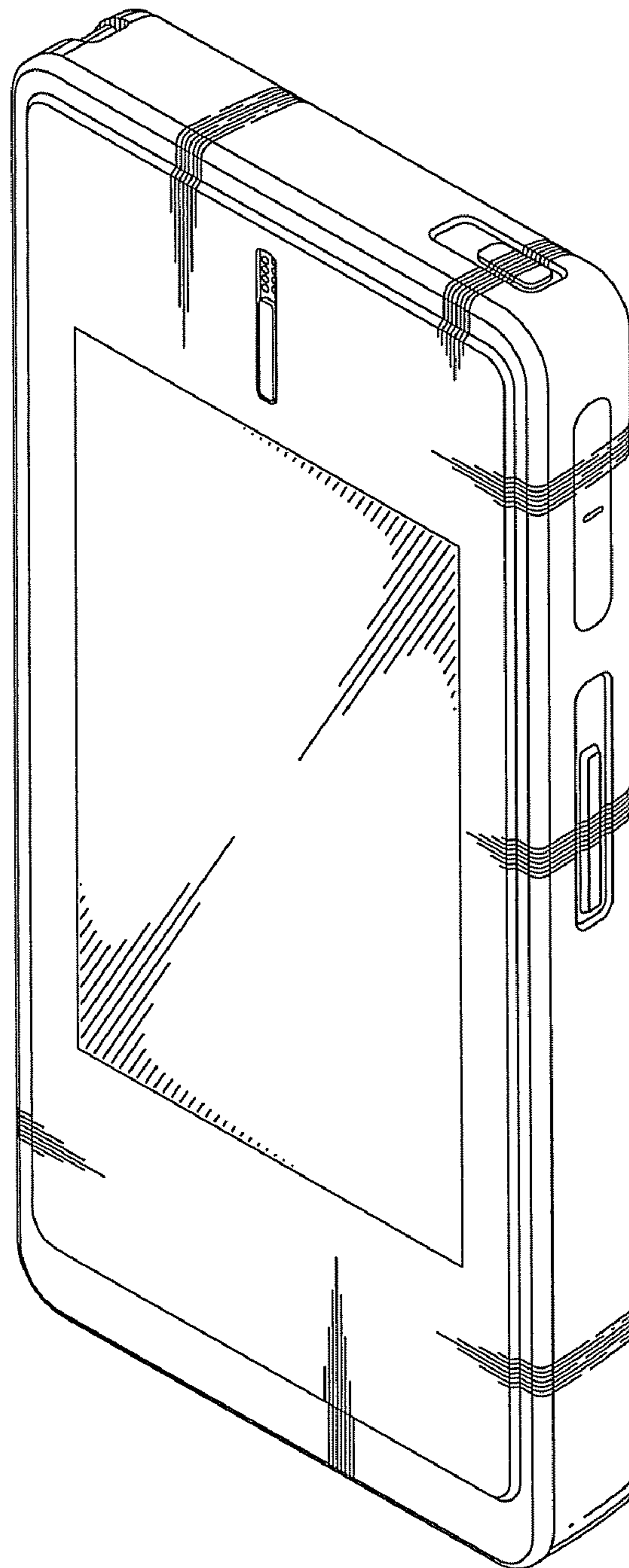

FIG. 2

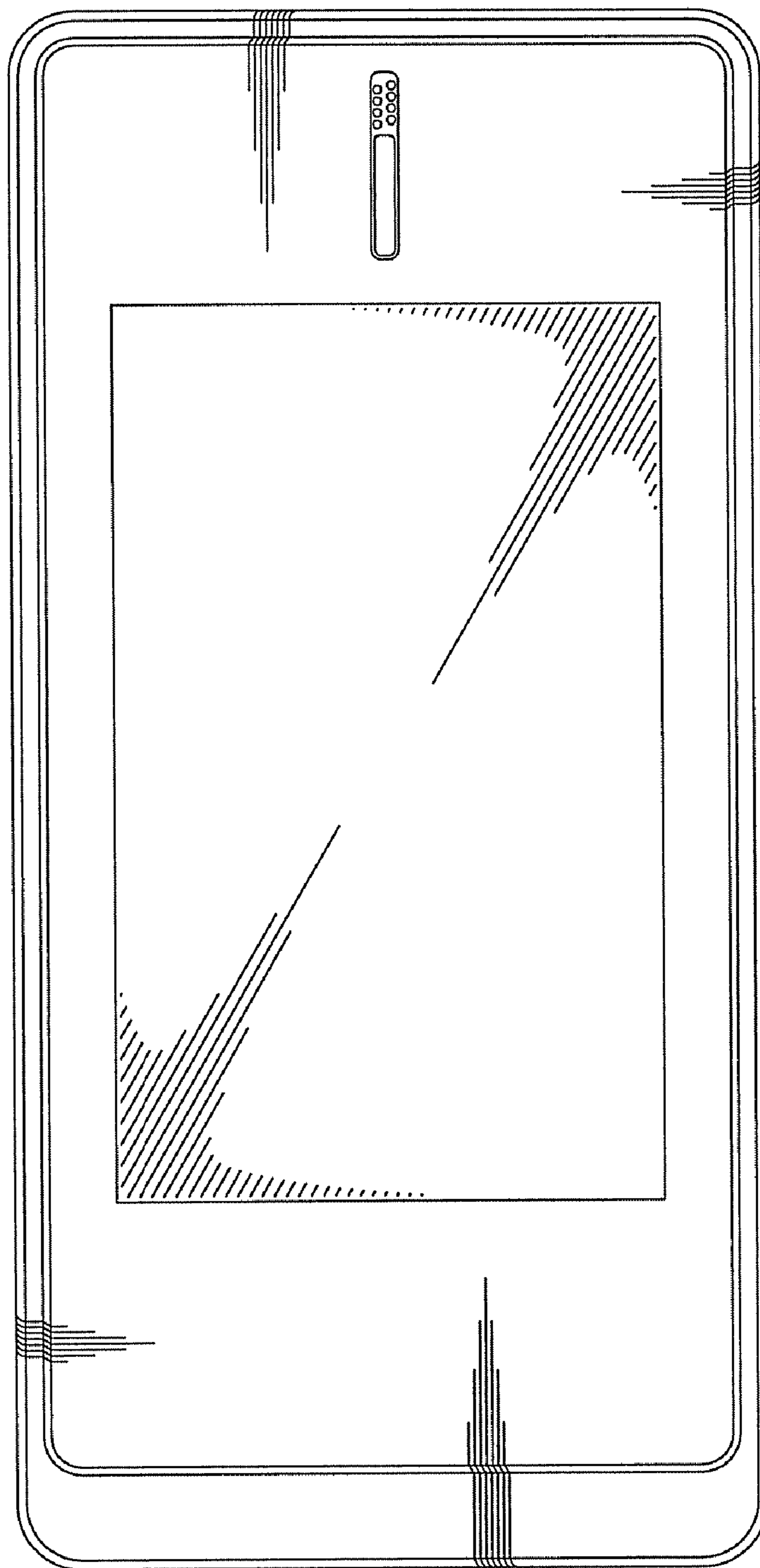

FIG. 3

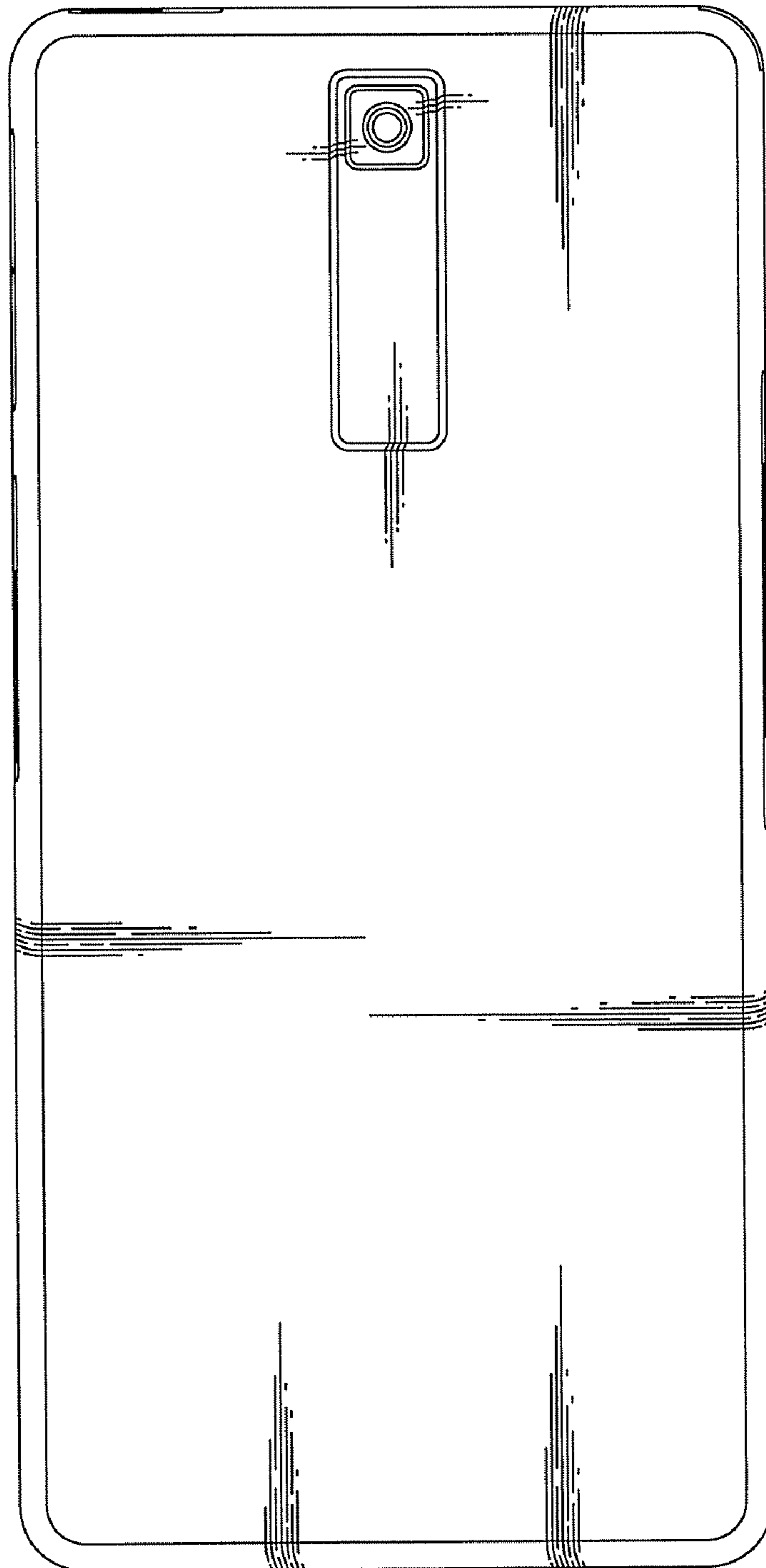

FIG. 4

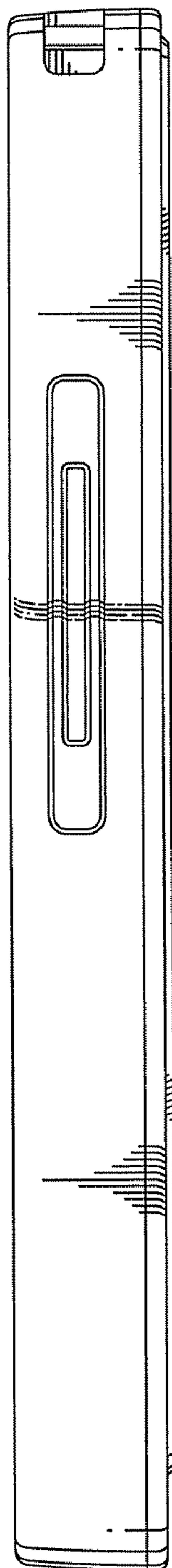

FIG. 5

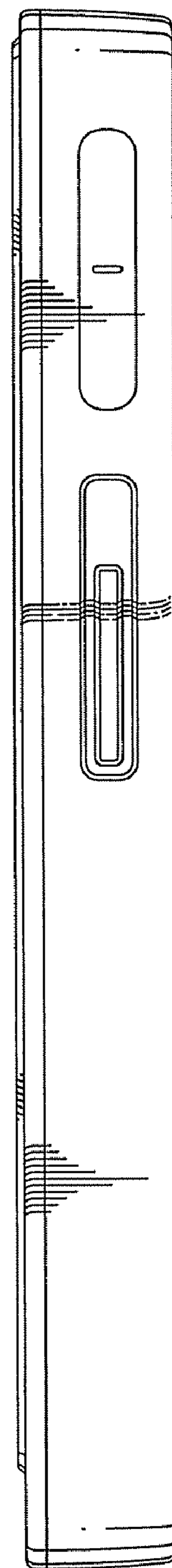

FIG. 6

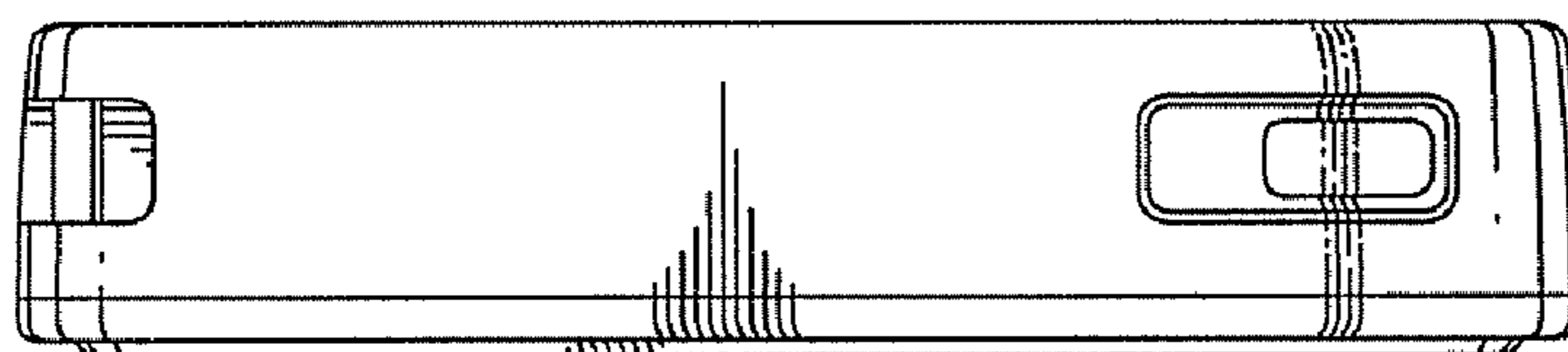

FIG. 7

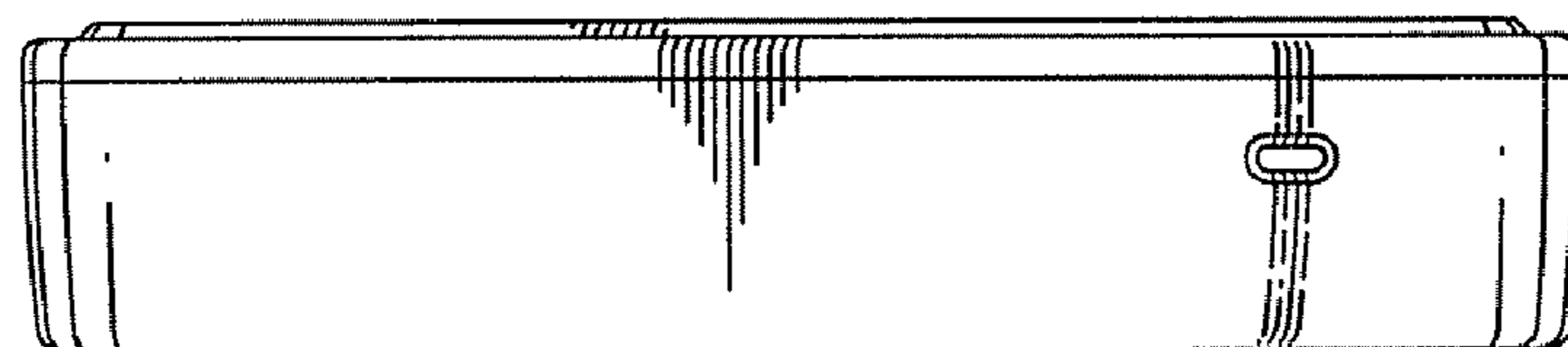

FIG. 8

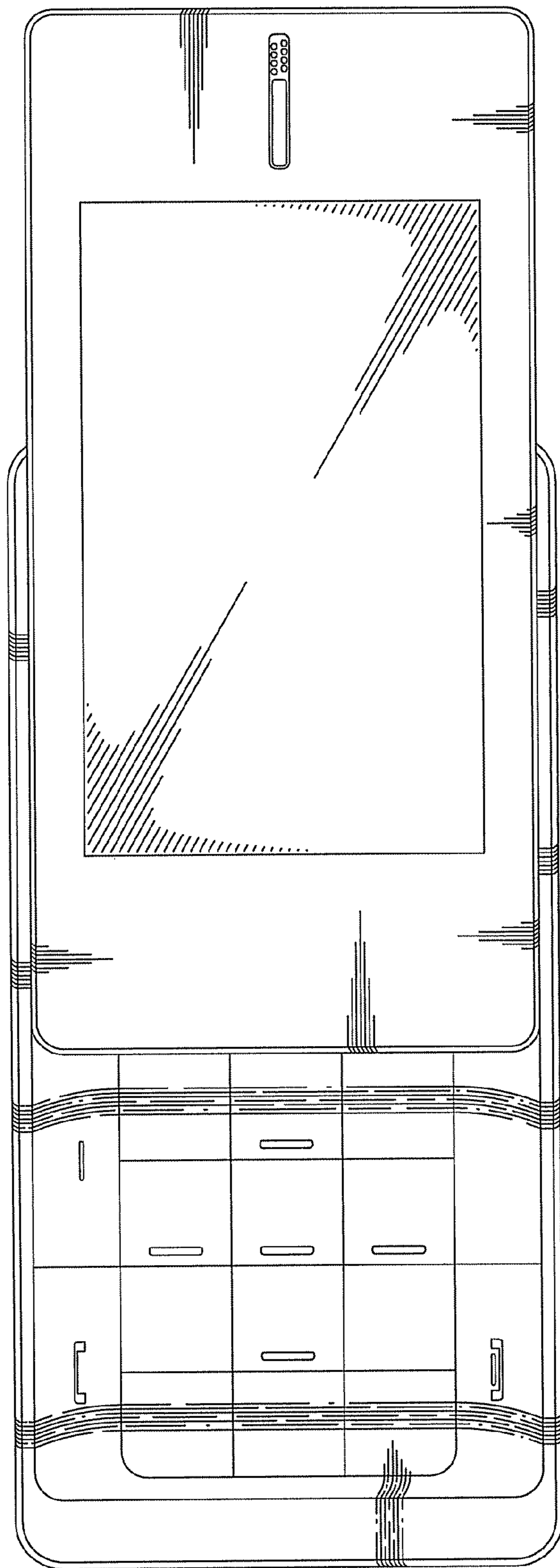

FIG. 9

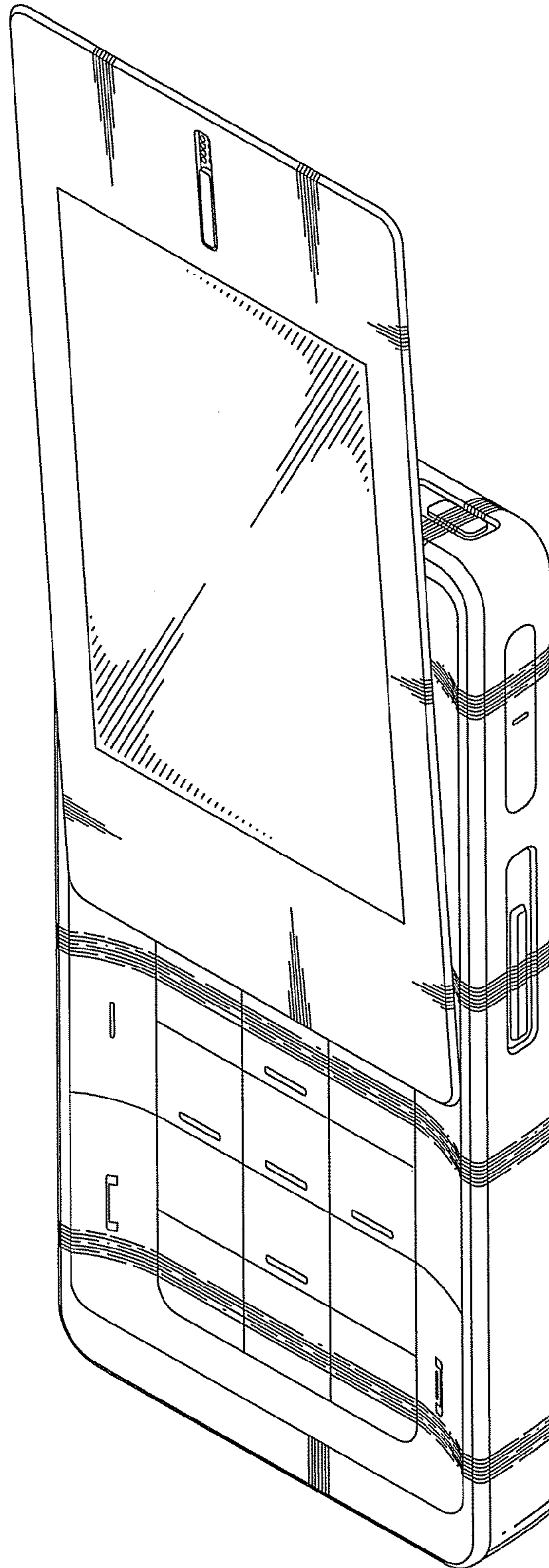

FIG. 10

