



US00D594838S

(12) **United States Design Patent**
Choi et al.

(10) **Patent No.:** **US D594,838 S**
(45) **Date of Patent:** **** Jun. 23, 2009**

(54) **MOBILE PHONE**

D576,989 S * 9/2008 Lee et al. D14/138 AD

(75) Inventors: **Kwang-Ha Choi**, Seoul (KR);
Beom-Ku Han, Seoul (KR); **Chang-Soo Lee**, Incheon (KR)

(Continued)

(73) Assignee: **Samsung Electronics Co., Ltd.**,
Suwon-Si (KR)

OTHER PUBLICATIONS

(**) Term: **14 Years**

(21) Appl. No.: **29/322,393**

BenQ EL71 and/or BenQ-Siemens EL71, both announced Feb. 2006, [online], [retrieved on Dec. 13, 2007 and Feb. 16, 2007 respectively]. Retrieved from Internet ,<URL: <http://www.gsmarena.com>>.*
Eten glofiish X500, announced Oct. 2006, [online], [retrieved on Feb. 20, 2007]. Retrieved from Internet ,<URL: <http://www.gsmarena.com>>.*
LG KF600, announced Feb. 2008, [online], [retrieved on Mar. 21, 2008]. Retrieved from Internet ,<URL: <http://www.gsmarena.com>>.*
LG KC550, announced May 2008, [online], [retrieved on May 30, 2008]. Retrieved from Internet ,<URL: <http://www.gsmarena.com>>.*
Sagem my721z, announced Feb. 2008, [online], [retrieved on Mar. 21, 2008]. Retrieved from Internet ,<URL: <http://www.gsmarena.com>>.*

(22) Filed: **Aug. 4, 2008**

(30) **Foreign Application Priority Data**

May 6, 2008 (KR) 30-2008-0018918

(51) **LOC (9) Cl.** **14-03**

(52) **U.S. Cl.** **D14/138 AD**

(58) **Field of Classification Search** D14/137,
D14/138 R, 138 AA, 138 AB, 138 AC, 138 AD,
D14/138 C, 138 G, 147, 191, 203.1-203.8,
D14/218, 247-248, 341-347, 432, 439, 455-456,
D14/496; D10/65, 78, 104; D13/168; D18/7;
455/556.1, 566, 575.1, 575.3; 345/169
See application file for complete search history.

Primary Examiner—Jeffrey D Asch
Assistant Examiner—Bridget L Eland
(74) *Attorney, Agent, or Firm*—Staas & Halsey LLP

(56) **References Cited**

(57) **CLAIM**

The ornamental design for a mobile phone, as shown and described.

U.S. PATENT DOCUMENTS

DESCRIPTION

D496,645 S * 9/2004 Yoo et al. D14/138 G
D511,342 S * 11/2005 Chien D14/346
D525,609 S * 7/2006 Kim et al. D14/138 AB
D548,715 S * 8/2007 Lee et al. D14/138 AD
D551,201 S * 9/2007 Kim et al. D14/138 AD
D553,115 S * 10/2007 Suk et al. D14/138 AD
D553,599 S * 10/2007 Lee et al. D14/138 AC
D558,726 S * 1/2008 Wang et al. D14/138 AD
D560,192 S * 1/2008 Lee et al. D14/138 AD
D563,929 S * 3/2008 Park D14/138 AD
D572,699 S * 7/2008 Ahn et al. D14/138 G
D574,015 S * 7/2008 Masui D14/496
D574,806 S * 8/2008 Lee et al. D14/138 AD
D575,759 S * 8/2008 Park et al. D14/138 AD

FIG. 1 is a front perspective view of a mobile phone;
FIG. 2 is a front view of the mobile phone of FIG. 1;
FIG. 3 is a rear view of the mobile phone of FIG. 1;
FIG. 4 is a left-side view of the mobile phone of FIG. 1;
FIG. 5 is a right-side view of the mobile phone of FIG. 1;
FIG. 6 is a top plan view of the mobile phone of FIG. 1;
FIG. 7 is a bottom plan view of the mobile phone of FIG. 1;
and,
FIG. 8 is an open front perspective view of the portable phone of FIG. 1.

1 Claim, 5 Drawing Sheets

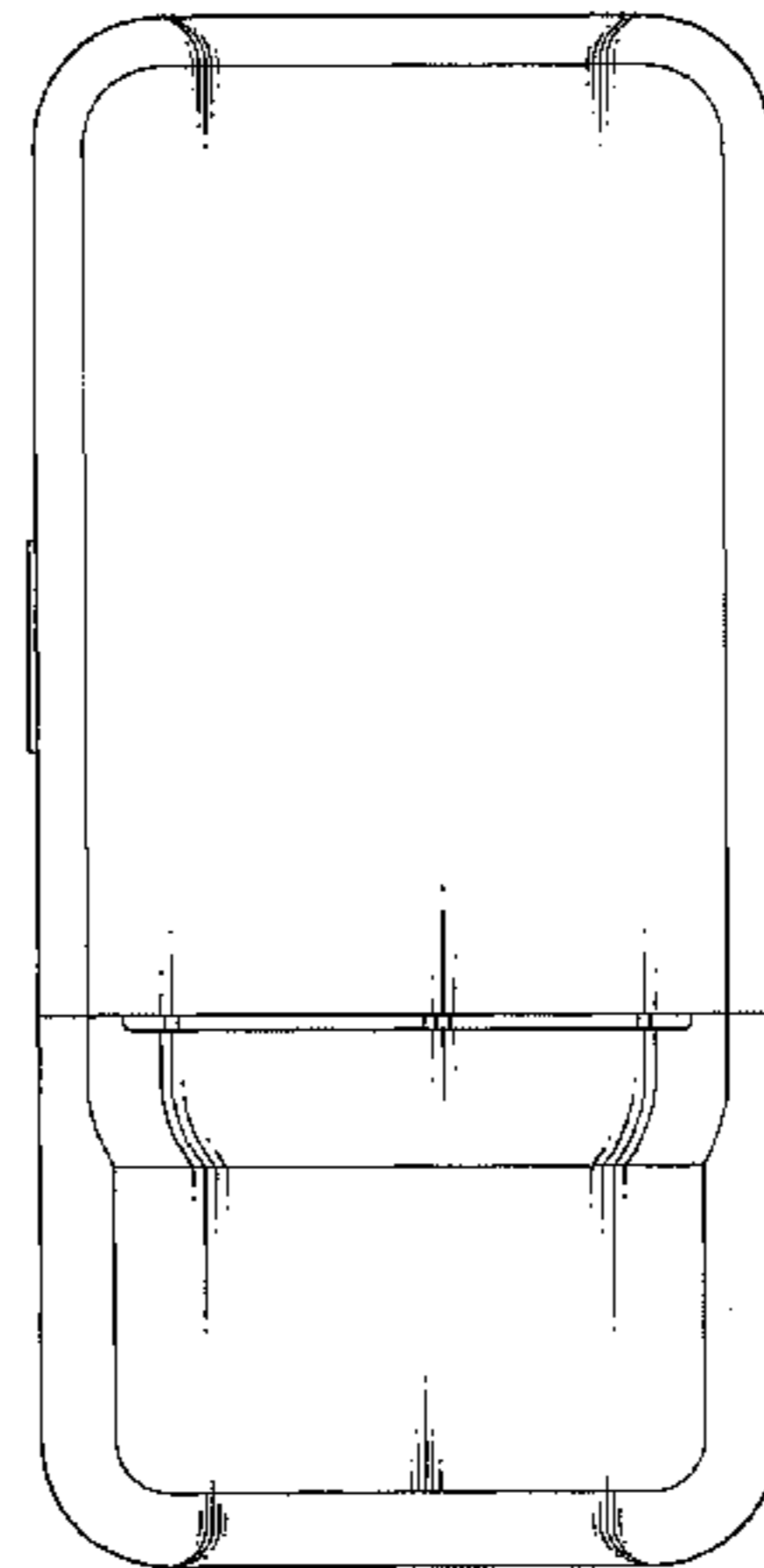
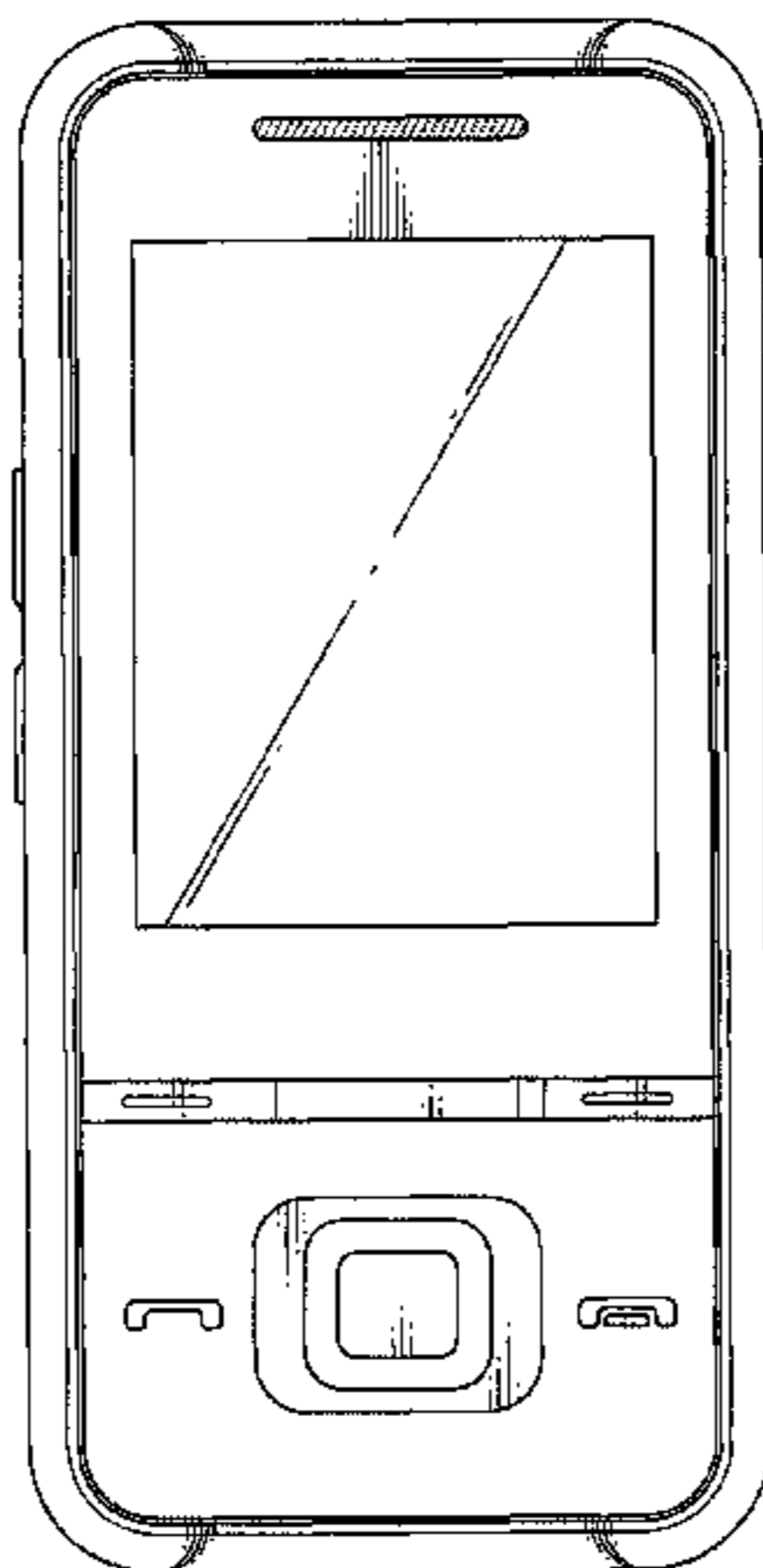

US D594,838 S

Page 2

U.S. PATENT DOCUMENTS

D576,996 S *	9/2008	Choe et al.	D14/138 AD	D581,387 S *	11/2008	Harju et al.	D14/138 R
D578,099 S *	10/2008	Park et al.	D14/138 AD	D583,346 S *	12/2008	Jung et al.	D14/138 AD
D579,439 S *	10/2008	Chung et al.	D14/138 R	2005/0255897 A1 *	11/2005	Lee et al.	455/575.4
D579,897 S *	11/2008	Kim et al.	D14/138 R	2007/0232243 A1 *	10/2007	Chen	455/90.3
D579,899 S *	11/2008	Park et al.	D14/138 R	2008/0070648 A1 *	3/2008	Kang et al.	455/575.3
				2008/0119248 A1 *	5/2008	Nissen et al.	455/575.4

* cited by examiner

FIG. 1

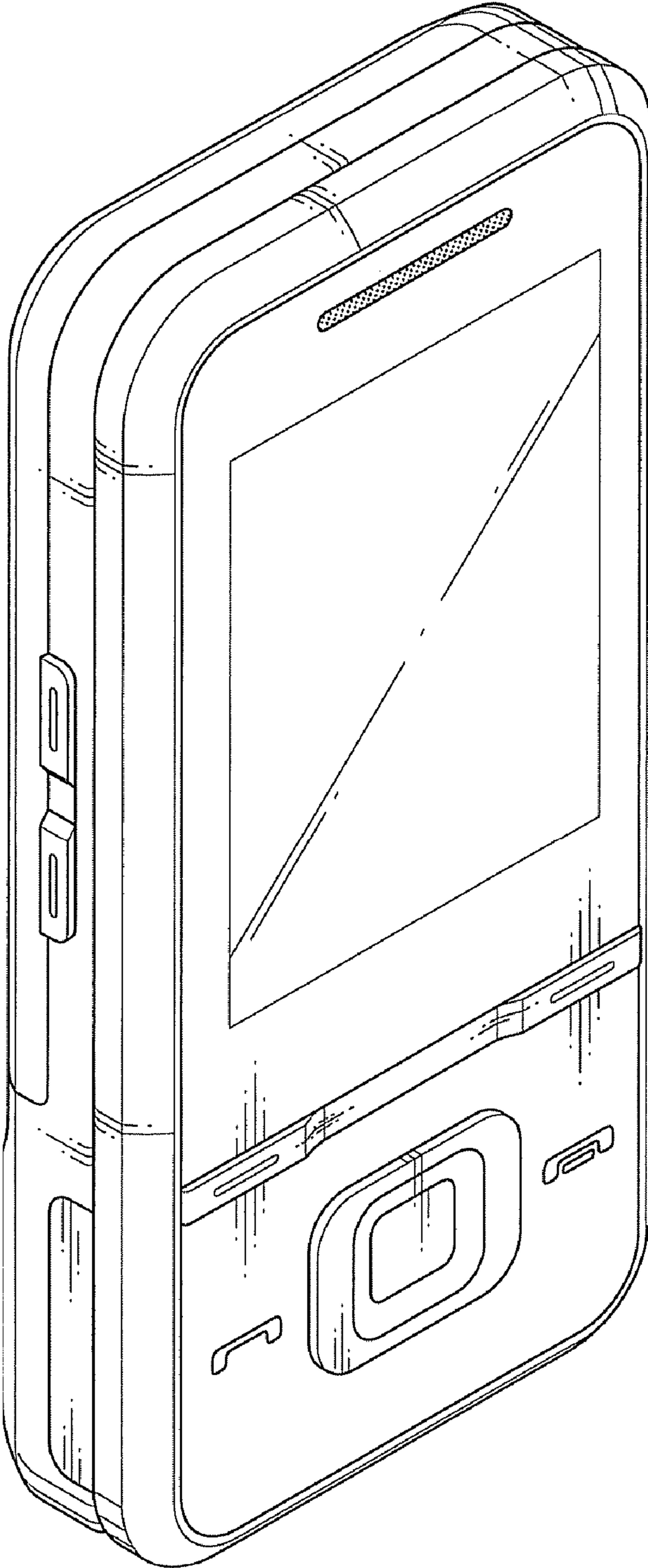

FIG.2

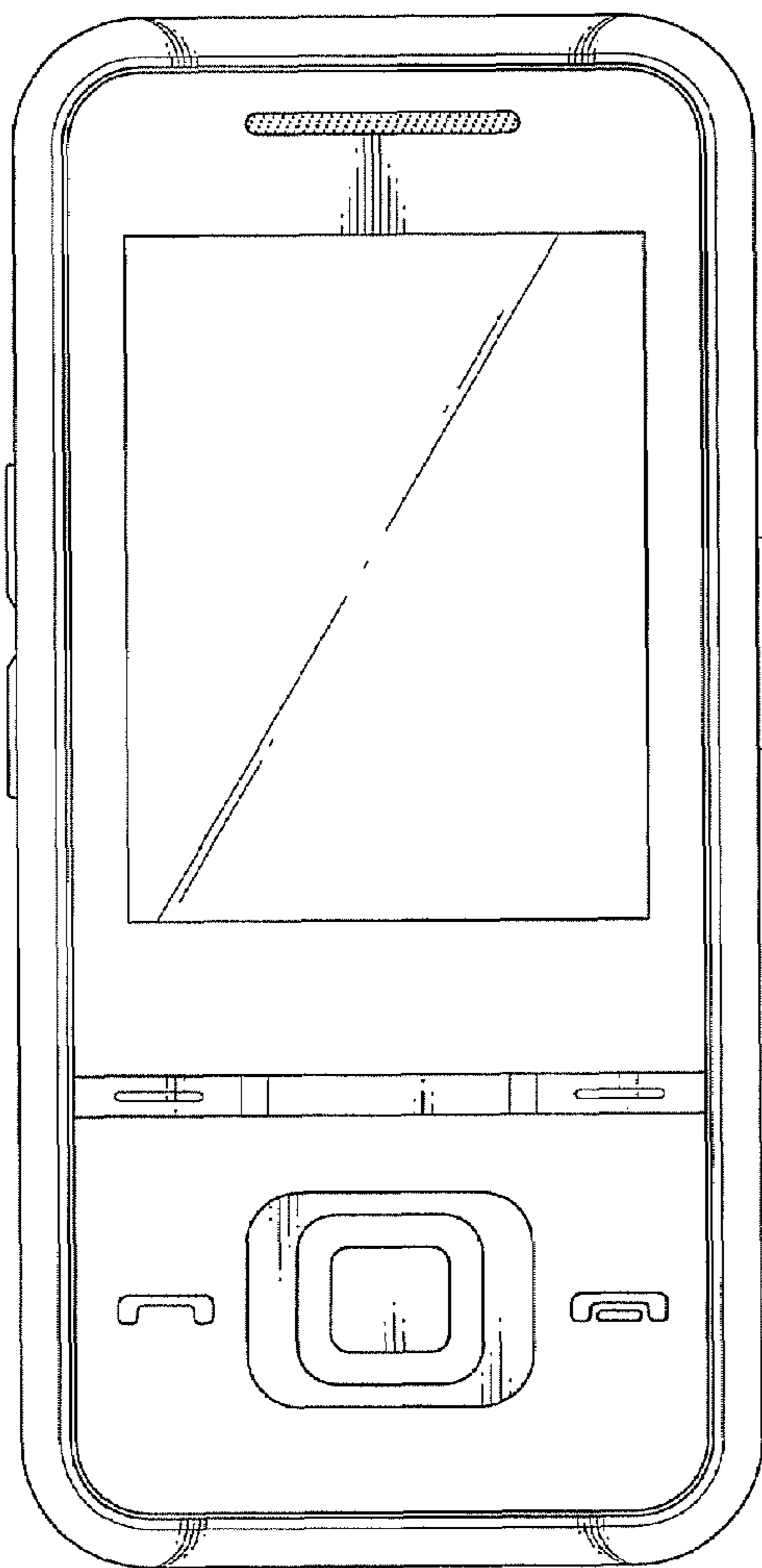

FIG.3

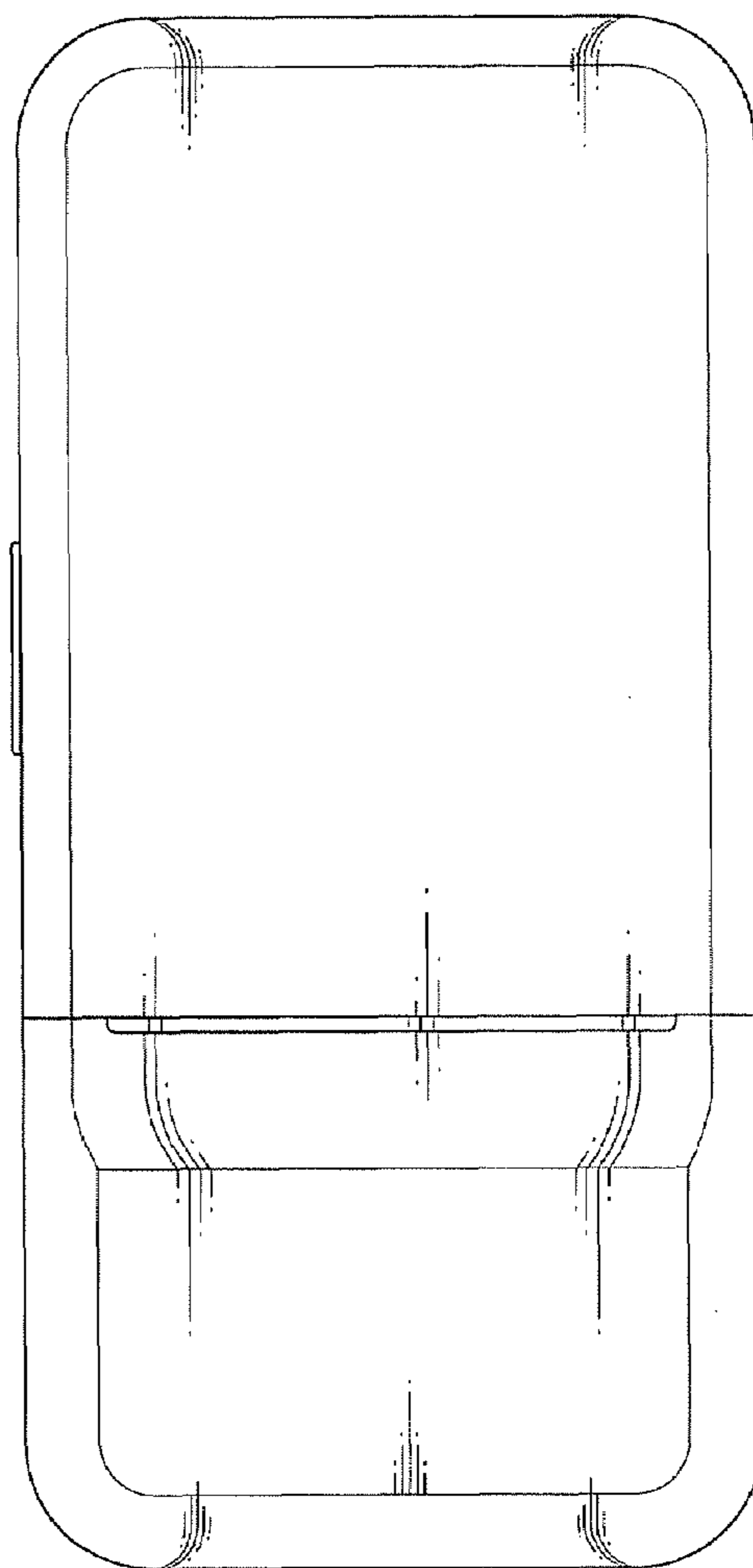

FIG. 4

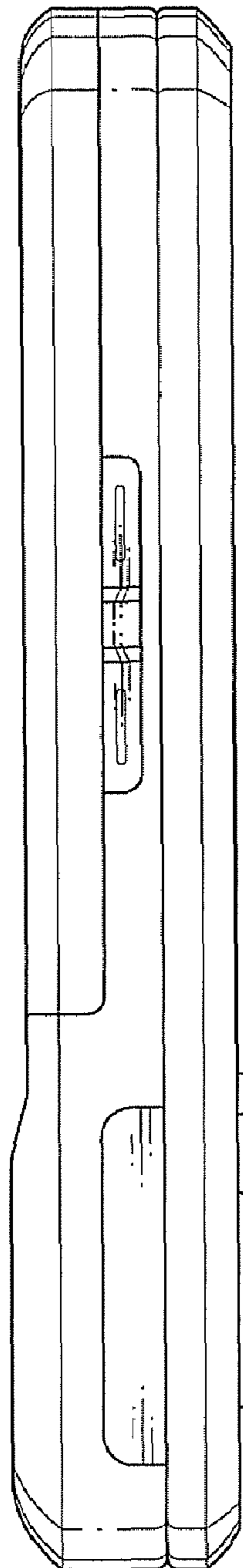

FIG. 5

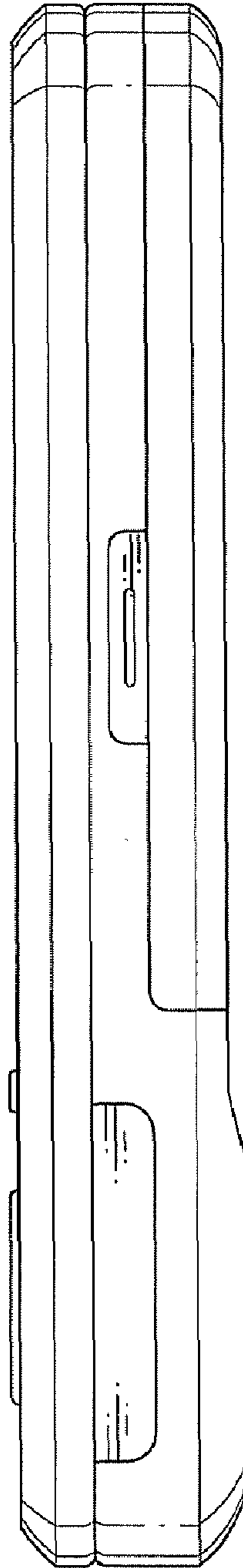

FIG. 6

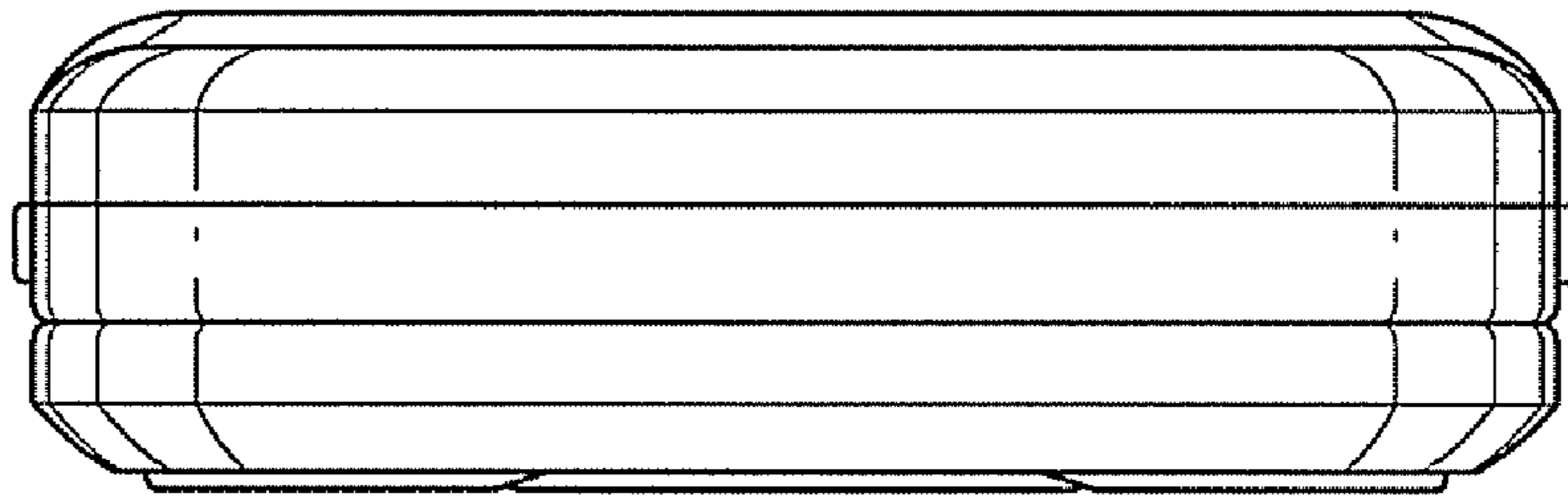

FIG. 7

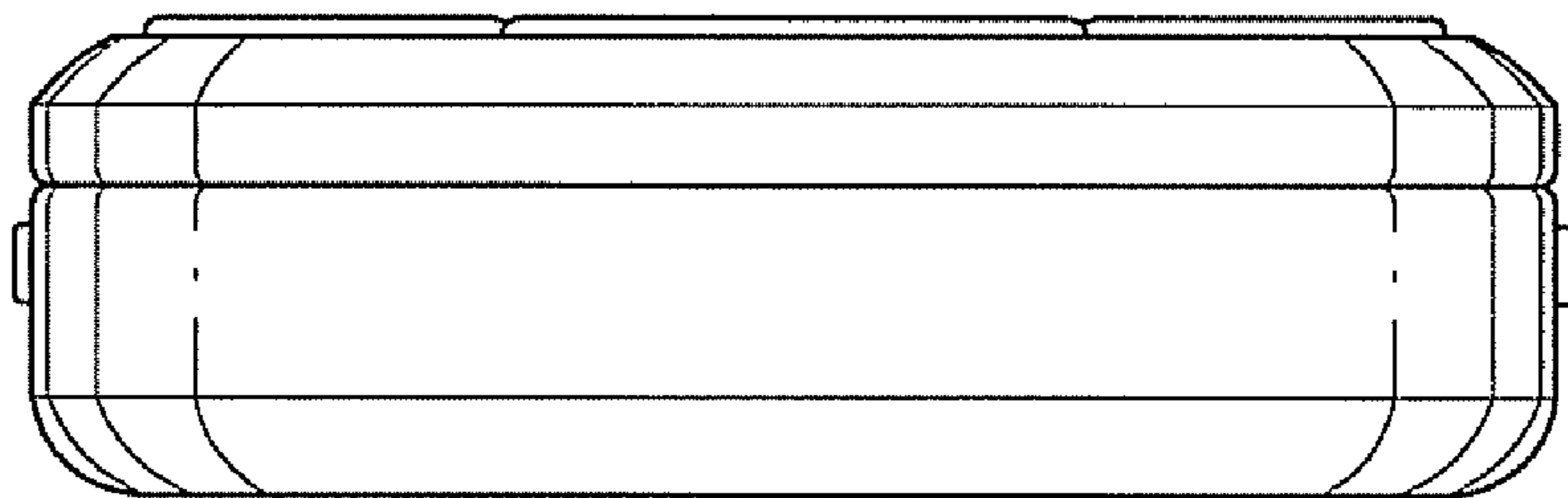

FIG. 8

